

## Building a SMARTER Tomorrow



# Company Profile



GIGAIPC, established in 2018 as an independent IPC-focused spin-off from GIGABYTE, is driven by a passion for technology and agile intuition of our customer's requirements. GIGAIPC has an exceptionally sophisticated Research & Development department, enabling us to keep up with the rapid pace of today's technology. Combined with our outstanding research and design ability, GIGAIPC also has an award-winning Taiwan-based manufacturing facility, synchronizing with GIGAIPC's R&D department to deliver high quality and reliable products. GIGAIPC is a young and energetic organization driven by surpassing our customer's expectations, and we promise to offer our customers not only high-quality computing platforms but also world-class service and support. As a result, GIGAIPC's service centers have been established in most major cities worldwide, and our global presence is still being actively expanding, all ready to offer the best service to our customers.



Company Profile/ Naming Rule

GIGAIPC is an Associate member of the Intel® Internet of Things Solutions Alliance.



## “Building a SMARTER Tomorrow”

The strengths of GIGAIPC are based on the advantages, skills and expertise we have built to realize this vision, including being customer focused and striving for high quality. GIGAIPC is determined to keep reinforcing these strengths as our principles to achieve maximum customer satisfaction.

## Key Advantages to work with GIGAIPC

<b>Technology</b>	<ol style="list-style-type: none"> <li>1. Intel®, AMD etc. Key vendor direct support</li> <li>2. Latest technical and over 10 years RD development experiences</li> <li>3. Large coverage rate of design verification</li> </ol>
<b>Flexibility</b>	<ol style="list-style-type: none"> <li>1. Huge off-the-shelf products combination and rich ODM/OEM experiences</li> <li>2. Multiple manufacturing sites for different high-mix and low-volume requirements</li> <li>3. Task-force team with multiple functions to align customer's requirements</li> </ol>
<b>Quality</b>	<ol style="list-style-type: none"> <li>1. Component IPC, audit and approval system</li> <li>2. Rich resources and equipments on design and manufacture quality system</li> <li>3. Emphasizing closed-loop of PDCA cycle for continuous improvement</li> </ol>
<b>Service</b>	<ol style="list-style-type: none"> <li>1. Worldwide RMA service coverage more than 80 service centers globally</li> </ol>
<b>Capability</b>	<ol style="list-style-type: none"> <li>1. Customization capability</li> <li>2. Direct field application engineer support and quick response</li> <li>3. Customized manufacturing process, quality control and delivery solutions</li> </ol>

## Motherboard's Naming Rule -

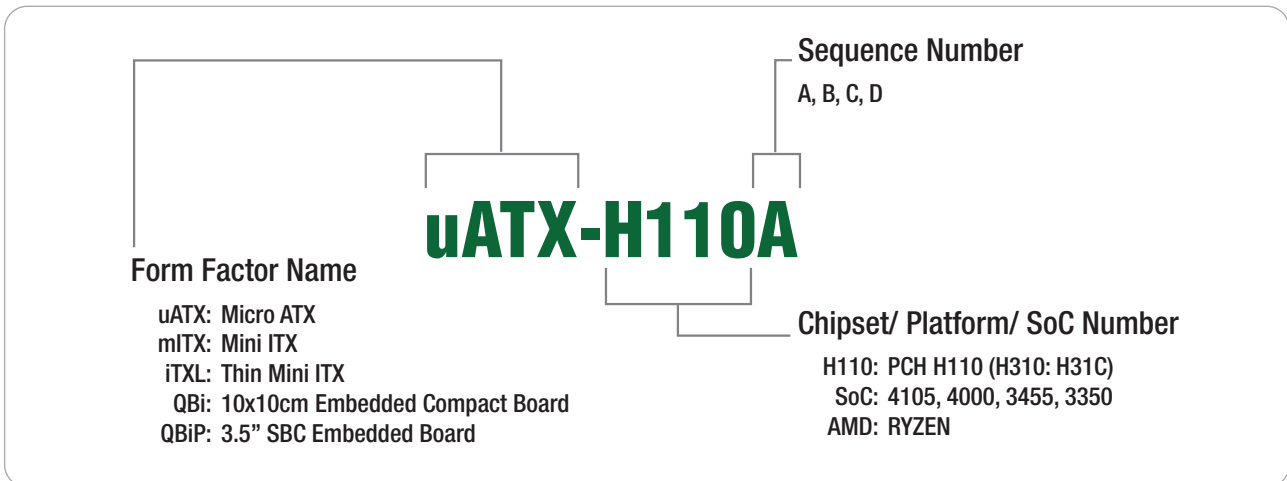

## System's Naming Rule -

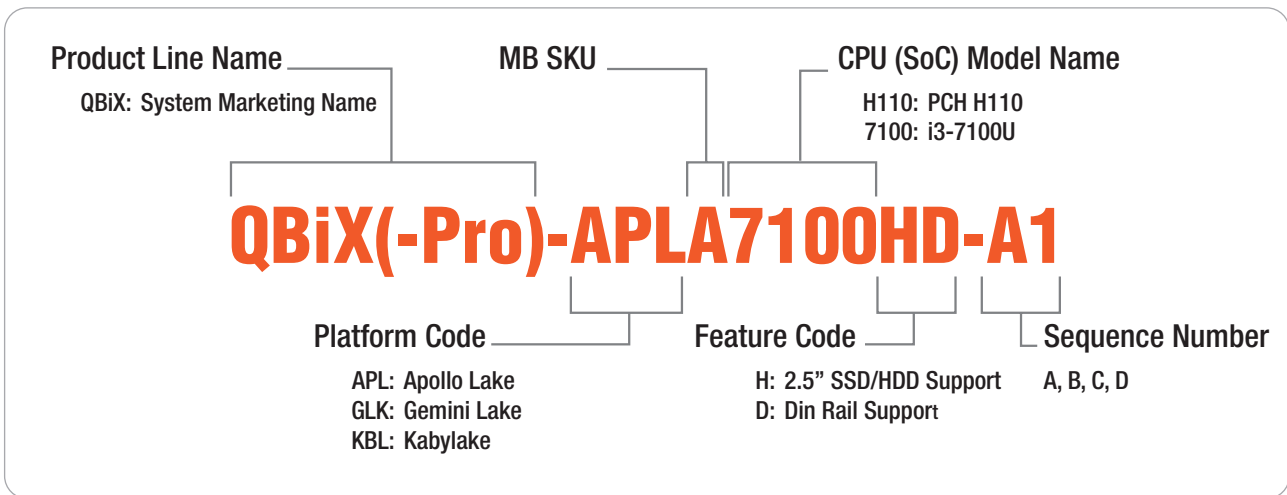

## Motherboard's Form Factor -

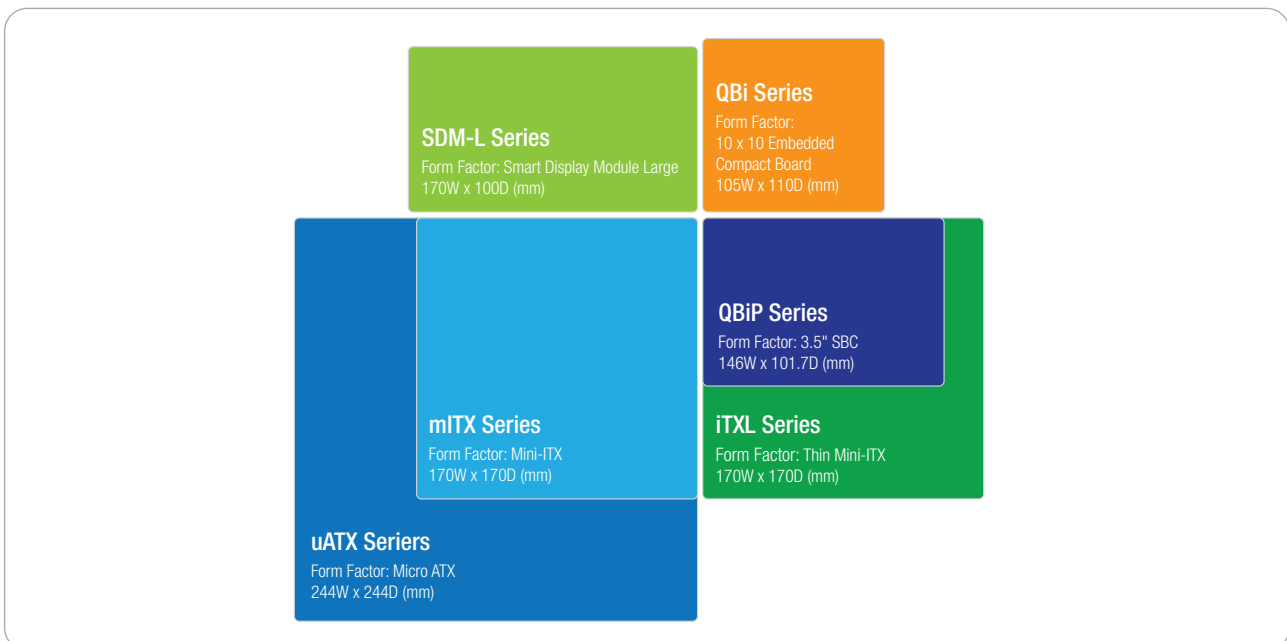

<b>Company Profile</b> .....	<b>1</b>
<b>Product’s Naming Rule</b> .....	<b>2</b>
<b>Index</b> .....	<b>3</b>
<b>QBiX Series</b> .....	<b>5</b>
QBiX-WHLA8265H-A1 .....	5
QBiX-WHLA8145H-A1 .....	5
QBiX-KBLA7100H-A1.....	5
QBiX2-GLKA5005H-A1 .....	6
QBiX-GLKA5005H-A1 .....	6
QBiX-APLA4200H-A1 .....	6
QBiX-GLKB4125-A1 .....	6
<b>QBiX-Pro Series</b> .....	<b>7</b>
QBiX-Pro-WHLA8565H-A1 .....	7
QBiX-Pro-WHLA8265H-A1 .....	7
QBiX-Pro-WHLA8145H-A1 .....	7
QBiX-Pro-WHLA8565H-A2.....	7
QBiX-Pro-WHLA8265H-A2 .....	7
QBiX-Pro-WHLA8145H-A2 .....	7
QBiX2-Pro-KBLB7100H-A1 .....	8
QBiX-Pro-KBLB7200H-A2 .....	8
QBiX-Pro-KBLB7100H-A1 .....	8
QBiX-Pro-KBLB7100H-B1 .....	8
QBiX-Pro-KBLB3965H-A1 .....	9
QBiX2-Pro-APLB4200H-A1.....	9
QBiX-Pro-APLB4200H-A1 .....	9
QBiX-Pro-APLB4200H-B1 .....	10
QBiX-Pro-BYTA1900H-A1 .....	10
QBiX-Pro-KBLB7100HD-A1 .....	11
QBiX-Pro-GLKA5005HD-A1.....	11
QBiX-Pro-BYTA1900HD-A1.....	11
QBiX-Pro-AMDA1605H-A1.....	12
QBiX-Pro-AMDA1606H-A1.....	12
<b>QBiX-Jumbo Series</b> .....	<b>13</b>
QBiX-JMB-CFLA310H-A1.....	13
QBiX-JMB-CFLA310HG-A1 .....	13
QBiX-JWB-SKYA110H-A1.....	14
QBiX-JWB-SKYB110H-A1.....	14
<b>Embedded IoT Series</b> .....	<b>15</b>
EL-30-4200 (rev. 1.0) .....	15
EL-30-3350 (rev. 1.0) .....	15
EL-20-3710-32G (rev. 1.0).....	15
EL-20-3060-32G (rev. 1.0) .....	15
<b>QBiX-Plus Series</b> .....	<b>16</b>
QBiX-Plus-KBLA7100-A1 .....	16
QBiX-Plus-APLA3450-A1.....	16

<b>QBiX-Lite Series</b> .....	<b>17</b>
QBiX-Lite-KBL7300S-A1 .....	17
QBiX-Lite-KBL7100S-A1 .....	17
QBiX-Lite-GLK4000S-A1.....	17
QBiX-Lite-GLK3350S-A1 .....	17
QBiX-Lite-AMDA1605H-A1 .....	17
<b>QBiX-ITX Series</b> .....	<b>18</b>
QBiX-ITX-CFLA310H-A1 .....	18
<b>Peripheral</b> .....	<b>18</b>
External Discrete GPU BOX Kit.....	18
<b>SDM-L Series</b> .....	<b>19</b>
SDM-7300L .....	19
SDM-7100L .....	19
SDM-4000L .....	19
SDM-3350L-QV.....	19
SDM-3350L-HW.....	20
SDM Docking Board .....	20
<b>Smart Whiteboard Series</b> .....	<b>22</b>
GSW-A55S7300-A1 .....	22
GSW-A55S7100-A1 .....	22
GSW-A55S4000-A1.....	22
GSW-A65S7300-A1 .....	23
GSW-A65S7100-A1 .....	23
GSW-A65S4000-A1 .....	23
GSW-A75S7300-A1 .....	24
GSW-A75S7100-A1 .....	24
GSW-A75S4000-A1 .....	24
<b>Micro-ATX Series</b> .....	<b>25</b>
uATX-H410A .....	25
uATX-Q370A .....	25
uATX-H370A .....	25
uATX-H310A .....	26
uATX-H110A .....	26
uATX-H81A .....	26
uATX-X570.....	27
uATX-RYZEN .....	27
<b>Mini-ITX Series</b> .....	<b>28</b>
mITX-Q370A.....	28
mITX-H310A .....	28
mITX-Q170A.....	28
mITX-H110A .....	29
mITX-H110B .....	29
mITX-4105A .....	30
mITX-4205A.....	30
mITX-1900A.....	31
mITX-1605A .....	31

## Thin Mini-ITX Series .....32

iTXL-Q370A.....	32
iTXL-Q170A.....	32
iTXL-H110C.....	32
iTXL-6100B.....	33
iTXL-3955A.....	33
iTXL-3350A.....	34
iTXL-1900A.....	34

## QBiP Series (3.5" SBC) .....35

QBiP-8565A.....	35
QBiP-8265A.....	35
QBiP-8145A.....	35
QBiP-7600A.....	35
QBiP-7200A.....	35
QBiP-7100A.....	35
QBiP-7100B.....	36
QBiP-5005B.....	36
QBiP-3965A.....	36
QBiP-4200A.....	37
QBiP-4200B.....	37
QBiP-4200C.....	37
QBiP-3350A.....	37
QBiP-E3940A.....	38
QBiP-1900A.....	38
QBiP-1605A.....	39
QBiP-1606A.....	39

## QBiP Wide Temperature Series..... 40

QBiP-7200AT.....	40
QBiP-7100AT.....	40
QBiP-E3940AT.....	40
QBiP-1900AT.....	40

## QBi Series (10 x 10 Embedded Compact Board) ...41

QBi-8565A.....	41
QBi-8265A.....	41
QBi-8145A.....	41
QBi-7100B.....	41
QBi-3965B.....	41
QBi-5005A.....	42
QBi-5005B.....	42
QBi-4000B.....	42
QBi-4200A.....	42
QBi-4200B.....	42
QBi-4125A.....	42

## QBiX Series



QBiX Series

Model Name	QBIX-WHLA8265H-A1	QBIX-WHLA8145H-A1	QBIX-KBLA7100H-A1
<b>Dimension</b>	138W x 118D x 74.2H (mm)	138W x 118D x 74.2H (mm)	138W x 118D x 74.2H (mm)
<b>CPU</b>	Intel® Core™ i5-8265U Processor, 14nm, 4 cores, 8 threads, up to 3.9 GHz, TDP 15W	Intel® Core™ i3-8145UE Processor, 14nm, 2 cores, 4 threads, up to 3.9 GHz, TDP 15W	Intel® Core™ i3-7100U Processor, 14nm, 2 cores, 4 threads, 2.4 GHz, TDP 15W
<b>Chipset</b>	SoC	SoC	SoC
<b>Memory</b>	2 x DDR4 SO-DIMM sockets, Max. Capacity 32 GB, Support Dual Channel DDR4 2400 MHz	2 x DDR4 SO-DIMM sockets, Max. Capacity 32 GB, Support Dual Channel DDR4 2400 MHz	2 x DDR4 SO-DIMM sockets, Max. Capacity 32 GB, Support Dual Channel DDR4 2133 MHz
<b>Ethernet</b>	2 x GbE LAN ports (Intel® I219V and Realtek® RTL8111HS)	2 x GbE LAN ports (Intel® I219V and Realtek® RTL8111HS)	1 x GbE LAN port (Intel® I219V)
<b>Graphic</b>	Integrated Graphics Processor - Intel® UHD Graphics 620: 2 x HDMI 1.4 2 independent display outputs	Integrated Graphics Processor - Intel® UHD Graphics 620: 2 x HDMI 1.4 2 independent display outputs	Integrated Graphics Processor - Intel® HD Graphics 620: 1 x HDMI 2.0 1 x mini Display Port 2 independent display outputs
<b>Audio</b>	Realtek® ALC269	Realtek® ALC269	Intel® Integrated Audio
<b>Storage</b>	1 x 2.5" HDD/SSD(SATA 6Gb/s)	1 x 2.5" HDD/SSD(SATA 6Gb/s)	1 x 2.5" HDD/SSD(SATA 6Gb/s)
<b>Expansion Slots</b>	1 x 2280 M.2 M-Key (PCIe x4, SATA 6Gb/s) 1 x 2230 M.2 E-Key 1 x Vertical USB 3.0	1 x 2280 M.2 M-Key (PCIe x4, SATA 6Gb/s) 1 x 2230 M.2 E-Key 1 x Vertical USB 3.0	1 x 2280 M.2 M-Key (PCIe x4, SATA 6Gb/s) 1 x 2230 M.2 E-Key
<b>Front I/O</b>	2 x USB 3.1 Gen2 1 x Power switch 2 x External Antenna Holes (Optional) 1 x Power & HDD LED 1 x COM port (RS-232/422/485)	2 x USB 3.1 Gen2 1 x Power switch 2 x External Antenna Holes (Optional) 1 x Power & HDD LED 1 x COM port (RS-232/422/485)	2 x USB 3.0 1 x Power switch 2 x External Antenna Holes (Optional) 1 x Power LED 1 x HDD LED
<b>Rear I/O</b>	2 x HDMI 2 x RJ45 LAN ports 2 x USB 3.1 Gen2 1 x Screw Type DC Jack	2 x HDMI 2 x RJ45 LAN ports 2 x USB 3.1 Gen2 1 x Screw Type DC Jack	1 x RJ45 LAN port 2 x USB 3.0 1 x HDMI 1 x Mini Display port 1 x COM port (RS-232) 1 x Screw Type DC Jack
<b>Side I/O</b>	—	—	—
<b>TPM</b>	—	—	—
<b>Power</b>	+9V~36VDC (Adapter 19V/90W)	+9V~36VDC (Adapter 19V/90W)	+12V~24VDC (Adapter 19V/65W)
<b>Operating Temp.</b>	0°C to 50°C	0°C to 50°C	0°C to 50°C
<b>Mounting</b>	Wall mount	Wall mount	Wall mount
<b>Ordering Information</b>	6BQB8265AMR-SI (Box packing)	6BQB8145AMR-SI (Box packing)	6BCKAAMR-SI (Box packing)
<b>Built-in Components</b>	—	—	—

## QBiX Series



Model Name	QBiX2-GLKA5005H-A1	QBiX-GLKA5005H-A1	QBiX-APLA4200H-A1	QBiX-GLKB4125-A1
<b>Dimension</b>	118W x 109.4D x 74.4H (mm)	118W x 109.4D x 54.4H (mm)	118W x 109.4D x 54.4H (mm)	118W x 109.4D x 44.4H (mm)
<b>CPU</b>	Intel® Pentium® Silver J5005 Processor, 14nm ,4 cores, 4 threads, up to 2.8 GHz, TDP 10W	Intel® Pentium® Silver J5005 Processor, 14nm, 4 cores, 4 threads, up to 2.8 GHz, TDP 10W	Intel® Pentium® Processor N4200, 14nm, 4 cores, 4 threads, up to 2.5 GHz, TDP 6W	Intel® Celeron® Processor J4125, 14nm, 4 cores, 4 threads, up to 2.7 GHz, TDP 10W
<b>Chipset</b>	SoC	SoC	SoC	SoC
<b>Memory</b>	1 x DDR4 SO-DIMM socket, Max. Capacity 8 GB, Support Single Channel DDR4 2400 MHz	1 x DDR4 SO-DIMM socket, Max. Capacity 8 GB, Support Single Channel DDR4 2400 MHz	1 x DDR3L SO-DIMM socket, Max. Capacity 8 GB, Support Single Channel DDR3L 1866 MHz	1 x DDR4 SO-DIMM socket, Max. Capacity 8 GB, Support Single Channel DDR4 2400 MHz
<b>Ethernet</b>	1 x GbE LAN port (Realtek® RTL8111HS)	1 x GbE LAN port (Realtek® RTL8111HS)	1 x GbE LAN port (Realtek® RTL8111HS)	2 x GbE LAN ports (Intel® I211AT and Realtek® RTL8111HS)
<b>Graphic</b>	Integrated Graphics Processor - Intel® UHD Graphics 605: 1 x HDMI 1.4 1 x VGA 2 independent display outputs	Integrated Graphics Processor - Intel® UHD Graphics 605: 1 x HDMI 1.4 1 x VGA 2 independent display outputs	Integrated Graphics Processor - Intel® HD Graphics 505: 1 x HDMI 1.4 1 x VGA 2 independent display outputs	Integrated Graphics Processor - Intel® UHD Graphics 600: 2 x HDMI 1.4 2 independent display outputs
<b>Audio</b>	Realtek® ALC891	Realtek® ALC891	Realtek® ALC255	Realtek® ALC269
<b>Storage</b>	1 x 2.5" HDD/SSD (SATA 6Gb/s)	1 x 2.5" HDD/SSD (SATA 6Gb/s)	1 x 2.5" HDD/SSD (SATA 6Gb/s)	—
<b>Expansion Slots</b>	1 x 2230 M.2 E-Key	1 x 2230 M.2 E-Key	1 x 2230 M.2 E-Key	1 x 2280 M.2 M-Key (SATA 6Gb/s) 1 x 2230 M.2 E-Key
<b>Front I/O</b>	2 x USB 3.0 2 x USB 2.0 3 x COM ports (RS-232) 1 x Headphone Jack 1 x Microphone Jack 1 x Power button with LED	2 x USB 3.0 1 x COM port (RS-232) 1 x Headphone Jack 1 x Microphone Jack 1 x Power button with LED	2 x USB 3.0 1 x Power button with LED 1 x Headphone Jack	2 x USB3.0 1 x COM Port (RS-232) 1 x Headphone Jack 1 x Power button with LED
<b>Rear I/O</b>	1 x RJ45 LAN port 2 x USB 3.0 1 x HDMI 1 x VGA 2 x External Antenna Holes (Optional) 2 x COM ports (RS-232) 1 x Screw Type DC Jack	1 x RJ45 LAN port 2 x USB 3.0 1 x HDMI 1 x VGA 2 x External Antenna Holes (Optional)	1 x RJ45 LAN port 2 x USB 3.0 1 x HDMI 1 x VGA 2 x External Antenna Holes (Optional)	2 x RJ45 LAN ports 2 x USB 3.0 2 x HDMI 2 x External Antenna Hole (Optional) 1 x Screw Type DC Jack
<b>Side I/O</b>	2 x USB 2.0 1 x RJ11 Cash Draw	1 x DC Jack	1 x DC Jack	—
<b>TPM</b>	—	—	—	—
<b>Power</b>	+19VDC (Adapter 19V/65W)	+12V~19VDC (Adapter 19V/65W)	+12V~24VDC (Adapter 19V/65W)	+12V~19VDC (Adapter 19V/65W)
<b>Operating Temp.</b>	0°C to 50°C	0°C to 50°C	0°C to 50°C	0°C to 50°C
<b>Mounting</b>	VESA 75/100	VESA 75/100	VESA 75/100	VESA 75/100
<b>Ordering Information</b>	6BQ25005AMR-SI (Box packing)	6BCGAAMR-SI (Box packing)	6BCBAAMR-SI (Box packing)	6BQB4125AMR-SI (Box packing)
<b>Built-in Components</b>	—	—	—	—

## QBiX-Pro Series



QBiX-Pro Series

Model Name	QBiX-Pro-WHLA8565H-A1 QBiX-Pro-WHLA8265H-A1 QBiX-Pro-WHLA8145H-A1	QBiX-Pro-WHLA8565H-A2 QBiX-Pro-WHLA8265H-A2 QBiX-Pro-WHLA8145H-A2
<b>Dimension</b>	178W x 125D x 52.7H (mm)	178W x 125D x 52.7H (mm)
<b>CPU</b>	Intel® Core™ i7-8565U Processor 14nm, 4 cores, 8 threads 1.8GHz, up to 4.6 GHz, TDP 15W Intel® Core™ i5-8265U Processor 14nm, 4 cores, 8 threads 1.6GHz, up to 3.9 GHz, TDP 15W Intel® Core™ i3-8145UE Processor 14nm, 2 cores, 2.2GHz up to 3.9 GHz, TDP 15W	Intel® Core™ i7-8565U Processor 14nm, 4 cores, 8 threads 1.8GHz, up to 4.6 GHz, TDP 15W Intel® Core™ i5-8265U Processor 14nm, 4 cores, 8 threads 1.6GHz, up to 3.9 GHz, TDP 15W Intel® Core™ i3-8145UE Processor 14nm, 2 cores, 2.2GHz up to 3.9 GHz, TDP 15W
<b>Chipset</b>	SoC	SoC
<b>Memory</b>	2 x DDR4 SO-DIMM sockets, Max. Capacity 32 GB, Support Dual Channel DDR4 2400 MHz	2 x DDR4 SO-DIMM sockets, Max. Capacity 32 GB, Support Dual Channel DDR4 2400 MHz
<b>Ethernet</b>	2 x GbE LAN ports (Intel® I219V and Intel® I211AT)	2 x GbE LAN ports (Intel® I219V and Intel® I211AT)
<b>Graphic</b>	Integrated Graphics Processor - Intel® UHD Graphics 620: 2 x HDMI 1.4 2 independent display outputs	Integrated Graphics Processor - Intel® UHD Graphics 620: 2 x HDMI 1.4 2 independent display outputs
<b>Audio</b>	Realtek® ALC269	Realtek® ALC269
<b>Storage</b>	1 x 2.5" HDD/SSD (SATA 6Gb/s)	1 x 2.5" HDD/SSD (SATA 6Gb/s)
<b>Expansion Slots</b>	1 x 2280 M.2 M-Key (PCIe x4, SATA 6Gb/s) 1 x 2230 M.2 E-Key 1 x Full-size Mini PCIe with SIM slot	1 x 2280 M.2 M-Key (PCIe x4, SATA 6Gb/s) 1 x 2230 M.2 E-Key 1 x Full-size Mini PCIe with SIM slot
<b>Front I/O</b>	2 x RJ45 LAN ports 4 x USB 3.1 Gen2 2 x HDMI 1 x Power button with LED 1 x HDD LED 1 x COM port (RS-232/422/485 & RI/5V/12V)	2 x RJ45 LAN ports 4 x USB 3.1 Gen2 2 x HDMI 1 x Power button with LED 1 x HDD LED 1 x COM port (RS-232/422/485 & RI/5V/12V)
<b>Rear I/O</b>	2 x USB 2.0 2 x COM ports (RS-232) 1 x GPIO (8 bits) 1 x Headphone Jack 1 x 3-pin Terminal Block	2 x USB 2.0 2 x COM ports (RS-232) 1 x GPIO (8 bits) 1 x Headphone Jack 1 x DC Jack Screw Type
<b>Side I/O</b>	2 x External Antenna Holes (Optional)	2 x External Antenna Holes (Optional)
<b>TPM</b>	—	—
<b>Power</b>	+9V~36VDC (Full Range)	+9V~36VDC (Adapter 19V/90W)
<b>Operating Temp.</b>	0°C to 50°C	0°C to 50°C
<b>Mounting</b>	Wall mount (Optional)	Wall mount (Optional)
<b>Ordering Information</b>	6BQP8565AMR-SI (Box packing) 6BQP8265AMR-SI (Box packing) 6BQP8145AMR-SI (Box packing)	6BQP8565AMR-SI (Box packing) 6BQP8265AMR-SI (Box packing) 6BQP8145AMR-SI (Box packing)
<b>Built-in COM portponents</b>	—	—



## QBiX-Pro Series



Model Name	QBiX2-Pro-KBLB7100H-A1	QBiX-Pro-KBLB7200H-A2	QBiX-Pro-KBLB7100H-A1	QBiX-Pro-KBLB7100H-B1
<b>Dimension</b>	178W x 125D x 90.2H (mm)	178W x 125D x 52.7H (mm)	178W x 125D x 52.7H (mm)	178W x 125D x 52.7H (mm)
<b>CPU</b>	Intel® Core™ i3-7100U Processor, 14nm, 2 cores, 4 threads, 2.4 GHz, TDP 15W	Intel® Core™ i5-7200U Processor, 14nm, 2 cores, 4 threads, up to 3.1 GHz, TDP 15W	Intel® Core™ i3-7100U Processor, 14nm, 2 cores, 4 threads, up to 2.4 GHz, TDP 15W	Intel® Core™ i3-7100U Processor, 14nm, 2 cores, 4 threads, up to 2.4 GHz, TDP 15W
<b>Chipset</b>	SoC	SoC	SoC	SoC
<b>Memory</b>	2 x DDR4 SO-DIMM sockets, Max. Capacity 32 GB, Support Dual Channel DDR4 2133 MHz	2 x DDR4 SO-DIMM sockets, Max. Capacity 32 GB, Support Dual Channel DDR4 2133 MHz	2 x DDR4 SO-DIMM sockets, Max. Capacity 32 GB, Support Dual Channel DDR4 2133 MHz	2 x DDR4 SO-DIMM sockets, Max. Capacity 32 GB, Support Dual Channel DDR4 2133 MHz
<b>Ethernet</b>	2 x GbE LAN ports (Intel® I219V and Intel® I211AT)	2 x GbE LAN ports (Intel® I219V and Intel® I211AT)	2 x GbE LAN ports (Intel® I219V and Intel® I211AT)	2 x GbE LAN ports (Intel® I219V and Intel® I211AT)
<b>Graphic</b>	Integrated Graphics Processor - Intel® HD Graphics 620: 1 x HDMI 2.0, 1 x Display Port 2 independent display outputs	Integrated Graphics Processor - Intel® HD Graphics 620: 1 x HDMI 2.0, 1 x Display Port 2 independent display outputs	Integrated Graphics Processor - Intel® HD Graphics 620: 1 x HDMI 2.0, 1 x Display Port 2 independent display outputs	Integrated Graphics Processor - Intel® HD Graphics 620: 1 x HDMI 2.0, 1 x Display Port 2 independent display outputs
<b>Audio</b>	Realtek® ALC269	Realtek® ALC269	Realtek® ALC269	Realtek® ALC269
<b>Storage</b>	1 x 2.5" HDD/SSD (SATA 6Gb/s)	1 x 2.5" HDD/SSD (SATA 6Gb/s)	1 x 2.5" HDD/SSD (SATA 6Gb/s)	1 x 2.5" HDD/SSD (SATA 6Gb/s)
<b>Expansion Slots</b>	1 x 2280 M.2 M-Key (PCIe x4, SATA 6Gb/s) 1 x 2230 M.2 E-Key 1 x Full-size Mini PCIe with SIM slot	1 x 2280 M.2 M-Key (PCIe x4, SATA 6Gb/s) 1 x 2230 M.2 E-Key 1 x Full-size Mini PCIe with SIM slot	1 x 2280 M.2 M-Key (PCIe x4, SATA 6Gb/s) 1 x 2230 M.2 E-Key 1 x Full-size Mini PCIe with SIM slot	1 x 2280 M.2 M-Key (PCIe x4, SATA 6Gb/s) 1 x 2230 M.2 E-Key 1 x Full-size Mini PCIe with SIM slot
<b>Front I/O</b>	2 x RJ45 LAN ports 4 x USB 3.0 1 x HDMI 1 x Display Port 1 x Power switch 1 x Power & HDD LED 1 x COM port (RS-232/422/485 & RI/5V/12V) 4 x COM ports (RS-232/422/485)	2 x RJ45 LAN ports 4 x USB 3.0 1 x HDMI 1 x Display Port 1 x Power switch 1 x Power & HDD LED 1 x COM port (RS-232/422/485 & RI/5V/12V)	2 x RJ45 LAN ports 4 x USB 3.0 1 x HDMI 1 x Display Port 1 x Power switch 1 x Power & HDD LED 1 x COM port (RS-232/422/485 & RI/5V/12V)	2 x RJ45 LAN ports 4 x USB 3.0 1 x HDMI 1 x Display Port 1 x Power switch 1 x Power & HDD LED 1 x COM port (RS-232/422/485 & RI/5V/12V)
<b>Rear I/O</b>	4 x USB 2.0 3 x COM ports (RS-232) 1 x GPIO (8 bits), SMBUS & Remote control 1 x 3-pin Terminal Block	2 x USB 2.0 3 x COM ports (RS-232) 1 x Screw Type DC Jack	2 x USB 2.0 3 x COM ports (RS-232) 1 x 3-pin Terminal Block	2 x USB 2.0 2 x COM ports (RS-232) 1 x GPIO (8 bits) 1 x Headphone Jack 1 x 3-pin Terminal Block
<b>Side I/O</b>	2 x External Antenna Holes (Optional)	2 x External Antenna Holes (Optional)	2 x External Antenna Holes (Optional)	2 x External Antenna Holes (Optional)
<b>TPM</b>	—	—	—	—
<b>Power</b>	+9V~36VDC (Full Range)	+9V~36VDC (Adapter 19V/65W)	+9V~36VDC (Full Range)	+9V~36VDC (Full Range)
<b>Operating Temp.</b>	0°C to 50°C	0°C to 50°C	0°C to 50°C	0°C to 50°C
<b>Mounting</b>	Wall mount (Optional)	Wall mount (Optional)	Wall mount (Optional)	Wall mount (Optional)
<b>Ordering Information</b>	9BQD7100AMR-SI (Box packing)	6BQP7200AMR-SI (Box packing)	6BCKACMR-SI (Box packing)	6BQP7100AMR-SI (Box packing)
<b>Built-in COM Portponents</b>	Memory: 4GB DDR4 SO-DIMM Storage: 128GB M.2 SSD	—	—	—

## QBiX-Pro Series



QBiX-Pro Series

Model Name	QBiX-Pro-KBLB3965H-A1	QBiX2-Pro-APLB4200H-A1	QBiX-Pro-APLB4200H-A1
<b>Dimension</b>	178W x 125D x 52.7H (mm)	178W x 125D x 90.2H (mm)	178W x 125D x 52.7H (mm)
<b>CPU</b>	Intel® Celeron® Processor 3965U, 14nm, 2 cores, 2 threads, up to 2.2 GHz, TDP 15W	Intel® Pentium® Processor N4200, 14nm, 4 cores, 4 threads, up to 2.5 GHz, TDP 6W	Intel® Pentium® Processor N4200, 14nm, 4 cores, 4 threads, up to 2.5 GHz, TDP 6W
<b>Chipset</b>	SoC	SoC	SoC
<b>Memory</b>	2 x DDR4 SO-DIMM sockets, Max. Capacity 32 GB, Support Dual Channel DDR4 2133 MHz	2 x DDR3L SO-DIMM sockets, Max. Capacity 8 GB, Support Dual Channel DDR3L 1866 MHz	2 x DDR3L SO-DIMM sockets, Max. Capacity 8 GB, Support Dual Channel DDR3L 1866 MHz
<b>Ethernet</b>	2 x GbE LAN ports (Intel® I219V and Intel® I211AT)	2 x GbE LAN ports (Intel® I211AT)	2 x GbE LAN ports (Intel® I211AT)
<b>Graphic</b>	Integrated Graphics Processor - Intel® HD Graphics 610: 1 x HDMI 2.0, 1 x Display Port 2 independent display outputs	Integrated Graphics Processor - Intel® HD Graphics 505: 1 x HDMI 1.4, 1 x VGA 2 independent display outputs	Integrated Graphics Processor - Intel® HD Graphics 505: 1 x HDMI 1.4, 1 x VGA 2 independent display outputs
<b>Audio</b>	Realtek® ALC269	Realtek® ALC269	Realtek® ALC269
<b>Storage</b>	1 x 2.5" HDD/SSD (SATA 6Gb/s)	1 x 2.5" HDD/SSD (SATA 6Gb/s)	1 x 2.5" HDD/SSD (SATA 6Gb/s)
<b>Expansion Slots</b>	1 x 2280 M.2 M-Key (SATA 6Gb/s) 1 x 2230 M.2 E-Key 1 x Full-size Mini PCIe with SIM slot	1 x 2242 M.2 M-Key (SATA 6Gb/s) 1 x Full-size Mini PCIe with SIM slot	1 x 2242 M.2 M-Key (SATA 6Gb/s) 1 x Full-size Mini PCIe with SIM slot
<b>Front I/O</b>	2 x RJ45 LAN ports 4 x USB 3.0 1 x HDMI 1 x Display Port 1 x Power switch 1 x Power & HDD LED 1 x COM port (RS-232/422/485 & RI/5V/12V)	2 x RJ45 LAN ports 2 x USB 3.0 1 x HDMI 1 x VGA 1 x Power switch 1 x Power & HDD LED 1 x Headphone Jack 4 x COM ports (RS-232/422/485 & RI/5V/12V)	2 x RJ45 LAN ports 2 x USB 3.0 1 x HDMI 1 x VGA 1 x Power switch 1 x Power & HDD LED 1 x Headphone Jack
<b>Rear I/O</b>	2 x USB 2.0 3 x COM ports (RS-232) 1 x 3-pin Terminal Block	6 x USB 2.0 1 x COM port (RS-232/422/485 & RI/5V/12V) 3 x COM ports (RS-232) 1 x GPIO (8 bits), SMBUS & Remote control 1 x 3-pin Terminal Block	2 x USB 2.0 1 x COM port (RS-232/422/485 & RI/5V/12V) 3 x COM ports (RS-232) 1 x 3-pin Terminal Block
<b>Side I/O</b>	2 x External Antenna Holes (Optional)	2 x External Antenna Holes (Optional)	2 x External Antenna Holes (Optional)
<b>TPM</b>	—	—	—
<b>Power</b>	+9V~36VDC (Full Range)	+9V~36VDC (Full Range)	+9V~36VDC (Full Range)
<b>Operating Temp.</b>	0°C to 50°C	0°C to 50°C	0°C to 50°C
<b>Mounting</b>	Wall mount (Optional)	Wall mount (Optional)	Wall mount (Optional)
<b>Ordering Information</b>	6BQP3965AMR-SI (Box packing)	9BQD4200AMR-SI (Box packing)	6BCBABMR-SI (Box packing)
<b>Built-in Components</b>	—	Memory: 4GB DDR3L SO-DIMM Storage: 128GB M.2 SSD	—

## QBiX-Pro Series



Model Name	QBiX-Pro-APLB4200H-B1	QBiX-Pro-BYTA1900H-A1
<b>Dimension</b>	178W x 125D x 52.7H (mm)	178W x 125D x 52.7H (mm)
<b>CPU</b>	Intel® Pentium® Processor N4200, 14nm, 4 cores, 4 threads, up to 2.5 GHz, TDP 6W	Intel® Celeron® Processor J1900, 22nm, 4 cores, 4 threads, up to 2.42 GHz, TDP 10W
<b>Chipset</b>	SoC	SoC
<b>Memory</b>	2 x DDR3L SO-DIMM sockets, Max. Capacity 8 GB, Support Dual Channel DDR3L 1866 MHz	1 x DDR3L SO-DIMM socket, Max. Capacity 8 GB, Support Single Channel DDR3L 1333 MHz
<b>Ethernet</b>	2 x GbE LAN ports (Intel® I211AT)	2 x GbE LAN ports (Intel® I211AT)
<b>Graphic</b>	Integrated Graphics Processor - Intel® HD Graphics 505: 1 x HDMI 1.4 1 x VGA 2 independent display outputs	Integrated Graphics Processor - Intel® HD Graphics: 1 x HDMI 1.4 1 x VGA 2 independent display outputs
<b>Audio</b>	Realtek® ALC269	Realtek® ALC269
<b>Storage</b>	1 x 2.5" HDD/SSD (SATA 6Gb/s)	1 x 2.5" HDD/SSD (SATA 3Gb/s)
<b>Expansion Slots</b>	1 x 2242 M.2 M-Key (SATA 6Gb/s) 1 x Full-size Mini PCIe with SIM slot	1 x 2280 M.2 M-Key (SATA 3Gb/s) 1 x Full-size Mini PCIe with SIM slot
<b>Front I/O</b>	2 x RJ45 LAN ports 2 x USB 3.0 1 x HDMI 1 x VGA 1 x Power switch 1 x Power & HDD LED 1 x Headphone Jack	2 x RJ45 LAN ports 1 x USB 3.0 1 x USB 2.0 1 x HDMI 1 x VGA 1 x Power switch 1 x Power & HDD LED 1 x Headphone Jack
<b>Rear I/O</b>	2 x USB 2.0 1 x COM port (RS-232/422/485 & RI/5V/12V) 2 x COM ports (RS-232) 1 x GPIO (8 bits) 1 x 3-pin Terminal Block	2 x USB 2.0 1 x COM port (RS-232 & RI/5V/12V) 3 x COM ports (RS-232) 1 x 3-pin Terminal Block
<b>Side I/O</b>	2 x External Antenna Holes (Optional)	2 x External Antenna Holes (Optional)
<b>TPM</b>	—	—
<b>Power</b>	+9V~36VDC (Full Range)	+9V~36VDC (Full Range)
<b>Operating Temp.</b>	0°C to 50°C	0°C to 50°C
<b>Mounting</b>	Wall mount (Optional)	Wall mount (Optional)
<b>Ordering Information</b>	6BQP4200AMR-SI (Box packing)	6BQP1900AMR-SI (Box packing)
<b>Built-in Components</b>	—	—

## QBiX-Pro Series



QBiX-Pro Series

Model Name	QBiX-Pro-KBLB7100HD-A1	QBiX-Pro-GLKA5005HD-A1	QBiX-Pro-BYTA1900HD-A1
<b>Dimension</b>	160W x 118D x 62.6H (mm)	160W x 118D x 62.6H (mm)	160W x 118D x 62.6H (mm)
<b>CPU</b>	Intel® Core™ i3-7100U Processor, 14nm, 2 cores, 4 threads, up to 2.40 GHz, TDP 15W	Intel® Pentium® Silver J5005 Processor, 14nm, 4 cores, 4 threads, up to 2.8 GHz, TDP 10W	Intel® Celeron® Processor J1900, 22nm, 4 cores, 4 threads, up to 2.42 GHz, TDP 10W
<b>Chipset</b>	SoC	SoC	SoC
<b>Memory</b>	2 x DDR4 SO-DIMM sockets, Max. Capacity 32 GB, Support Dual Channel DDR4 2133 MHz	1 x DDR4 SO-DIMM socket, Max. Capacity 8 GB, Support Single Channel DDR4 2400 MHz	1 x DDR3L SO-DIMM socket, Max. Capacity 8 GB, Support Single Channel DDR3L 1333 MHz
<b>Ethernet</b>	2 x GbE LAN ports (Intel® I219V and Intel® I211AT)	2 x GbE LAN ports (Intel® I211AT)	2 x GbE LAN ports (Intel® I211AT)
<b>Graphic</b>	Integrated Graphics Processor - Intel® HD Graphics 620 support 1 x HDMI 2.0 1 x Display Port 2 independent display outputs	Integrated Graphics Processor - Intel® UHD Graphics 605: 1 x HDMI 1.4 1 x VGA 2 independent display outputs	Integrated Graphics Processor - Intel® HD Graphics: 1 x HDMI 1.4 1 x VGA 2 independent display outputs
<b>Audio</b>	Realtek® ALC269	Realtek® ALC269	Realtek® ALC269
<b>Storage</b>	1 x 2.5" HDD/SSD (SATA 6Gb/s)	1 x 2.5" HDD/SSD (SATA 6Gb/s)	1 x 2.5" HDD/SSD (SATA 3Gb/s)
<b>Expansion Slots</b>	1 x 2280 M.2 M-Key (PCIe x4, SATA 6Gb/s) 1 x 2230 M.2 E-Key 1 x 3052 M.2 B-Key (Full-size mPCIe optional)	1 x 2280 M.2 M-Key (SATA 6Gb/s) 1 x 2230 M.2 E-Key 1 x Full-size miniPCIe with SIM slot 1 x Vertical USB 2.0	1 x 2280 M.2 M-Key (SATA 3Gb/s) 1 x Full-size Mini PCIe with SIM slot
<b>Front I/O</b>	2 x RJ45 LAN ports 4 x USB 3.0 2 x USB 2.0 1 x HDMI 1 x Display Port 1 x COM port (RS-232/422/485 & RI/5V/12V) 1 x COM ports (RS-232/422/485) 1 x Power switch 1 x HDD LED 1 x Headphone Jack	2 x RJ45 LAN ports 4 x USB 3.0 1 x HDMI 1 x VGA 2 x COM ports (RS-232/422/485 & RI/5V/12V) 1 x Power switch with LED 1 x WiFi/HDD LED 1 x Remote control pin 1 x Headphone Jack 1 x External Antenna Hole (Optional)	2 x RJ45 LAN ports 1 x USB 3.0 2 x USB 2.0 1 x HDMI 1 x VGA 1 x COM port (RS-232/422/485 & RI/5V/12V) 1 x COM port (RS-232) 1 x Power button 1 x HDD LED 1 x Headphone Jack
<b>Rear I/O</b>	1 x DIN Rail Mounting Support	1 x Din Rail Mounting Support	1 x Din Rail Mounting Support
<b>Side I/O</b>	1 x GPIO (8 bits) 1 x 3-pin Terminal Block 5 x External Antenna Hole (Optional)	1 x GPIO (8 bits) 1 x 3-pin Terminal Block 2 x COM ports (RS-232/422/485) 2 x External Antenna Holes (Optional)	1 x GPIO (8 bits) 1 x 3-pin Terminal Block 3 x External Antenna Holes (Optional)
<b>TPM</b>	—	—	—
<b>Power</b>	+9V~36VDC (Full Range)	+9V~36VDC (Full Range)	+9V~36VDC (Full Range)
<b>Operating Temp.</b>	0°C to 50°C	0°C to 50°C	0°C to 50°C
<b>Mounting</b>	DIN Rail/ Wall mount (Optional)	DIN Rail/ Wall mount (Optional)	DIN Rail/ Wall mount (Optional)
<b>Ordering Information</b>	6BQP7100CMR-SI (Box packing)	6BQP5005AMR-SI (Box packing)	6BQP1900BMR-SI (Box packing)
<b>Built-in Components</b>	—	—	—

## QBiX-Pro Series



Model Name	QBiX-Pro-AMDA1605H-A1	QBiX-Pro-AMDA1606H-A1
<b>Dimension</b>	178W x 125D x 52.7H (mm)	178W x 125D x 52.7H (mm)
<b>CPU</b>	AMD® RYZEN™ Embedded V1605B, 14nm, 4 cores, 8 threads, 2.0 GHz, up to 3.6 GHz, TDP 25W	AMD® RYZEN™ Embedded R1606G, 14nm, 2 cores, 4 threads, 2.6 GHz, up to 3.5 GHz, TDP 25W
<b>Chipset</b>	SoC	SoC
<b>Memory</b>	2 x DDR4 SO-DIMM sockets, Max. Capacity 32 GB, Support Dual Channel DDR4 2400 MHz	2 x DDR4 SO-DIMM sockets, Max. Capacity 32 GB, Support Dual Channel DDR4 2400 MHz
<b>Ethernet</b>	2 x GbE LAN port (Realtek® RTL8111HS)	2 x GbE LAN port (Realtek® RTL8111HS)
<b>Graphic</b>	Integrated Graphics Processor- AMD® Radeon™ Vega 8 Graphics: 4 x HDMI 2.0 4 independent display outputs	Integrated Graphics Processor- AMD® Radeon™ Vega 3 Graphics: 3 x HDMI 2.0 3 independent display outputs
<b>Audio</b>	Realtek® ALC269	Realtek® ALC269
<b>Storage</b>	1 x 2.5" HDD/SSD (SATA 6Gb/s)	1 x 2.5" HDD/SSD (SATA 6Gb/s)
<b>Expansion Slots</b>	1 x 2280 M.2 M-Key (PCIe x4, SATA 6Gb/s) 1 x 2230 M.2 E-Key 1 x Full-size Mini PCIe with SIM slot	1 x 2280 M.2 M-Key (PCIe x4, SATA 6Gb/s) 1 x 2230 M.2 E-Key 1 x Full-size Mini PCIe with SIM slot
<b>Front I/O</b>	2 x RJ45 LAN ports 2 x USB 3.0 4 x HDMI 1 x Power switch 1 x Power & HDD LED	2 x RJ45 LAN ports 2 x USB 3.0 3 x HDMI 1 x Power switch 1 x Power & HDD LED
<b>Rear I/O</b>	2 x USB 2.0 2 x COM ports (RS-232/422/485 & RI/5V/12V) 2 x COM ports (RS-232) 1 x Screw Type DC Jack	2 x USB 2.0 2 x COM ports (RS-232/422/485 & RI/5V/12V) 1 x GPIO (8 bits) 1 x Headphone Jack 1 x Screw Type DC Jack
<b>Side I/O</b>	2 x External Antenna Holes (Optional)	2 x External Antenna Holes (Optional)
<b>TPM</b>	Onboard TPM 2.0 security chip INFINEON SLB9665TT2.0	Onboard TPM 2.0 security chip INFINEON SLB9665TT2.0
<b>Power</b>	+9V~36VDC (Adapter 19V/65W)	+9V~36VDC (Adapter 19V/65W)
<b>Operating Temp.</b>	0°C to 50°C	0°C to 50°C
<b>Mounting</b>	Wall mount (Optional)	Wall mount (Optional)
<b>Ordering Information</b>	6BQP1605AMR-SI (Box packing)	6BQP1606AMR-SI (Box packing)
<b>Built-in Components</b>	—	—

## QBiX-Jumbo Series



Model Name	QBiX-JMB-CFLA310H-A1	QBiX-JMB-CFLA310HG-A1
<b>Dimension</b>	224W x 257D x 77H (mm)	224W x 343D x 146H (mm) (Discrete GFX Max. 250W)
<b>CPU</b>	Support for 8th/9th Generation Intel® Core™ i7/ i5/ i3 processors in the LGA1151 package, TDP under 65W	Support for 8th/9th Generation Intel® Core™ i7/ i5/ i3 processors in the LGA1151 package, TDP under 65W
<b>Chipset</b>	Intel® H310 Chipset	Intel® H310 Chipset
<b>Memory</b>	2 x DDR4 SO-DIMM sockets, Max. Capacity 32 GB, Support Dual Channel DDR4 2666/2400 MHz	2 x DDR4 SO-DIMM sockets, Max. Capacity 32 GB, Support Dual Channel DDR4 2666/2400 MHz
<b>Ethernet</b>	4 x GbE LAN ports (1 x Intel® I219V and 3 x Intel® I211AT)	4 x GbE LAN ports (1 x Intel® I219V and 3 x Intel® I211AT)
<b>Graphic</b>	Integrated Graphics Processor - Intel® HD Graphics: 1 x Display Port 1 x DVI-D 1 x VGA 2 independent display outputs	Integrated Graphics Processor - Intel® HD Graphics: 1 x Display Port 1 x DVI-D 1 x VGA 2 independent display outputs
<b>Audio</b>	Realtek® ALC269	Realtek® ALC269
<b>Storage</b>	3 x 2.5" HDD/SSD (SATA 6Gb/s) 1 x 2280 M.2 M-Key (SATA 6Gb/s) 1 x 2230 M.2 E-Key	3 x 2.5" HDD/SSD (SATA 6Gb/s) 1 x 2280 M.2 M-Key (SATA 6Gb/s) 1 x 2230 M.2 E-Key
<b>Expansion Slots</b>	1 x Full-size Mini PCIe with SIM slot	1 x Full-size Mini PCIe with SIM slot 1 x PCIe x1 (Gen3 x1) 1 x PCIe x16 (Gen3 x16)
<b>Front I/O</b>	1 x Power Switch/ Power/ HDD LED 3 x Audio Jacks (Line in, Line out, Mic in) 1 x Display Port 1 x DVI-D 1 x VGA 2 x COM ports (RS-232/422/485 & RI/5V/12V) 2 x COM ports (RS-232) 4 x RJ45 LAN ports 4 x USB 3.0 4 x USB 2.0 1 x 4-pin Terminal Block 2 x External Antenna Hole (Optional)	1 x Power Switch/ Power/ HDD LED 3 x Audio Jacks (Line in, Line out, Mic in) 1 x Display Port 1 x DVI-D 1 x VGA 2 x COM ports (RS-232/422/485 & RI/5V/12V) 2 x COM ports (RS-232) 4 x RJ45 LAN ports 4 x USB 3.0 4 x USB 2.0 1 x 4-pin Terminal Block 2 x External Antenna Hole (Optional)
<b>Rear I/O</b>	—	—
<b>Power</b>	+12V~48VDC -20°C to 50°C (CPU TDP 65W) -20°C to 60°C (CPU TDP 35W)	+24V~36VDC (Discrete GFX Support) -20°C to 50°C (CPU TDP 65W) -20°C to 60°C (CPU TDP 35W)
<b>Operating Temp.</b>	-20°C to 50°C (CPU TDP 35W, i3-8100T, Tj 82°C)	-20°C to 50°C (CPU TDP 35W, i3-8100T, Tj 82°C) -20°C to 60°C (With Optional Expansion Kit)
<b>Ordering Information</b>	9BQJH310AMR-SI (Box Packing)	9BQJH310AMR-SI 9BQJH310ASR-SI
<b>Build in Components</b>	CPU: i3-9100E Memory: DDR4 8GB	CPU: i3-9100E Memory: DDR4 8GB

## QBiX-Jumbo Series



Model Name	QBiX-JWB-SKYA110H-A1	QBiX-JWB-SKYB110H-A1
<b>Dimension</b>	273W x 203D x 91H(mm)	273W x 203D x 91H(mm)
<b>CPU</b>	Supports for 6/7th Generation Intel® Core™ i7/ i5/ i3, Pentium® & Celeron® processors, TDP under 35W	Supports for 6/7th Generation Intel® Core™ i7/ i5/ i3, Pentium® & Celeron® processors, TDP under 35W
<b>Chipset</b>	Intel® H110 Chipset	Intel® H110 Chipset
<b>Memory</b>	2 x DDR4 SO-DIMM sockets, Max. Capacity 32 GB, Support Dual Channel DDR4 2400/2133 MHz	2 x DDR4 SO-DIMM sockets, Max. Capacity 32 GB, Support Dual Channel DDR4 2400/2133 MHz
<b>Ethernet</b>	2 x GbE LAN ports (Intel® I219V and Intel® I211AT)	6 x GbE LAN ports (1 x Intel® I219V and 5 x Intel® I211AT)
<b>Graphic</b>	Integrated Graphics Processor - Intel® HD Graphics: 1 x HDMI 1.4 1 x Display Port 1 x VGA 1 x LVDS 2 independent display outputs	Integrated Graphics Processor - Intel® HD Graphics: 1 x HDMI 1.4 1 x VGA 2 independent display outputs
<b>Audio</b>	Realtek® ALC269	Realtek® ALC269
<b>Storage</b>	2 x 2.5" HDD/SSD (SATA 6Gb/s)	2 x 2.5" HDD/SSD (SATA 6Gb/s)
<b>Expansion Slots</b>	1 x 2280 M.2 M-Key (SATA 6Gb/s) 1 x Full/Half-size Mini PCIe with SIM slot	1 x 2280/2242 M.2 M-Key (SATA 6Gb/s) 1 x Full-size mSATA
<b>Front I/O</b>	1 x Power Switch 1 x Power & HDD LED 2 x Remote control header 4 x USB 2.0 4 x COM ports (RS-232/422/485) 1 x COM port (RS-232) 1 x GPIO (8 bit) 2 x External Antenna Hole (Optional)	1 x Power Switch 1 x Power & HDD LED 2 x Remote control header 4 x USB 2.0 4 x COM ports (RS-232/422/485) 2 x COM ports (RS-232/422/485 & RI/5V/12V) 1 x GPIO (8 bit) 2 x External Antenna Hole (Optional)
<b>Rear I/O</b>	3 x Audio Jacks (Line in, Line out, Mic in) 1 x VGA 1 x HDMI 1 x Display Port 1 x LVDS 1 x COM port (RS-232/422/485 & RI/5V/12V) 2 x RJ45 LAN ports 2 x USB 3.0 2 x USB 2.0 1 x 3-pin Terminal Block 2 x External Antenna Hole (Optional)	3 x Audio Jacks (Line in, Line out, Mic in) 1 x VGA 1 x HDMI 6 x RJ45 LAN ports 4 x USB 3.0 1 x 3-pin Terminal Block 2 x External Antenna Hole (Optional)
<b>Power</b>	+12V/+19V/+24VDC	+12V/+19V/+24VDC
<b>Operating Temp.</b>	0°C to 50°C	0°C to 50°C
<b>Ordering Information</b>	9BQJH110AMR-SI (Box packing)	9BQJH110BMR-SI (Box packing)
<b>Build in Components</b>	CPU: Intel® Core™ i3-7100T Processor, 3M Cache, 3.40 GHz Memory: 4GB DDR4 SO-DIMM Storage: 128GB, 2280 M.2 SSD	CPU: Intel® Core™ i3-7100T Processor, 3M Cache, 3.40 GHz Memory: 4GB DDR4 SO-DIMM Storage: 128GB, 2280 M.2 SSD

## Embedded IoT Series



Model Name	EL-30-4200 (rev. 1.0) EL-30-3350 (rev. 1.0)	EL-20-3710-32G (rev. 1.0) EL-20-3060-32G (rev. 1.0)
<b>Dimension</b>	140.8W x 107.5D x 29.5H (mm)	140.8W x 107.5D x 27H (mm)
<b>CPU</b>	Intel® Pentium® Processor N4200, 14nm, 4 cores, 4 threads, up to 2.5 GHz, TDP 6W (EL-30-4200) Intel® Celeron® Processor N3350, 14nm, 2 cores, 2 threads, up to 2.4 GHz, TDP 6W (EL-30-3350)	Intel® Pentium® processor N3710, 14nm, 4 cores, 4 threads, up to 2.56 GHz, TDP 6 W (EL-20-3710-32G) Intel® Celeron® processor N3060, 14nm, 2cores, 2 threads, up to 2.48 GHz, TDP 6 W (EL-20-3060-32G)
<b>Chipset</b>	FCBGA1296	FCBGA1296
<b>Memory</b>	2 x DDR3L SO-DIMM sockets, Max. Capacity 8 GB, Support Dual Channel DDR3L 1866 MHz	2 x DDR3L SO-DIMM sockets, Max. Capacity 8 GB, Support Dual Channel DDR3L 1600 MHz
<b>Ethernet</b>	2 x GbE LAN Port (Realtek® RTL8111HS)	2 x GbE LAN Port (Realtek® RTL8111HS)
<b>Graphic</b>	EL-30-4200: Integrated Graphics Processor - Intel® HD Graphics 505: 2 x HDMI 1.4 EL-30-3350: Integrated Graphics Processor - Intel® HD Graphics 500: 2 x HDMI 1.4 2 independent display outputs	Integrated Graphics Processor - Intel® HD Graphics 500: 2 x HDMI 1.4 2 independent display outputs
<b>Audio</b>	Realtek® ALC255	Realtek® ALC255
<b>Storage</b>	1 x eMMC 32GB	1 x eMMC 32GB
<b>Expansion Slots</b>	1 x Full-size Mini PCIe with SIM slot/ mSATA 1 x 2230 M.2 E-Key (Wi-Fi preinstalled) 1 x Zigbee module (Optional)	1 x Full-size Mini PCIe/mSATA 1 x Half-size Mini PCIe
<b>Front I/O</b>	4 x USB 3.0 1 x Micro SD Card Slot 1 x Audio Combo Jack (Headphone & Microphone) 1 x Power Button with LED 1 x HDD LED	4 x USB 3.0 1 x Micro SD Card Slot 1 x Audio Combo Jack (Headphone & Microphone) 1 x Power Button with LED 1 x HDD LED 3 x LED reserved for user configuration
<b>Rear I/O</b>	2 x RJ45 LAN ports 2 x HDMI 1 x COM port (RS-232/485)(RJ45 Type) 1 x DC Jack	2 x RJ45 LAN ports 2 x HDMI 1 x DC Jack
<b>Side I/O</b>	1 x COM port (RS-232)(Micro-B 5-pin) 1 x Kensington Lock 4 x External Antenna Hole	1 x USB 2.0 (Micro-B) 1 x COM port (RS-232)(Micro-B 5-pin) 1 x Kensington Lock 3 x External Antenna Hole
<b>TPM</b>	1 x TPM header	1 x TPM header
<b>Power</b>	+12V~19VDC (Adapter 19V/65W)	+12V~19VDC (Adapter 19V/65W)
<b>Operating Temp.</b>	0°C to 40°C	0°C to 40°C
<b>Ordering Information</b>	9BTCV9WMR-SI (Box packing) (EL-30-4200) 9BTCV8WMR-SI (Box packing) (EL-30-3350)	9BTCV5MR-SI (Box packing)(EL-20-3710-32G) 9BTCV7MR-SI (Box packing)(EL-20-3060-32G)
<b>Built-in Components</b>	Memory: 2 x 2GB DDR3L SO-DIMM ZigBee Module MS5168-M03 WiFi/BT Combo module: Intel® AC3168	Memory: 2 x 2GB DDR3L SO-DIMM (EL-20-3710-32G) Memory: 2 x 1GB DDR3L SO-DIMM (EL-20-3060-32G)



## QBiX-Plus Series



Model Name	QBiX-Plus-KBLA7100-A1	QBiX-Plus-APLA3450-A1
<b>Dimension</b>	180W x 117D x 36H (mm)	165W x 105D x 27H (mm)
<b>CPU</b>	Intel® Core™ i3-7100U Processor, 14nm, 2 cores, 4 threads, up to 2.40 GHz, TDP 15W	Intel® Celeron® Processor N3450, 14nm, 4 cores, 4 threads, up to 2.2 GHz, TDP 6W
<b>Chipset</b>	SoC	SoC
<b>Memory</b>	2 x DDR4 SO-DIMM sockets, Max. Capacity 32 GB, Support Dual Channel DDR4 2133 MHz	2 x DDR3L SO-DIMM sockets, Max. Capacity 8 GB, Support Dual Channel DDR3L 1866 MHz
<b>Ethernet</b>	2 x GbE LAN ports (Intel® I219LM and Intel® I210AT)	2 x GbE LAN ports (Realtek® RTL8111HS)
<b>Graphic</b>	Integrated Graphics Processor - Intel® HD Graphics 620: 2 x HDMI 2.0 2 independent display outputs	Integrated Graphics Processor - Intel® HD Graphics 500: 2 x HDMI 1.4 2 independent display outputs
<b>Audio</b>	Realtek® ALC255	Realtek® ALC255
<b>Storage</b>	—	—
<b>Expansion Slots</b>	1 x 2280 M.2 M-Key (PCIe x4, SATA 6Gb/s) 1 x 2230 M.2 E-Key 1 x Full-size Mini PCIe with SIM slot	1 x 2280 M.2 M-Key (SATA 6Gb/s) 1 x 2230 M.2 E-Key 1 x Full-size Mini PCIe with SIM slot
<b>Front I/O</b>	1 x USB3.1 Gen2 Type C 1 x USB3.1 Gen2 Type A 2 x USB3.0 1 x COM port (RS-232/422/485) 1 x Micro SD card slot 1 x Power button	2 x USB 3.0 1 x COM port (RS-232/422/485)(RJ45) 1 x Micro SD card slot 1 x Power button
<b>Rear I/O</b>	1 x Combo Audio Jack (Microphone & Headphone) 2 x RJ45 LAN ports 2 x USB 3.0 2 x HDMI 1 x DC Jack	1 x Combo Audio Jack (Microphone & Headphone) 2 x RJ45 LAN ports 2 x USB 3.0 2 x HDMI 1 x DC Jack
<b>Side I/O</b>	3 x External Antenna Hole (Optional)	3 x External Antenna Hole (Optional)
<b>TPM</b>	—	—
<b>Power</b>	+19VDC (Adapter 19V/90W)	+19VDC (Adapter 19V/65W)
<b>Operating Temp.</b>	0°C to 40°C	0°C to 50°C
<b>Mounting</b>	VESA 75/100	VESA 75/100
<b>Ordering Information</b>	9BCKABMR-SI (Box packing)	9BCBBAMR-SI (Box packing)
<b>Built-in Components</b>	Memory: 4GB DDR4 SO-DIMM Storage: 128GB M.2 SSD	Memory: 4GB DDR4 SO-DIMM Storage: 128GB M.2 SSD

## QBiX-Lite Series



## QBiX-Lite Series



Market Name	QBiX-Lite-KBL7300S-A1 QBiX-Lite-KBL7100S-A1 QBiX-Lite-GLK4000S-A1 QBiX-Lite-GLK3350S-A1	Market Name	QBiX-Lite-AMDA1605H-A1
<b>Dimension</b>	195W x 158D x 30H (mm)	<b>Dimension</b>	234W x 155D x 30H (mm)
<b>Support Model</b>	SDM-7300L (QBiX-Lite-KBL7300S-A1) SDM-7100L (QBiX-Lite-KBL7100S-A1) SDM-4000L (QBiX-Lite-GLK4000S-A1) SDM-3350L (QBiX-Lite-GLK3350S-A1)	<b>CPU</b>	AMD® RYZEN™ Embedded V1605B, 14nm, 4 cores, 8 threads, up to 3.6GHz, TDP 25W (Thermal Solution with Fan)
<b>Audio</b>	Intel® Integrated Audio	<b>Chipset</b>	SoC
<b>Storage</b>	1 x eMMC 32GB (SDM-4000L)	<b>Memory</b>	2 x DDR4 SO-DIMM sockets, Max. Capacity 32 GB, Support Dual Channel DDR4 2400 MHz
<b>Expansion Slots</b>	1 x 2280 M.2 M-Key (SATA 6Gb/s) 1 x 2230 M.2 E-Key 1 x Full-size mini PCIe (PCIe only)	<b>Ethernet</b>	2 x GbE LAN port (Realtek® RTL8111HS)
<b>Front I/O</b>	1 x Display Port 1 x RJ45 LAN port 4 x USB 3.0 1 x Power/ HDD LED 2 x External Antenna Hole (Optional) 1 x Reset button 1 x Power button	<b>Graphic</b>	Integrated Graphics Processor - AMD® Radeon™ Vega 8 Graphics: 4 x HDMI 2.0 4 independent display outputs EDID Emulation support with AMD utility
<b>Rear I/O</b>	1 x USB 3.0 1 x Display Port (Co-lay with front Display port) 1 x HDMI 1 x UART 1 x DC-Jack 1 x 2x2 Power connector	<b>Audio</b>	Realtek® ALC269
<b>Side I/O</b>	—	<b>Storage</b>	1 x 2.5" HDD/SSD Drive (Optional kit)
<b>TPM</b>	—	<b>Expansion Slots</b>	1 x 2280 M.2 M-Key (PCIe x4, SATA 6Gb/s) 1 x 2230 M.2 E-Key 1 x Full-size miniPCIe with SIM slot
<b>Power</b>	+12V~24VDC	<b>Front I/O</b>	2 x RJ45 LAN ports 2 x USB 3.0 2 x USB 2.0 4 x HDMI 1 x Power button with LED 1 x HDD LED 1 x Line out Phone Jack 1 x Screw Type DC Jack
<b>Operating Temp.</b>	0°C to 50°C	<b>Rear I/O</b>	1 x COM (RS-232/422/485 & RI/5V/12V) 2 x USB 2.0 2 x External Antenna Hole (Optional)
<b>Mounting</b>	Wall mount, VESA75/100 (Optional)	<b>Side I/O</b>	—
<b>Ordering Information</b>	6BSD4000AMR-SI (Box packing)	<b>TPM</b>	Onboard TPM 2.0 security chip INFINEON SLB9665TT2.0
<b>Built-in COM portponents</b>	—	<b>Power</b>	+9V~36VDC (Adapter 19V/65W)
		<b>Operating Temp.</b>	0°C to 50°C
		<b>Mounting</b>	Wall mount (Default), VESA75/100 (Optional)
		<b>Ordering Information</b>	6BQL1605AMR-SI (Box packing)
		<b>Built-in COM portponents</b>	—

## QBiX-ITX Series

## Peripheral



Market Name	QBiX-ITX-CFLA310H-A1	Model Name	External Discrete GPU BOX Kit
<b>Dimension</b>	210W x 200D x 58H (mm)	<b>Dimension</b>	172W x 370D x 102.5H (mm)
<b>Support Model</b>	mITX-Q370A mITX-H310A mITX-Q170A mITX-H110B mITX-1605A	<b>GFX Support</b>	Full Length 300mm Max 260W Graphic Card
<b>Chipset</b>	Refer to MB	<b>I/O</b>	4 x Ext. Mini SAS HD Port (PCIe x16)
<b>Storage Drive Bay</b>	1 x 2.5" Drive Bay	<b>PCIe support</b>	PCIe x16
<b>Expansion Slots</b>	Refer to Motherboard	<b>Power</b>	Flex ATX PSU 400W/500W (Optional)
<b>Front I/O</b>	4 x USB 2.0 1 x Power button with LED 1 x Power / HDD LED	<b>Operating Temp.</b>	0°C to 35°C
<b>Rear I/O</b>	2 x External Antenna hole Others are refer to Motherboard		
<b>Side I/O</b>	—		
<b>TPM</b>	Refer to Motherboard		
<b>Power</b>	Refer to Motherboard		
<b>Operating Temp.</b>	0°C to 50°C		
<b>Mounting</b>	Wall Mount, VESA 75/100		
<b>Ordering Information</b>	6BQIH310AMR-SI (Box packing)-MITX-H310A		
<b>Built-in COM portponents</b>	—		

## SDM-L Series



SDM-L Series

Model Name	SDM-7300L/ SDM-7100L	SDM-4000L	SDM-3350L-QV
<b>Dimensions</b>	SDM-Large, 175W x 100D (mm)	SDM-Large, 175W x 100D (mm)	SDM-Large, 175W x 100D (mm)
<b>CPU</b>	Intel® Core™ i5-7300U Processor, 14nm, 2 cores, 4 threads, up to 3.5 GHz, TDP 15W, VPro support (SDM-7300L) Intel® Core™ i3-7100U Processor, 14nm, 2 cores, 4 threads, up to 2.40 GHz, TDP 15W (SDM-7100L)	Intel® Celeron® Processor N4000, 14nm, 2 Cores, 2 threads, up to 2.6 GHz, TDP 6W	Intel® Celeron® Processor N3350, 14nm, 2 cores, 2 threads, up to 2.4 GHz, TDP 6W
<b>VPro</b>	Intel® vPro™ Platform Eligibility (SDM-7300L)	—	—
<b>Memory</b>	2 x DDR4 SO-DIMM sockets, Max. Capacity 32 GB, Support Dual Channel DDR4 2133 MHz	2 x DDR4 SO-DIMM sockets, Max. Capacity 8 GB, Support Dual Channel DDR4 2400 MHz	2 x DDR3L SO-DIMM sockets, Max. Capacity 8 GB, Support Dual Channel DDR3L 1866 MHz
<b>Ethernet</b>	1 x GbE LAN port (7300L: Intel® I219LM) (7100L: Intel® I219V)	1 x GbE LAN port (Realtek® RTL8111HS)	1 x GbE LAN port (Realtek® RTL8111HS)
<b>Graphic</b>	Integrated Graphics Processor - Intel® HD Graphics 620: 1 x HDMI 2.0 (SDM), 1 x Display Port (Rear/SDM) 2 independent display outputs	Integrated Graphics Processor - Intel® UHD Graphics 600: 1 x HDMI 2.0 (SDM), 1 x Display Port (Rear/SDM) 2 independent display outputs	Integrated Graphics Processor - Intel® HD Graphics 500: 1 x HDMI 1.4 (SDM), 2 x Display Port (Rear/SDM) 3 independent display outputs (Full HD)
<b>Audio</b>	Intel® Integrated Audio	Intel® Integrated Audio	Intel® Integrated Audio
<b>Storage</b>	—	1 x eMMC 32GB	1 x eMMC 32GB
<b>Expansion Slots</b>	1 x 2280 M.2 M-Key (PCIe x4, SATA 6Gb/s) 1 x 2230 M.2 E-Key	1 x 2280 M.2 M-Key (SATA 6Gb/s) 1 x 2230 M.2 E-Key	1 x 2280 M.2 M-Key (SATA 6Gb/s) 1 x 2230 M.2 E-Key
<b>Internal I/O</b>	—	—	—
<b>Rear I/O</b>	1 x Display Port 1 x RJ45 LAN port 4 x USB 3.0 1 x Power/ HDD LED 2 x External Antenna Holes (Optional) 1 x Reset button 1 x Power button	1 x Display Port 1 x RJ45 LAN port 4 x USB 3.0 1 x Power/ HDD LED 2 x External Antenna Holes (Optional) 1 x Reset button 1 x Power button	1 x Display Port 1 x RJ45 LAN port 4 x USB 3.0 1 x Power/ HDD LED 2 x External Antenna Holes (Optional) 1 x Reset button 1 x Power button
<b>TPM</b>	1 x TPM header	—	—
<b>Operating Temp.</b>	0°C to 55°C	0°C to 55°C	0°C to 55°C
<b>Ordering Information</b>	9MFLP3ALMR-SI (Box packing) (SDM-7300L) 9MFLP3ALNR-SI (Bulk packing) (SDM-7100L) 9MFLP3ALMR-SI (Box packing) (SDM-7100L)	9MZGLKALNR-SI (Bulk packing) 9MZGLKALMR-SI (Box packing)	9MAPLKALMR-SI (Box packing)
<b>Built-in Components</b>	—	—	—

## SDM-L Series



Model Name	SDM-3350L-HW	SDM Docking Board
<b>Dimensions</b>	SDM-Large, 175W x 100D (mm)	190W x 62D (mm)
<b>CPU</b>	Intel® Celeron® Processor N4000, 14nm, 2 Cores, 2 threads, up to 2.6 GHz, TDP 6W	—
<b>VPro</b>	—	—
<b>Memory</b>	2 x DDR4 SO-DIMM sockets, Max. Capacity 8 GB, Support Dual Channel DDR4 2400 MHz	—
<b>Ethernet</b>	1 x GbE LAN port (Realtek® RTL8111HS)	—
<b>Graphic</b>	Integrated Graphics Processor - Intel® UHD Graphics 600: 1 x HDMI 2.0 (SDM), 1 x Display Port (Rear/SDM) 2 independent display outputs	—
<b>Audio</b>	Intel® Integrated Audio	—
<b>Storage</b>	1 x eMMC 32GB	—
<b>Expansion Slots</b>	1 x 2280 M.2 M-Key (SATA 6Gb/s) 1 x 2230 M.2 E-Key	1 x PCIe x8 slot for SDM-L module 1 x Full-size mini PCIe (PCIe only)
<b>Internal I/O</b>	—	2 x I2C 1 x GPIO 1 x COM (TX, RX only)
<b>Rear I/O</b>	1 x Display Port 1 x RJ45 LAN port 4 x USB 3.0 1 x Power/ HDD LED 2 x External Antenna Holes (Optional) 1 x Reset button 1 x Power button	1 x USB 3.0 1 x Display Port 1 x HDMI 1 x UART 1 x DC-Jack 1 x 2x2 Power connector
<b>TPM</b>	—	—
<b>Operating Temp.</b>	0°C to 55°C	0°C to 60°C
<b>Ordering Information</b>	9MZGLKALNR-SI (Bulk packing) 9MZGLKALMR-SI (Box packing)	—
<b>Built-in Components</b>	—	—



## Smart Whiteboard Collaboartion without Limits

### Smart Whiteboard

Nowadays, video conferences have become the new norm in the corporate world. For which devices that allow smooth collaboration within the colleagues inside the same meeting room, or in another continent, have become more and more important.

Smart whiteboards are one of those devices that allow collaboration among colleagues, enhance brainstorming for new ideas, and encourage creativity. With the Smart Whiteboard, forget about the restrictions of cables and physical space, and explore ideas without limit.

GIGAIPC has made the perfect integration of Intel® Smart Display Module (Intel® SDM) Solution with a high-quality touch screen of 55", 65", 75" and the OS to create a smooth user-friendly Smart Whiteboard solution, that needs just to plug in and play. Even the most traditional colleague will be able to interact with the whiteboard right away.

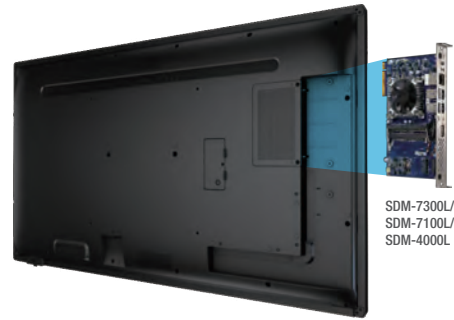

SDM-7300L/  
SDM-7100L/  
SDM-4000L

### Collaboration Without Borders

With Smart Whiteboard you will not only have a beautiful display to present your latest report, but you will have a powerful computing machine to allow you enrich your presentations with latest digital media, and most importantly connect to the internet and present to everyone in your corporation around the world and inside your office. Allowing them to participate and comment on your presentation in real-time: Asking the right questions at the right time has never been easier than with the Smart Whiteboard.

### Upgrade Your Team's Creativity

Have you ever been in a brainstorming session, that has been restricted because there is not enough space in the whiteboard? Well, that is now a thing of the past with a smart whiteboard. With its unlimited canvas, you can all brainstorm together by drawing, handwriting, inserting graphs, tables, or images on the same canvas at the same time. Even if you are not in the same meeting room or the same country. People can simultaneously access files, edit contents, annotate, save and share documents through this smartboard to finish the brainstorming process effectively.



#### Quick Deployment

Smart Digital Module (SDM) is pre-installed with Windows. It is inserted in the touch panel and ready to use.



#### Economic Feasibility

Easy to upgrade by switching new version of SDM. It's not necessary to replace the whole solution to save high costs.



#### Massive Device Collaboration

Users connect Smart Whiteboard to desktop, notebook or even smart devices, such as IOS and Android with a single application.



#### Multi-User Capability

Users access files and edit contents, handwriting and graphics at the same time when they are in different physical places.



#### Real-Time Interaction

Suitable for Online-to-Offline meetings with audio and video peripherals connected.

## Smart Whiteboard Series

SDM Display Product Photo		
SDM-L Photo		
<b>Market Name</b>	<b>GSW-A55S7300-A1 GSW-A55S7100-A1</b>	<b>GSW-A55S4000-A1</b>
<b>Dimension</b>	1271.7W x 742.6D x 74.66D (mm)	1271.7W x 742.6H x 74.66D (mm)
<b>Display Size</b>	55"	55"
<b>Brightness</b>	430 cd/m2	430 cd/m2
<b>Contrast Ratio</b>	1200:1	1200:1
<b>Viewing Angel</b>	H:175°/ V:175°	H:175°/ V:175°
<b>Display Resolution</b>	3840 x 2160 (16:9)	3840 x 2160 (16:9)
<b>Touch technology</b>	IR, 20 points	IR, 20 points
<b>Speaker</b>	10W x 2	10W x 2
<b>CPU</b>	Intel® Core™ i5-7300U Processor , 14nm, 2 cores, 4 threads, up to 3.5 GHz, TDP 15W Intel® Core™ i3-7100U Processor , 14nm, 2 cores, 4 threads, 2.40 GHz, TDP 15W	Intel® Celeron® Processor N4000, 14nm, 2 Cores, 2 threads, up to 2.6 GHz, TDP 6W
<b>vPro</b>	Intel® vPro™ Platform Eligility (with i5-7300U)	—
<b>Memory</b>	2 x DDR4 SO-DIMM sockets, Max. Capacity 32 GB, Support Dual Channel DDR4 2133 MHz	2 x DDR4 SO-DIMM sockets, Max. Capacity 8 GB, Support Dual Channel DDR4 2400 MHz
<b>Ethernet</b>	1 x GbE LAN port (7300: Intel® I219LM) (7200/7100: Intel® I219V)	1 x GbE LAN port (Realtek® RTL8111HS)
<b>Graphic</b>	Integrated Graphics Processor - Intel® HD Graphics 620: 1 x HDMI 2.0 (SDM), 1 x Display Port (Rear/SDM) 2 independent display outputs	Integrated Graphics Processor - Intel® UHD Graphics 600: 1 x HDMI 2.0 (SDM), 1 x Display Port (Rear/SDM) 2 independent display outputs
<b>Audio</b>	Intel® Integrated Audio	Intel® Integrated Audio
<b>Storage</b>	—	1 x eMMC 32GB
<b>Expansion Slots</b>	1 x 2280 M.2 M-Key (PCIe x4, SATA 6Gb/s) 1 x 2230 M.2 E-Key	1 x 2280 M.2 M-Key (SATA 6Gb/s) 1 x 2230 M.2 E-Key
<b>SDM I/O</b>	1 x Display Port 1 x RJ45 LAN port 4 x USB 3.0 1 x Power/ HDD LED 2 x External Antenna Hole (Optional) 1 x Reset button 1 x Power button	1 x Display Port 1 x RJ45 LAN port 4 x USB 3.0 1 x Power/ HDD LED 2 x External Antenna Hole (Optional) 1 x Reset button 1 x Power button
<b>TPM</b>	1 x TPM header	—
<b>Dispy I/O</b>	2 x HDMI 2.0 1 x Display Port 1.2 1 x DVI-D 1 x VGA 1 x PC Audio In 1 x SPDIF Out 1 x HDMI 2.0 Output (Duplicate mode support) 1 x RS-232 1 x USB 2.0 Type B (USB Touch Bypass)	2 x HDMI 2.0 1 x Display Port 1.2 1 x DVI-D 1 x VGA 1 x PC Audio In 1 x SPDIF Out 1 x HDMI 2.0 Output (Duplicate mode support) 1 x RS-232 1 x USB 2.0 Type B (USB Touch Bypass)
<b>Mounting</b>	400 x 400 (mm)	400 x 400 (mm)
<b>Power</b>	AC 100V ~ 240V	AC 100V ~ 240V
<b>Operating Temp.</b>	0°C to 40°C	0°C to 40°C
<b>Ordering Information</b>	—	—
<b>Built-in COM portponents</b>	Memory: 16GB DDR4 SO-DIMM Storage: 256GB M.2 SSD	Memory: 8GB DDR4 SO-DIMM Storage: 256GB M.2 SSD

## Smart Whiteboard Series

SDM Display Product Photo		
SDM-L Photo		
<b>Market Name</b>	<b>GSW-A65S7300-A1 GSW-A65S7100-A1</b>	<b>GSW-A65S4000-A1</b>
<b>Dimension</b>	1494.3W x 907.4H x 80.2D (mm)	1494.3W x 907.4H x 80.2D (mm)
<b>Display Size</b>	65"	65"
<b>Brightness</b>	430 cd/m2	430 cd/m2
<b>Contrast Ratio</b>	1200:1	1200:1
<b>Viewing Angel</b>	H:175°/ V:175°	H:175°/ V:175°
<b>Display Resolution</b>	3840 x 2160 (16:9)	3840 x 2160 (16:9)
<b>Touch technology</b>	IR, 20 points	IR, 20 points
<b>Speaker</b>	15W x 2	15W x 2
<b>CPU</b>	Intel® Core™ i5-7300U Processor , 14nm, 2 cores, 4 threads, up to 3.5 GHz, TDP 15W Intel® Core™ i3-7100U Processor , 14nm, 2 cores, 4 threads, 2.40 GHz, TDP 15W	Intel® Celeron® Processor N4000, 14nm, 2 Cores, 2 threads, up to 2.6 GHz, TDP 6W
<b>vPro</b>	Intel® vPro™ Platform Eligibility (with i5-7300U)	—
<b>Memory</b>	2 x DDR4 SO-DIMM sockets, Max. Capacity 32 GB, Support Dual Channel DDR4 2133 MHz	2 x DDR4 SO-DIMM sockets, Max. Capacity 8 GB, Support Dual Channel DDR4 2400 MHz
<b>Ethernet</b>	1 x GbE LAN port (7300: Intel® I219LM) (7200/7100: Intel® I219V)	1 x GbE LAN port (Realtek® RTL8111HS)
<b>Graphic</b>	Integrated Graphics Processor - Intel® HD Graphics 620: 1 x HDMI 2.0 (SDM), 1 x Display Port (Rear/SDM) 2 independent display outputs	Integrated Graphics Processor - Intel® UHD Graphics 600: 1 x HDMI 2.0 (SDM), 1 x Display Port (Rear/SDM) 2 independent display outputs
<b>Audio</b>	Intel® Integrated Audio	Intel® Integrated Audio
<b>Storage</b>	—	1 x eMMC 32GB
<b>Expansion Slots</b>	1 x 2280 M.2 M-Key (PCIe x4, SATA 6Gb/s) 1 x 2230 M.2 E-Key	1 x 2280 M.2 M-Key (SATA 6Gb/s) 1 x 2230 M.2 E-Key
<b>SDM I/O</b>	1 x Display Port 1 x RJ45 LAN port 4 x USB 3.0 1 x Power/ HDD LED 2 x External Antenna Hole (Optional) 1 x Reset button 1 x Power button	1 x Display Port 1 x RJ45 LAN port 4 x USB 3.0 1 x Power/ HDD LED 2 x External Antenna Hole (Optional) 1 x Reset button 1 x Power button
<b>TPM</b>	1 x TPM header	—
<b>Dispy I/O</b>	2 x HDMI 2.0, 1 x Display Port 1.2 1 x DVI-D 1 x VGA 1 x PC Audio In 1 x SPDIF Out 1 x HDMI 2.0 Output (Duplicate mode support) 1 x RS-232 1 x USB 2.0 Type B (USB Touch Bypass)	2 x HDMI 2.0, 1 x Display Port 1.2 1 x DVI-D 1 x VGA 1 x PC Audio In 1 x SPDIF Out 1 x HDMI 2.0 Output (Duplicate mode support) 1 x RS-232 1 x USB 2.0 Type B (USB Touch Bypass)
<b>Mounting</b>	400 x 400 (mm)	400 x 400 (mm)
<b>Power</b>	AC 100V ~ 240V	AC 100V ~ 240V
<b>Operating Temp.</b>	0°C to 40°C	0°C to 40°C
<b>Ordering Information</b>	—	—
<b>Built-in COM portponents</b>	Memory: 16GB DDR4 SO-DIMM Storage:256GB M.2 SSD	Memory: 8GB DDR4 SO-DIMM Storage:256GB M.2 SSD



## Smart Whiteboard Series

SDM Display Product Photo		
SDM-L Photo		
<b>Market Name</b>	<b>GSW-A75S7300-A1</b> <b>GSW-A75S7100-A1</b>	<b>GSW-A75S4000-A1</b>
<b>Dimension</b>	1715.5W x 1031.7H x 80.8D (mm)	1715.5W x 1031.7H x 80.8D (mm)
<b>Display Size</b>	75"	75"
<b>Brightness</b>	430 cd/m2	430 cd/m2
<b>Contrast Ratio</b>	1200:1	1200:1
<b>Viewing Angel</b>	H:175°/ V:175°	H:175°/ V:175°
<b>Display Resolution</b>	3840 x 2160 (16:9)	3840 x 2160 (16:9)
<b>Touch technology</b>	IR, 20 points	IR, 20 points
<b>Speaker</b>	15W x 2	15W x 2
<b>CPU</b>	Intel® Core™ i5-7300U Processor , 14nm, 2 cores, 4 threads, up to 3.5 GHz, TDP 15W Intel® Core™ i3-7100U Processor , 14nm, 2 cores, 4 threads, 2.40 GHz, TDP 15W	Intel® Celeron® Processor N4000, 14nm, 2 Cores, 2 threads, up to 2.6 GHz, TDP 6W
<b>vPro</b>	Intel® vPro™ Platform Eligibility (with i5-7300U)	—
<b>Memory</b>	2 x DDR4 SO-DIMM sockets, Max. Capacity 32 GB, Support Dual Channel DDR4 2133 MHz	2 x DDR4 SO-DIMM sockets, Max. Capacity 8 GB, Support Dual Channel DDR4 2400 MHz
<b>Ethernet</b>	1 x GbE LAN port (7300: Intel® I219LM) (7200/7100: Intel® I219V)	1 x GbE LAN port (Realtek® RTL8111HS)
<b>Graphic</b>	Integrated Graphics Processor - Intel® HD Graphics 620: 1 x HDMI 2.0 (SDM), 1 x Display Port (Rear/SDM) 2 independent display outputs	Integrated Graphics Processor - Intel® UHD Graphics 600: 1 x HDMI 2.0 (SDM), 1 x Display Port (Rear/SDM) 2 independent display outputs
<b>Audio</b>	Intel® Integrated Audio	Intel® Integrated Audio
<b>Storage</b>	—	1 x eMMC 32GB
<b>Expansion Slots</b>	1 x 2280 M.2 M-Key (PCIe x4, SATA 6Gb/s) 1 x 2230 M.2 E-Key	1 x 2280 M.2 M-Key (SATA 6Gb/s) 1 x 2230 M.2 E-Key
<b>SDM I/O</b>	1 x Display Port 1 x RJ45 LAN port 4 x USB 3.0 1 x Power/ HDD LED 2 x External Antenna Hole (Optional) 1 x Reset button 1 x Power button	1 x Display Port 1 x RJ45 LAN port 4 x USB 3.0 1 x Power/ HDD LED 2 x External Antenna Hole (Optional) 1 x Reset button 1 x Power button
<b>TPM</b>	1 x TPM header	—
<b>Dispy I/O</b>	2 x HDMI 2.0, 1 x Display Port 1.2 1 x DVI-D 1 x VGA 1 x PC Audio In 1 x SPIDIF Out 1 x HDMI 2.0 Output (Duplicate mode support) 1 x RS-232 1 x USB 2.0 Type B (USB Touch Bypass)	2 x HDMI 2.0, 1 x Display Port 1.2 1 x DVI-D 1 x VGA 1 x PC Audio In 1 x SPIDIF Out 1 x HDMI 2.0 Output (Duplicate mode support) 1 x RS-232 1 x USB 2.0 Type B (USB Touch Bypass)
<b>Mounting</b>	600 x 400 (mm)	600 x 400 (mm)
<b>Power</b>	AC 100V ~ 240V	AC 100V ~ 240V
<b>Operating Temp.</b>	0°C to 40°C	0°C to 40°C
<b>Ordering Information</b>	—	—
<b>Built-in COM portponents</b>	Memory: 16GB DDR4 SO-DIMM Storage: 256GB M.2 SSD	Memory: 8GB DDR4 SO-DIMM Storage: 256GB M.2 SSD

## Micro-ATX Series



Micro-ATX Series

Model Name	uATX-H410A	uATX-Q370A	uATX-H370A
<b>CPU</b>	Support for 10th Generation Intel® Core™ i7/i5/i3, Pentium® & Celeron® processors, TDP under 65W	Support for 8th/9th Generation Intel® Core™ i7/i5/i3, Pentium® & Celeron® processors, TDP under 95W	Support for 8th/9th Generation Intel® Core™ i7/i5/i3, Pentium® & Celeron® processors, TDP under 65W
<b>Socket</b>	LGA 1200	LGA 1151	LGA 1151
<b>Chipset</b>	Intel® H410 Chipset	Intel® Q370 Chipset	Intel® H370 Chipset
<b>Memory</b>	2 x DDR4 DIMM sockets, Max. Capacity 32 GB, Support Dual Channel DDR4 2933/2666 MHz	4 x DDR4 DIMM sockets, Max. Capacity 64 GB, Support Dual Channel DDR4 2666/2400 MHz	4 x DDR4 DIMM sockets, Max. Capacity 64 GB, Support Dual Channel DDR4 2666/2400 MHz
<b>Ethernet</b>	2 x GbE LAN port (Intel® I219V and Realtek® RTL8111HS)	2 x GbE LAN port (Intel® I219V and Realtek® RTL8111HS)	2 x GbE LAN port (Intel® I219V and Realtek® RTL8111HS)
<b>Graphic</b>	Integrated Graphics Processor - depends on CPU: 1 x HDMI 1.4, 1 x DVI-D, 1 x VGA 2 independent display outputs	Integrated Graphics Processor - depends on CPU: 1 x HDMI 1.4, 1 x DVI-D, 1 x VGA 3 independent display outputs	Integrated Graphics Processor - depends on CPU: 1 x HDMI 1.4, 1 x DVI-D, 1 x VGA 3 independent display outputs
<b>Audio</b>	Realtek® ALC888S	Realtek® ALC888S	Realtek® ALC888S
<b>Storage</b>	4 x SATA 6Gb/s ports	6 x SATA 6Gb/s ports (RAID 0/1/5/10)	6 x SATA 6Gb/s ports (RAID 0/1/5/10)
<b>Expansion Slots</b>	1 x PCIe x16 (Gen3 x16) - CPU 1 x PCIe x4 (Gen3 x2) 2 x PCIe x1 (Gen3 x1)	1 x PCIe x16 (Gen3 x16) 1 x PCIe x4 (Gen3 x4) 2 x PCIe x1 (Gen3 x1) 1 x 2280/2260 M.2 M-Key (PCIe x4)	1 x PCIe x16 (Gen3 x16) 1 x PCIe x4 (Gen3 x4) 2 x PCIe x1 (Gen3 x1) 1 x 2280/2260 M.2 M-Key (PCIe x4)
<b>Internal I/O</b>	1 x 24-pin ATX main power connector 1 x 8-pin ATX 12V power connector 1 x CPU fan header 2 x System fan headers 1 x Front panel header 1 x Front panel audio header 4 x USB 2.0 headers 3 x COM headers (RS-232) 1 x Clear CMOS jumper 1 x Buzzer	1 x 24-pin ATX main power connector 1 x 8-pin ATX 12V power connector 1 x CPU fan header 2 x System fan headers 1 x Front panel header 1 x Front panel audio header 4 x USB 2.0 headers 2 x USB 3.0 headers 3 x COM headers (RS-232) 1 x Clear CMOS jumper 1 x Buzzer	1 x 24-pin ATX main power connector 1 x 8-pin ATX 12V power connector 1 x CPU fan header 2 x System fan headers 1 x Front panel header 1 x Front panel audio header 4 x USB 2.0 headers 2 x USB 3.0 headers 3 x COM headers (RS-232) 1 x Clear CMOS jumper 1 x Buzzer
<b>Rear I/O</b>	3 x Audio Jacks (Line in, Line out, Mic in) 1 x COM port (RS-232) 1 x HDMI 1 x DVI-D 1 x VGA 2 x RJ45 LAN port 4 x USB 3.0	3 x Audio Jacks (Line in, Line out, Mic in) 1 x COM port (RS-232) 1 x HDMI 1 x DVI-D 1 x VGA 2 x RJ45 LAN port 3 x USB 3.0 1 x USB 3.1 Gen2	3 x Audio Jacks (Line in, Line out, Mic in) 1 x COM port (RS-232) 1 x HDMI 1 x DVI-D 1 x VGA 2 x RJ45 LAN ports 3 x USB 3.0 1 x USB 3.1 Gen2
<b>TPM</b>	Onboard TPM 2.0 security chip INFINEON SLB9665VQ2.0	Onboard TPM 2.0 security chip INFINEON SLB9665VQ2.0	Onboard TPM 2.0 security chip INFINEON SLB9665VQ2.0
<b>Operating Temp.</b>	0°C to 60°C	0°C to 60°C	0°C to 60°C
<b>Ordering Information</b>	9MH410AMNR-SI	9MQ370AMNR-SI (Box packing)	9MCH37AMNR-SI (Bulk packing)

## Micro-ATX Series



Model Name	uATX-H310A	uATX-H110A	uATX-H81A
<b>CPU</b>	Support for 8th/9th Generation Intel® Core™ i7/i5/i3, Pentium® & Celeron® processors, TDP under 65W	Supports for 6/7th Generation Intel® Core™ i7/i5/i3, Pentium® & Celeron® processors, TDP under 65W	Supports for 4th Generation Intel® Core™ i7/i5/i3, Pentium® & Celeron® processors, TDP under 85W
<b>Socket</b>	LGA 1151	LGA 1151	LGA 1150
<b>Chipset</b>	Intel® H310 Chipset	Intel® H110 Chipset	Intel® H81 Chipset
<b>Memory</b>	2 x DDR4 DIMM sockets, Max. Capacity 32 GB, Support Dual Channel DDR4 2666/2400 MHz	2 x DDR4 DIMM sockets, Max. Capacity 32 GB, Support Dual Channel DDR4 2400/2133 MHz	2 x DDR3 SO-DIMM slots, Max. Capacity 16 GB, Support Dual Channel DDR3 1600/1333 MHz
<b>Ethernet</b>	2 x GbE LAN port (Intel® I219V and Realtek® RTL8111HS)	2 x GbE LAN port (Intel® I219LM and Realtek® RTL8111HS)	2 x GbE LAN ports (Realtek® RTL8111G)
<b>Graphic</b>	Integrated Graphics Processor - depends on CPU: 1 x HDMI 1.4, 1 x DVI-D, 1 x VGA 2 independent display outputs	Integrated Graphics Processor - depends on CPU: 1 x HDMI 1.4, 1 x DVI-D, 1 x VGA 2 independent display outputs	Integrated Graphics Processor - depends on CPU: 1 x DVI-D, 1 x VGA, 1 x LVDS 2 independent display outputs
<b>Audio</b>	Realtek® ALC888S	Realtek® ALC888S	Realtek® ALC269
<b>Storage</b>	4 x SATA 6Gb/s ports	4 x SATA 6Gb/s ports	2 x SATA 3Gb/s ports
<b>Expansion Slots</b>	1 x PCIe x16 (Gen3 x16) 1 x PCIe x4 (Gen2 x2) 2 x PCIe x1 (Gen2 x1)	1 x PCIe x16 (Gen3 x16) 1 x PCIe x4 (Gen2 x2) 2 x PCIe x1 (Gen2 x1)	1 x PCIe x16 (Gen3 x16) 1 x PCIe x1 (Gen2 x1) 2 x PCI 1 x Half-size Mini PCIe 1 x Full-size Mini PCIe
<b>Internal I/O</b>	1 x 24-pin ATX main power connector 1 x 8-pin ATX 12V power connector 1 x CPU fan header 2 x System fan headers 1 x Front panel header 1 x Front panel audio header 4 x USB 2.0 headers 3 x COM headers (RS-232) 1 x Clear CMOS jumper 1 x Buzzer	1 x 24-pin ATX main power connector 1 x 8-pin ATX 12V power connector 1 x CPU fan header 2 x System fan headers 1 x Front panel header 1 x Front panel audio header 2 x USB 2.0 headers 3 x COM headers (RS-232) 1 x Clear CMOS jumper 1 x Buzzer	1 x 24-pin ATX main power connector 1 x 4-pin ATX 12V power connector 1 x CPU fan header 2 x System fan headers 1 x Front panel header 1 x Front audio header 1 x 2W Speaker out header 6 x USB 2.0 headers 2 x COM headers (RS-232 & RI/5V/12V) 1 x LPC 1 x LPT 1 x GPIO (8 bits) & SMBUS header 1 x Clear CMOS jumper 1 x Buzzer
<b>Rear I/O</b>	3 x Audio Jacks (Line in, Line out, Mic in) 1 x COM port (RS-232) 1 x HDMI 1 x DVI-D 1 x VGA 2 x RJ45 LAN ports 4 x USB 3.0	3 x Audio Jacks (Line in, Line out, Mic in) 1 x COM port (RS-232) 1 x HDMI 1 x DVI-D 1 x VGA 2 x RJ45 LAN ports 4 x USB 3.0	3 x Audio Jacks (Line in, Line out, Mic in) 2 x COM ports (RS-232/422/485) 1 x VGA 1 x DVI-D 2 x RJ45 LAN ports 4 x USB 3.0 1 x PS2 KB/MS
<b>TPM</b>	Onboard TPM 2.0 security chip INFINEON SLB9665VQ2.0	1 x TPM header	Onboard TPM 1.2 security chip Infineon SLB9635TT1.2
<b>Operating Temp.</b>	0°C to 60°C	0°C to 60°C	0°C to 60°C
<b>Ordering Information</b>	9MCH31AMNR-SI (Bulk packing)	9MDH11BMNR-SI (Bulk packing)	9MATMH81NR-SI (Bulk packing) 9MATMH81MR-SI (Box packing)

## Micro-ATX Series



Micro-ATX Series/ Mini-ITX Series

Model Name	uATX-X570	uATX-RYZEN
<b>CPU</b>	Supports 3rd Generation AMD Ryzen™ processors/ 2nd Generation AMD Ryzen™ processors/ 2nd Generation AMD Ryzen™ with Radeon™ Vega Graphics processors	Supports AMD 3rd Gen/ 2nd Gen/ 1st Gen Ryzen™ CPU/APU AM4 μPGA (Matisse/ Picasso/ Raven2/ Pinnacle/ Raven/ Summit Ridge), TDP under 95W
<b>Socket</b>	—	Socket AM4
<b>Chipset</b>	AMD® X570	AMD® B450
<b>Memory</b>	4 x DDR4 DIMM sockets, Max. Capacity 128 GB, Support Dual Channel DDR4 3200MHz	4 x DDR4 DIMM sockets, Max. Capacity 64 GB, Support Dual Channel DDR4 2666/2400/2133 MHz
<b>Ethernet</b>	2 x GbE LAN ports (Realtek® RTL8111HS)	2 x GbE LAN ports (Realtek® RTL8111HS)
<b>Graphic</b>	1 x HDMI 2.0 1 x Display Port (DP V1.2) 1 x VGA 3 independent display outputs	Integrated Graphics Processor - Radeon™ Vega 11/ 8/ 3/ Graphics 1 x HDMI 1.4 1 x Display Port 1 x VGA 3 independent display outputs
<b>Audio</b>	Realtek® ALC888S	Realtek® ALC269
<b>Storage</b>	8 x SATA 6Gb/s ports (RAID 0/1/10)	4 x SATA 6Gb/s ports (RAID 0/1/10)
<b>Expansion Slots</b>	1 x PCIe x16 (Gen4 x16) - depends on CPU 1 x PCIe x4 (Gen4 x2) - depends on CPU 2 x PCIe x1 (Gen4 x1) - depends on CPU 1 x 2280/2242 M.2 M-Key (PCIe x4) 1 x 2280/2242 M.2 M-Key (PCIe x4, SATA 6Gb/s)	1 x PCIe x16 (Gen3 x16) 1 x PCIe x4 (Gen2 x2) 2 x PCIe x1 (Gen2 x1) 1 x 2280/2260/2242 M.2 M-Key (PCIe x4, SATA 6Gb/s)
<b>Internal I/O</b>	1 x 24-pin ATX main power connector 1 x 8-pin ATX power connector 1 x CPU fan header 2 x System fan headers 1 x Front panel header 1 x Front audio header 4 x USB 2.0 headers 2 x USB 3.0 headers 3 x COM headers (RS-232) 1 x BMC connector 1 x SPI connector 1 x Clear CMOS jumper 1 x Buzzer	1 x 24-pin ATX main power connector 1 x 4-pin ATX 12V power connector 1 x CPU fan header 2 x System fan headers 1 x Front panel header 1 x Front audio header 1 x 2W Speaker out header 4 x USB 2.0 headers 2 x USB 3.0 headers 5 x COM headers (RS-232) 1 x PS/2 Keyboard/ Mouse Connector 1 x GPIO (8 bits) & SMBUS header 1 x Clear CMOS jumper 1 x Buzzer
<b>Rear I/O</b>	3 x Audio Jacks (Line in, Line out, Mic in) 1 x COM (RS-232/422/485) 1 x HDMI 1 x Display Port 1 x VGA 2 x RJ45 LAN ports 4 x USB 3.0 1 x USB 3.1 Gen2 1 x USB 3.1 Gen2 (Type C)	3 x Audio Jacks (Line in, Line out, Mic in) 1 x COM port (RS-232/422/485 & RI/5V/12V) 1 x HDMI 1 x Display Port 1 x VGA 2 x RJ45 LAN ports 4 x USB 3.0 1 x USB 3.1 Gen2 1 x USB 3.1 Gen2 Type C
<b>TPM</b>	Onboard TPM 2.0 security chip INFINEON SLB9670VQ2.0 (Optional)	1 x TPM header
<b>Operating Temp.</b>	0°C to 60°C	0°C to 60°C
<b>Ordering Information</b>	—	9MZRYZBMNR-SI (Bulk packing)

## Mini-ITX Series

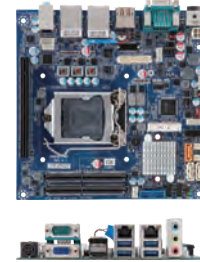
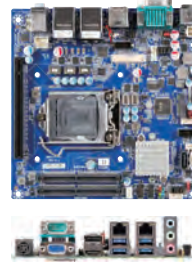

Model Name	mITX-Q370A	mITX-H310A	mITX-Q170A
<b>CPU</b>	Support for 8th/9th Generation Intel® Core™ i7/i5/i3, Pentium® & Celeron® processors, TDP under 65W	Support for 8th/9th Generation Intel® Core™ i7/i5/i3, Pentium® & Celeron® processors, TDP under 65W	Supports for 6/7th Generation Intel® Core™ i7/i5/i3, Pentium® & Celeron® processors, TDP under 65W
<b>Socket</b>	LGA 1151	LGA 1151	LGA 1151
<b>Chipset</b>	Intel® Q370 Chipset	Intel® H310 Chipset	Intel® Q170 Chipset
<b>Memory</b>	2 x DDR4 SO-DIMM sockets, Max. Capacity 32 GB, Support Dual Channel DDR4 2666/2400 MHz	2 x DDR4 SO-DIMM sockets, Max. Capacity 32 GB, Support Dual Channel DDR4 2666/2400 MHz	2 x DDR4 SO-DIMM sockets, Max. Capacity 32 GB, Support Dual Channel DDR4 2400/2133 MHz
<b>Ethernet</b>	2 x GbE LAN ports (Intel® I219LM and Intel® I211AT)	2 x GbE LAN ports (Intel® I219V and Intel® I211AT)	2 x GbE LAN ports (Intel® I219LM and Intel® I211AT)
<b>Graphic</b>	Integrated Graphics Processor - depends on CPU: 1 x HDMI 1.4, 1 x Display Port 1 x VGA, 1 x eDP 3 independent display outputs	Integrated Graphics Processor - depends on CPU: 1 x HDMI 1.4, 1 x Display Port 1 x VGA, 1 x LVDS or eDP 2 independent display outputs	Integrated Graphics Processor - depends on CPU: 1 x HDMI 1.4, 1 x Display Port 1 x LVDS or eDP 3 independent display outputs
<b>Audio</b>	Realtek® ALC269	Realtek® ALC269	Realtek® ALC269
<b>Storage</b>	3 x SATA 6Gb/s ports (RAID 0/1/5/10)	2 x SATA 6Gb/s ports	3(2) x SATA 6Gb/s ports (RAID 0/1/5/10) (incl. 1 x SATA supports SATA DOM)
<b>Expansion Slots</b>	1 x PCIe x16 (Gen3 x16) 1 x 2280/2242 M.2 M-Key (PCIe x4, SATA 6Gb/s, Optane memory) 1 x 2230 M.2 E-Key	1 x PCIe x16 (Gen3 x16) 1 x 2280/2242 M.2 M-Key (SATA 6Gb/s) 1 x 2230 M.2 E-Key	1 x PCIe x16 (Gen3 x16) 1 x 2280/2242 M.2 M-Key (PCIe x4, SATA 6Gb/s) 1 x Full-size Mini PCIe/mSATA
<b>Internal I/O</b>	1 x 4-pin ATX main power connector 2 x SATA power connectors 1 x CPU fan header 1 x System fan header 1 x Front panel header 1 x Front panel audio header 1 x 2W Speaker out header 4 x USB 2.0 headers 2 x USB 3.0 headers 1 x COM header (RS-232) 1 x GPIO (8 bits) & SMBUS header 1 x Backlight Control header 1 x Clear CMOS jumper 1 x Buzzer	1 x 4-pin ATX main power connector 1 x SATA power connector 1 x CPU fan header 1 x System fan header 1 x Front panel header 1 x Front panel audio header 1 x 2W Speaker out header 4 x USB 2.0 headers 2 x COM headers (RS-232) 1 x COM header (RS-232/422/485 & RI/5V/12V) 1 x GPIO (8 bits) & SMBUS header 1 x Backlight Control header 1 x Clear CMOS jumper 1 x Buzzer	1 x 4-pin ATX main power connector 2 x SATA power connectors 1 x CPU fan header 1 x System fan header 1 x Front panel header 1 x Front panel audio header 1 x 2W Speaker out header 4 x USB 2.0 headers 2 x USB 3.0 headers 1 x COM header (RS-232/422/485 & RI/5V/12V) 1 x GPIO (8 bits) & SMBUS header 1 x Backlight Control header 1 x Clear CMOS jumper 1 x Buzzer
<b>Rear I/O</b>	3 x Audio Jacks (Line in, Line out, Mic in) 1 x COM port (RS-232/422/485 & RI/5V/12V) 1 x HDMI 1 x Display Port 1 x VGA 2 x RJ45 LAN ports 3 x USB 3.0 1 x USB 3.1 Gen2 1 x DC Jack (+12V/+19V/+24VDC)	3 x Audio Jacks (Line in, Line out, Mic in) 1 x COM port (RS-232/422/485 & RI/5V/12V) 1 x HDMI 1 x Display Port 1 x VGA 2 x RJ45 LAN ports 4 x USB 3.0 1 x DC Jack (+12V/+19V/+24VDC)	x Audio Jacks (Line in, Line out, Mic in) 1 x COM port (RS-232/422/485 & RI/5V/12V) 1 x HDMI 1 x Display Port 1 x VGA 2 x RJ45 LAN ports 4 x USB 3.0 1 x DC Jack (+12V/+19V/+24VDC)
<b>TPM</b>	1 x TPM header	1 x TPM header	1 x TPM header
<b>Operating Temp.</b>	0°C to 60°C	0°C to 60°C	0°C to 60°C
<b>Ordering Information</b>	9MCQ37AINR-SI (Bulk packing)	9MH310AINR-SI (Bulk packing) 9MH310AIMR-SI (Box packing)	9MDQ17BIMR-SI (Box packing)

## Mini-ITX Series



Mini-ITX Series

Model Name	mITX-H110A	mITX-H110B
<b>CPU</b>	Supports for 6/7th Generation Intel® Core™ i7/i5/i3, Pentium® & Celeron® processors, TDP under 65W	Supports for 6/7th Generation Intel® Core™ i7/i5/i3, Pentium® & Celeron® processors, TDP under 65W
<b>Socket</b>	LGA 1151	LGA 1151
<b>Chipset</b>	Intel® H110 Chipset	Intel® H110 Chipset
<b>Memory</b>	2 x DDR4 SO-DIMM sockets, Max. Capacity 32 GB, Support Dual Channel DDR4 2400/2133 MHz	2 x DDR4 SO-DIMM sockets, Max. Capacity 32 GB, Support Dual Channel DDR4 2400/2133 MHz
<b>Ethernet</b>	2 x GbE LAN ports (Intel® I219V and Intel® I211AT)	6 x GbE LAN ports (1 x Intel® I219V and 5 x Intel® I211AT)
<b>Graphic</b>	Integrated Graphics Processor - depends on CPU: 1 x HDMI 1.4 1 x Display Port 1 x VGA 1 x LVDS or eDP 2 independent display outputs	Integrated Graphics Processor - depends on CPU: 1 x HDMI 1.4 1 x VGA 2 independent display outputs
<b>Audio</b>	Realtek® ALC269	Realtek® ALC269
<b>Storage</b>	3 x SATA 6Gb/s ports (incl. 1 x SATA supports SATA DOM)	2 x SATA 6Gb/s ports
<b>Expansion Slots</b>	1 x PCIe x16 (Gen3 x16) 1 x 2280/2242 M.2 M-Key (SATA 6Gb/s) 1 x Full-size Mini PCIe	1 x PCIe x16 (Gen3 x16) 1 x 2280/2242 M.2 M-Key (SATA 6Gb/s) 1 x Full-size mSATA
<b>Internal I/O</b>	1 x 4-pin ATX main power connector 2 x SATA power connectors 1 x CPU fan header 1 x System fan header 1 x Front panel header 1 x Front panel audio header 1 x 2W Speaker out header 3 x USB 2.0 headers 2 x USB 3.0 headers 1 x COM header (RS-232/422/485 & RI/5V/12V) 1 x GPIO (8 bits) & SMBUS header 1 x Backlight Control header 1 x Clear CMOS jumper 1 x Buzzer	1 x 4-pin ATX main power connector 2 x SATA power connectors 1 x CPU fan header 1 x System fan header 1 x Front panel header 1 x Front panel audio header 1 x 2W Speaker out header 6 x USB 2.0 headers 2 x COM headers (RS-232/422/485 & RI/5V/12V) 1 x GPIO (8 bits) & SMBUS header 1 x Clear CMOS jumper 1 x Buzzer
<b>Rear I/O</b>	3 x Audio Jacks (Line in, Line out, Mic in) 1 x COM port (RS-232/422/485 & RI/5V/12V) 1 x HDMI 1 x Display Port 1 x VGA 2 x RJ45 LAN ports 2 x USB 2.0 2 x USB 3.0 1 x DC Jack (+12/+19/+24VDC)	3 x Audio Jacks (Line in, Line out, Mic in) 1 x HDMI 1 x VGA 6 x RJ45 LAN ports 4 x USB 3.0 1 x DC Jack (+12V/+19V/+24VDC)
<b>TPM</b>	1 x TPM header	1 x TPM header
<b>Operating Temp.</b>	0°C to 60°C	0°C to 60°C
<b>Ordering Information</b>	9MDH11LINR-SI (Bulk packing) 9MDH11LIMR-SI (Box packing)	9MH110A1NR-SI (Bulk packing) 9MH110A1MR-SI (Box packing)

## Mini-ITX Series



Model Name	mITX-4105A	mITX-4205A
<b>CPU</b>	Intel® Celeron® J4105 Processor, 14nm, 4 cores, 4 threads, up to 2.5 GHz, TDP 10W, fan-less design	Intel® Pentium® Processor J4205, 14nm, 4 cores, 4 threads, up to 2.6 GHz, TDP 10W, fan-less design
<b>Socket</b>	FCBGA1090	FCBGA1296
<b>Chipset</b>	—	—
<b>Memory</b>	2 x DDR4 SO-DIMM sockets, Max. Capacity 8 GB, Support Dual Channel DDR4 2400 MHz	2 x DDR3L SO-DIMM sockets, Max. Capacity 8 GB, Support Dual Channel DDR3L 1866 MHz
<b>Ethernet</b>	2 x GbE LAN ports (Realtek® RTL8111HS)	2 x GbE LAN ports (Realtek® RTL8111HS)
<b>Graphic</b>	Integrated Graphics Processor - Intel® UHD Graphics 600: 1 x HDMI 2.0 1 x VGA 1 x LVDS or eDP 3 independent display outputs	Integrated Graphics Processor - Intel® HD Graphics 505: 1 x HDMI 1.4 1 x VGA 1 x LVDS or eDP 3 independent display outputs
<b>Audio</b>	Realtek® ALC269	Realtek ALC269
<b>Storage</b>	5 x SATA 6Gb/s ports (4 x from Marvell 88SE9230, support RAID 0/1/10) (1 x from J4105 supports SATA DOM)	5 x SATA 6Gb/s ports (4 x from Marvell 88SE9230, support RAID 0/1/10) (1 x from J4205 supports SATA DOM)
<b>Expansion Slots</b>	1 x PCIe x4 (Gen2 x2) 1 x 2280/2260/2242 M.2 M-Key (SATA 6Gb/s) 1 x 2230 M.2 E-Key (CNVi cards only)	1 x PCIe x1 (Gen2 x1) 1 x Full-size mSATA
<b>Internal I/O</b>	1 x 4-pin ATX main power connector 3 x SATA power connectors 1 x CPU fan header 1 x System fan header 1 x Front panel header 1 x Front panel audio header 1 x 2W Speaker out header 2 x USB 2.0 headers 2 x USB 3.0 headers 4 x COM headers (RS-232) 1 x GPIO (8 bits) & SMBUS header 1 x Case open header 1 x AT/ATX mode jumper 1 x Backlight Control header 1 x RAID LED header 2 x LAN LED headers 1 x Clear CMOS jumper 1 x Buzzer	1 x 4-pin ATX power connector 5 x SATA power connectors 1 x CPU fan header 1 x System fan header 1 x Front panel header 1 x Front panel audio header 1 x 2W Speaker out header 2 x USB 2.0 headers 2 x USB 3.0 headers 4 x COM headers (RS-232) 1 x GPIO (8 bits) & SMBUS header 1 x Case open header 1 x PS/2 KB/MS Connector 1 x Backlight Control header 1 x RAID LED header 2 x LAN LED headers 1 x Clear CMOS jumper 1 x Buzzer
<b>Rear I/O</b>	3 x Audio Jacks (Line in, Line out, Mic in) 2 x COM ports (RS-232/422/485 & RI/5V/12V) 1 x HDMI 2.0 1 x VGA 2 x RJ45 LAN ports 2 x USB 2.0 2 x USB 3.0 1 x DC Jack (+12VDC)	3 x Audio Jacks (Line in, Line out, Mic in) 2 x COM ports (RS-232/422/485 & RI/5V/12V) 1 x HDMI 1 x VGA 2 x RJ45 LAN ports 2 x USB 2.0 2 x USB 3.0 1 x DC Jack (+12VDC)
<b>TPM</b>	1 x TPM header	1 x TPM header
<b>Operating Temp.</b>	0°C to 60°C	0°C to 60°C
<b>Ordering Information</b>	9MZGLKAINR-SI (Bulk packing)	Fanless version: 9MZAPLAINR-SI (Bulk packing)

## Mini-ITX Series



Mini-ITX Series/Thin-Mini-ITX Series

Model Name	mITX-1900A	mITX-1605A
<b>CPU</b>	Intel® Celeron® Processor J1900, 22nm, 4 cores, 4 threads, up to 2.42 GHz, TDP 10W	AMD® RYZEN™ Embedded V1605B, 14nm, 4 cores, 8 threads, 2.0 GHz, up to 3.6 GHz, TDP 25W
<b>Socket</b>	FCBGA1170	FP5 BGA
<b>Chipset</b>	—	—
<b>Memory</b>	2 x DDR3L SO-DIMM sockets, Max. Capacity 8 GB, Support Dual Channel DDR3L 1333MHz	2 x DDR4 SO-DIMM sockets, Max. Capacity 32 GB, Support Dual Channel DDR4 2400 MHz
<b>Ethernet</b>	2 x GbE LAN ports (Realtek® RTL8111G)	2 x GbE LAN ports (Realtek® RTL8111HS)
<b>Graphic</b>	Integrated Graphics Processor - Intel® HD Graphics: 1 x HDMI 1.4 1 x VGA 1 x LVDS 2 independent display outputs	Integrated Graphics Processor - AMD Radeon™ Vega 8 Graphics: 4 x Display Port 1 x LVDS (Share from DP) 4 independent display outputs
<b>Audio</b>	Realtek® ALC269	Realtek® ALC269
<b>Storage</b>	1 x SATA 3Gb/s port (incl. 1 x SATA supports SATA DOM)	1 x SATA 6Gb/s port
<b>Expansion Slots</b>	1 x PCI 1 x Full-size Mini PCIe 1 x Full-size mSATA	1 x PCIe x16 (Gen3 x8) 1 x 2280 M.2 M-Key (SATA 6Gb/s) 1 x 2230 M.2 E-Key 1 x Full-size Mini PCIe with SIM slot
<b>Internal I/O</b>	1 x 4-pin ATX power connector 1 x SATA power header 1 x CPU fan header 1 x System fan header 1 x Front panel header 1 x Front audio header 1 x 2W Speaker out header 2 x USB 2.0 headers 1 x COM header (RS-232/422/485) 3 x COM headers (RS-232) 1 x COM header (RS-232 & RI/5V/12V) 1 x GPIO (8 bits) & SMBUS header 1 x PS/2 KB/MS Connector 1 x AT/ATX mode jumper 1 x Backlight control header 1 x Clear CMOS jumper 1 x Buzzer	1 x 4-pin ATX power connector 1 x SATA power connector 1 x CPU fan header 1 x System fan header 1 x Front panel header 1 x Front panel audio header 1 x 2W Speaker out header 6 x USB 2.0 headers 2 x COM headers (RS-232) 1 x GPIO (8 bits) & SMBUS header 1 x Backlight Control header 1 x LVDS/ DP Jumper 1 x AT/ATX mode jumper 1 x Clear CMOS jumper
<b>Rear I/O</b>	3 x Audio Jacks (Line in, Line out, Mic in) 1 x COM port (RS-232) 1 x HDMI 1 x VGA 2 x RJ45 LAN ports 4 x USB 2.0 1 x USB 3.0 1 x DC Jack (+12VDC)	3 x Audio Jacks (Line in, Line out, Mic in) 2 x COM ports (RS-232/422/485 & RI/5V/12V) 4 x Display Port 2 x RJ45 LAN ports 4 x USB 3.0 1 x DC Jack (+12V~24VDC)
<b>TPM</b>	1 x TPM header	1 x TPM header
<b>Operating Temp.</b>	0°C to 60°C	0°C to 60°C
<b>Ordering Information</b>	Fan version: 9MVBAYAINR-SI (Bulk packing) Fanless version: 9MVBAYAINR-00 (Bulk packing)	Fan version: 9MRZNVIMIR-SI (Box packing)



## Thin Mini-ITX Series



Model Name	iTXL-Q370A	iTXL-Q170A	iTXL-H110C
<b>CPU</b>	Support for 8th/9th Generation Intel® Core™ i7/i5/i3, Pentium® & Celeron® processors, TDP under 65W	Supports for 6/7th Generation Intel® Core™ i7/i5/i3, Pentium® & Celeron® processors, TDP under 65W	Supports for 6/7th Generation Intel® Core™ i7/i5/i3, Pentium® & Celeron® processors, TDP under 65W
<b>Socket</b>	LGA 1151	LGA 1151	LGA 1151
<b>Chipset</b>	Intel® Q370 Chipset	Intel® Q170 Chipset	Intel® H110 Chipset
<b>Memory</b>	2 x DDR4 SO-DIMM sockets, Max. Capacity 32 GB, Support Dual Channel DDR4 2666/2400 MHz	2 x DDR4 SO-DIMM sockets, Max. Capacity 32 GB, Support Dual Channel DDR4 2400/2133 MHz	2 x DDR4 SO-DIMM sockets, Max. Capacity 32 GB, Support Dual Channel DDR4 2400/2133 MHz
<b>Ethernet</b>	1 x GbE LAN port (Intel® I219LM)	1 x GbE LAN port (Intel® I219LM)	1 x GbE LAN port (Realtek® RTL8111HS)
<b>Graphic</b>	Integrated Graphics Processor - depends on CPU: 1 x HDMI 2.0 1 x Display Port 1 x LVDS 3 independent display outputs	Integrated Graphics Processor - depends on CPU: 1 x HDMI 1.4 1 x Display Port 1 x LVDS 3 independent display outputs	Integrated Graphics Processor - depends on CPU: 1 x HDMI1.4 1 x Display Port 1 x LVDS 2 independent display outputs
<b>Audio</b>	Realtek® ALC887 + ALC105 Amplifier	Realtek® ALC887 + ALC105 Amplifier	Realtek® ALC887 + ALC105 Amplifier
<b>Storage</b>	4 x SATA 6Gb/s ports (RAID 0/1/5/10)	4 x SATA 6Gb/s ports (RAID 0/1/5/10)	2 x SATA 6Gb/s ports
<b>Expansion Slots</b>	1 x PCIe x4 (Gen3 x4) 1 x 2280/2260 M.2 M-Key (PCIe x4, SATA6Gb/s, Optane memory) 1 x 2230 M.2 E-Key	1 x PCIe x4 (Gen3 x4) 1 x 2280/2260 M.2 M-Key (PCIe x4, SATA6Gb/s) 1 x 2230 M.2 E-Key	1 x 2280/2260 M.2 M-Key (PCIe x2, SATA 6Gb/s) 1 x 2230 M.2 E-Key
<b>Internal I/O</b>	1 x 2-pin ATX main power connector 1 x SATA Power connector 1 x CPU fan header 1 x System fan header 1 x Front panel header 1 x Front panel audio header 1 x 3W Speaker out header 1 x DMIC header 5 x USB 2.0 headers 2 x USB 3.0 headers 1 x COM header (RS-232) 1 x FPD (For LVDS 19V) 1 x FPD_SW 1x3 (For Panel Power SW) 1 x LCD_VCC Pin header 1 x Backlight Control header	1 x 2-pin ATX main power connector 1 x SATA Power connector 1 x CPU fan header 1 x System fan header 1 x Front panel header 1 x Front panel audio header 1 x 3W Speaker out header 1 x DMIC header 5 x USB 2.0 headers 2 x USB 3.0 headers 1 x COM header (RS-232) 1 x FPD (For LVDS 19V) 1 x FPD_SW 1x3 (For Panel Power SW) 1 x LCD_VCC Pin header 1 x Backlight Control header 1 x NFC connector	1 x 2-pin ATX main power connector 1 x SATA Power connector 1 x CPU fan header 1 x System fan header 1 x Front panel header 1 x Front panel audio header 1 x 3W Speaker out header 1 x DMIC header 5 x USB 2.0 headers 1 x COM header (RS-232) 1 x FPD (For LVDS 19V) 1 x FPD_SW 1x3 (For Panel Power SW) 1 x LCD_VCC Pin header 1 x Backlight Control header
<b>Rear I/O</b>	2 x Audio Jacks (Line out, Mic in) 1 x HDMI 1 x Display Port 1 x RJ45 LAN port 3 x USB 3.0 1 x USB 3.0 Type C 1 x DC Jack (+12V/+19VDC)	2 x Audio Jacks (Line out, Mic in) 1 x HDMI 1 x Display Port 1 x RJ45 LAN port 4 x USB 3.0 1 x DC Jack (+12V/+19VDC)	2 x Audio Jacks (Line out, Mic in) 1 x HDMI 1 x Display Port 1 x RJ45 LAN port 4 x USB 3.0 1 x DC Jack (+12V/+19VDC)
<b>TPM</b>	1 x TPM header	Onboard TPM 2.0 security chip INFINEON SLB9665VQ2.0	1 x TPM header
<b>Operating Temp.</b>	0°C to 60°C	0°C to 60°C	0°C to 60°C
<b>Ordering Information</b>	9MQ37ATMR-SI (Box packing)	9MDQ17AINR-SI (Bulk packing)	9MDH11KINR-SI (Bulk packing)

## Thin Mini-ITX Series

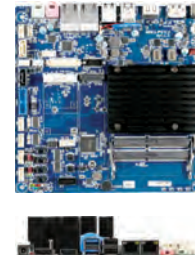

Thin Mini-ITX Series

Model Name	iTXL-6100B	iTXL-3955A
<b>CPU</b>	Intel® Core™ i3-6100U Processor, 14nm, 2 cores, 4 threads, 2.3 GHz, TDP 15W	Intel® Celeron® Processor 3955U, 14nm, 2 cores, 4 threads, 2.0 GHz, TDP 15W
<b>Socket</b>	FCBGA1356	FCBGA1356
<b>Chipset</b>	—	—
<b>Memory</b>	2 x DDR4 SO-DIMM sockets, Max. Capacity 32 GB, Support Dual Channel DDR4 2133 MHz	2 x DDR4 SO-DIMM sockets, Max. Capacity 32 GB, Support Dual Channel DDR4 2133 MHz
<b>Ethernet</b>	2 x GbE LAN ports (Intel® I219V and Intel® I211AT)	2 x GbE LAN ports (Intel® I219V and Intel® I211AT)
<b>Graphic</b>	Integrated Graphics Processor - Intel® HD Graphics 520: 1 x HDMI 1.4, 1 x Display Port, 1 x LVDS or eDP, 3 independent display outputs	Integrated Graphics Processor - Intel® HD Graphics 510: 1 x HDMI 1.4, 1 x Display Port, 1 x LVDS or eDP, 3 independent display outputs
<b>Audio</b>	Realtek® ALC269	Realtek® ALC269
<b>Storage</b>	2 x SATA 6Gb/s ports (RAID 0/1/5) (incl. 1 x SATA supports SATA DOM)	2 x SATA 6Gb/s ports (incl. 1 x SATA supports SATA DOM)
<b>Expansion Slots</b>	1 x 2280/2242 M.2 M-Key (PCIe x2, SATA 6Gb/s) 1 x Full-size Mini PCIe	1 x 2280/2242 M.2 M-Key (PCIe x2, SATA 6Gb/s) 1 x Full-size Mini PCIe
<b>Internal I/O</b>	1 x 4-pin ATX main power connector 2 x SATA Power connectors 1 x CPU fan header 1 x System fan header 1 x Front panel header 1 x Front panel audio header 1 x 2W Speaker out header 2 x USB 2.0 headers 2 x USB 3.0 headers 2 x COM headers (RS-232) 2 x COM headers (RS-232/422/485 & RI/5V/12V) 1 x LCD_VCC Pin header 1 x Backlight Control header 1 x GPIO (8 bits) & SMBUS header 1 x Buzzer	1 x 4-pin ATX main power connector 2 x SATA Power connectors 1 x CPU fan header 1 x System fan header 1 x Front panel header 1 x Front panel audio header 1 x 2W Speaker out header 2 x USB 3.0 headers 2 x COM headers (RS-232) 2 x COM headers (RS-232/422/485 & RI/5V/12V) 1 x LCD_VCC Pin header 1 x Backlight Control header 1 x GPIO (8 bits) & SMBUS header 1 x Buzzer
<b>Rear I/O</b>	2 x Audio Jacks (Line out, Mic in) 1 x HDMI, 1 x Display Port 2 x RJ45 LAN ports 2 x USB 2.0, 2 x USB 3.0 1 x DC Jack (+12VDC)	2 x Audio Jacks (Line out, Mic in) 1 x HDMI, 1 x Display Port 2 x RJ45 LAN ports 2 x USB 2.0, 2 x USB 3.0 1 x DC Jack (+12VDC)
<b>TPM</b>	1 x TPM header	1 x TPM header
<b>Operating Temp.</b>	0°C to 60°C	0°C to 60°C
<b>Ordering Information</b>	9MKLP3CIMR-SI (Box packing)	9MKLPCCIMR-SI (Box packing)

## Thin Mini-ITX Series



Model Name	iTXL-3350A	iTXL-1900A
<b>CPU</b>	Intel® Celeron® Processor N3350, 14nm, 2 cores, 2 threads, up to 2.4 GHz, TDP 6W	Intel® Celeron® Processor J1900, 22nm, 4 cores, 4 threads, up to 2.42 GHz, TDP 10W
<b>Socket</b>	FCBGA1296	FCBGA1170
<b>Chipset</b>	—	—
<b>Memory</b>	2 x DDR3L SO-DIMM sockets, Max. Capacity 8 GB, Support Dual Channel DDR3L 1866 MHz	2 x DDR3L SO-DIMM sockets, Max. Capacity 8 GB, Support Dual Channel DDR3L 1333 MHz
<b>Ethernet</b>	2 x GbE LAN ports (Realtek® RTL8111HS)	1 x GbE LAN ports (Realtek® RTL8111G)
<b>Graphic</b>	Integrated Graphics Processor - Intel® HD Graphics 500: 1 x HDMI 1.4, 1 x Disply Port, 1 x LVDS or eDP, 3independent display outputs	Integrated Graphics Processor - Intel® HD Graphics: 1 x HDMI 1.4, 1 x VGA, 1 x LVDS, 2 independent display outputs
<b>Audio</b>	Realtek® ALC269	Realtek® ALC887 + ALC105 Amplifier
<b>Storage</b>	2 x SATA 6Gb/s ports (1 x switches with mSATA) (incl. 1 x SATA supports SATA DOM)	1 x SATA 6Gb/s port (switches with mSATA) 2 x SATA 3Gb/s ports eMMC (Optional)
<b>Expansion Slots</b>	1 x Full-size Mini PCIe/mSATA 1 x Half-size Mini PCIe (PCIe Only)	1 x PCIe x4 (Gen2 x1) 1 x mSATA (SATA 6Gb/s) 1 x Half-size Mini PCIe
<b>Internal I/O</b>	1 x 4-pin ATX main power connector 2 x SATA Power connectors 1 x CPU fan header 1 x System fan header, 1 x Front panel header, 1 x Front panel audio header 1 x 2W Speaker out header 1 x USB 2.0 header 2 x USB 3.0 headers 4 x COM headers (RS-232) 2 x COM headers (RS-232/422/485 & RI/5V/12V) 1 x LCD_VCC Pin header 1 x Backlight Control header 1 x PS/2 KB/MS Connector 1 x GPIO (8 bits) & SMBUS header, 1 x Buzzer	1 x 2-pin ATX main power connector 1 x SATA power connector 1 x CPU fan header 1 x System fan header 1 x Front panel header 1 x Front panel audio header 1 x 3W Speaker out header 1 x DMIC header 3 x USB 2.0 headers 1 x COM header (RS-232) 1 x FPD (For LVDS 19V) 1 x FPD_SW 1x3 (For Panel Power SW) 1 x LCD_VCC Pin header 1 x Backlight Control header 1 x LPT header 1 x Micro SD connector
<b>Rear I/O</b>	2 x Audio Jacks (Line out, Mic in) 1 x HDMI, 1 x Display Port 2 x RJ45 LAN ports 2 x USB 2.0, 2 x USB 3.0 1 x DC Jack (+12VDC)	2 x Audio Jacks (Line out, Mic in) 1 x HDMI, 1 x VGA 1 x RJ45 LAN port 2 x USB 2.0, 1 x USB 3.0 1 x DC Jack (+12V/+19VDC)
<b>TPM</b>	1 x TPM header	—
<b>Operating Temp.</b>	0°C to 60°C	0°C to 60°C
<b>Ordering Information</b>	9MZAPLBINR-SI (Bulk packing) 9MZAPLBIMR-SI (Box packing)	9MZBAYAINR-SI (Bulk packing)

## QBiP Series (3.5" SBC)



QBiP Series (3.5" SBC)

Model Name	QBiP-8565A/ QBiP-8265A/ QBiP-8145A	QBiP-7600A/ QBiP-7200A/ QBiP-7100A
<b>CPU</b>	Intel® Core™ i7-8565U Processor, 14nm, 4 cores, 8 threads, up to 4.6 GHz, TDP 15W (QBiP-8565A) Intel® Core™ i5-8265U Processor, 14nm, 4 cores, 8 threads, up to 3.9 GHz, TDP 15W (QBiP-8265A) Intel® Core™ i3-8145UE Processor, 14nm, 2 cores, 4 threads, up to 3.9 GHz, TDP 15W (QBiP-8145A)	Intel® Core™ i7-7600U Processor, 14nm, 2 cores, 4 threads, up to 3.9 GHz, TDP 15W (QBiP-7600A) Intel® Core™ i5-7200U Processor, 14nm, 2 cores, 4 threads, up to 3.1GHz, TDP 15W (QBiP-7200A) Intel® Core™ i3-7100U Processor, 14nm, 2 cores, 4 threads, 2.4 GHz, TDP 15W (QBiP-7100A)
<b>Socket</b>	FCBGA1528	FCBGA1356
<b>Chipset</b>	SoC	SoC
<b>Memory</b>	2 x DDR4 SO-DIMM sockets, Max. Capacity 32 GB, Support Dual Channel DDR4 2400 MHz	2 x DDR4 SO-DIMM sockets, Max. Capacity 32 GB, Support Dual Channel DDR4 2133 MHz
<b>Ethernet</b>	2 x GbE LAN ports (Intel® I219V and Intel® I211AT)	2 x GbE LAN ports (Intel® I219V and Intel® I211AT) (7600A: Intel® I219LM and Intel® I211AT)
<b>Graphic</b>	Integrated Graphics Processor - Intel® UHD Graphics 620: 2 x HDMI 1.4, 1 x LVDS 3 independent display outputs	Integrated Graphics Processor - Intel® HD Graphics 620: 1 x HDMI 2.0, 1 x Display Port, 1 x LVDS 3 independent display outputs
<b>Audio</b>	Realtek® ALC269	Realtek® ALC269
<b>Storage</b>	2 x SATA 6Gb/s ports (RAID 0/1/5)	2 x SATA 6Gb/s ports (RAID 0/1/5)
<b>Expansion Slots</b>	1 x 2280 M.2 M-Key (PCIe x4, SATA 6Gb/s) 1 x 2230 M.2 E-Key 1 x Full-size Mini PCIe with SIM slot	1 x 2280 M.2 M-Key (PCIe x4, SATA 6Gb/s) 1 x 2230 M.2 E-Key 1 x Full-size Mini PCIe with SIM slot
<b>Internal I/O</b>	1 x 4-pin box power connector (+9V~36VDC) (48VDC optional) 2 x SATA power headers 1 x CPU fan header 1 x System fan header 1 x Front panel header 1 x Front panel audio header 1 x 2W Speaker out header 2 x USB 2.0 headers 3 x COM headers (RS-232) 1 x Backlight Control header 1 x AT/ATX mode select jumper 1 x GPIO (8 bits) & SMBUS header	1 x 4-pin box power connector (+9V~36VDC) 2 x SATA power headers 1 x CPU fan header 1 x System fan header 1 x Front panel header 1 x Front panel audio header 1 x 2W Speaker out header 2 x USB 2.0 headers 3 x COM headers (RS-232) 1 x Backlight Control header 1 x AT/ATX mode select jumper 1 x GPIO (8 bits) & SMBUS header
<b>Rear I/O</b>	1 x COM port (RS-232/422/485 & RI/5V/12V), 2 x HDMI, 2 x RJ45 LAN ports, 4 x USB 3.1 Gen2	1 x COM port (RS-232/422/485 & RI/5V/12V), 1 x HDMI, 1 x Display Port, 2 x RJ45 LAN ports, 4 x USB 3.0
<b>TPM</b>	1 x TPM header	1 x TPM header
<b>Operating Temp.</b>	0°C to 60°C	0°C to 60°C
<b>Ordering Information</b>	9MWHLUASMR-SI (Box packing) (QBiP-8565A) 9MWHLUBSMR-SI (Box packing) (QBiP-8265A) 9MWHLUCSMR-SI (Box packing) (QBiP-8145A)	9MFLP7BSMR-SI (Box packing) (QBiP-7600A) 9MFLP5ASNR-SI (Bulk packing) (QBiP-7200A) 9MFLP5ASMR-SI (Box packing) (QBiP-7200A) 9MFLP3ASNR-SI (Bulk packing) (QBiP-7100A) 9MFLP3ASMR-SI (Box packing) (QBiP-7100A)
<b>Heatsink P/N</b>	25ST1-153108-A7R	25ST1-153108-A7R
<b>Fan Module P/N</b>	12SF2-01A073-00R	12SF2-01A073-00R
<b>Heat Spreader P/N</b>	25ST5-8265A0-A8R	25ST5-CKAC00-A8R

## QBiP Series (3.5" SBC)

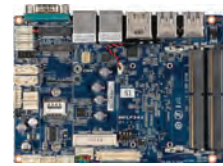
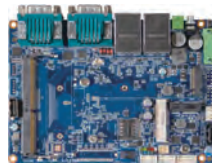

Model Name	QBiP-7100B	QBiP-5005B	QBiP-3965A
<b>CPU</b>	Intel® Core™ i3-7100U Processor , 14nm, 2 cores, 4 threads, 2.4 GHz, TDP 15W	Intel® Pentium® Silver J5005 Processor 14nm, 4 cores, 4 threads, up to 2.8 GHz, TDP 10W	Intel® Celeron® Processor 3965U, 14nm, 2 cores, 2 threads, 2.2 GHz, TDP 15W (QBiP-3965A)
<b>Socket</b>	FCBGA1356	FCBGA1090	FCBGA1356
<b>Chipset</b>	SoC	SoC	SoC
<b>Memory</b>	2 x DDR4 SO-DIMM sockets, Max. Capacity 32 GB, Support Dual Channel DDR4 2133 MHz	1 x DDR4 SO-DIMM socket, Max. Capacity 8 GB, Support Single Channel DDR4 2400 MHz	2 x DDR4 SO-DIMM sockets, Max. Capacity 32 GB, Support Dual Channel DDR4 2133 MHz
<b>Ethernet</b>	2 x GbE LAN ports (Intel® I219V and Intel® I211AT)	2 x GbE LAN ports (Intel® I211AT)	2 x GbE LAN ports (Intel® I219V and Intel® I211AT)
<b>Graphic</b>	Integrated Graphics Processor - Intel® HD Graphics 620: 1 x HDMI 2.0, 1 x Display Port, 1 x LVDS 3 independent display outputs	Integrated Graphics Processor - Intel® UHD Graphics 605: 1 x HDMI 1.4, 1 x VGA, 1 x LVDS 2 independent display output	Integrated Graphics Processor - Intel® HD Graphics 610: 1 x HDMI 2.0, 1 x Display Port, 1 x LVDS 3 independent display outputs
<b>Audio</b>	Realtek® ALC269	Realtek® ALC269	
<b>Storage</b>	2 x SATA 6Gb/s ports (RAID 0/1/5)	1 x SATA 6Gb/s port 1 x eMMC 32GB (Optional)	2 x SATA 6Gb/s ports
<b>Expansion Slots</b>	1 x 2280 M.2 M-Key (PCIe x4, SATA 6Gb/s) 1 x 2230 M.2 E-Key 1 x 3052 M.2 B-Key (PCIe x1, USB 3.0) with SIM slot (Full-size miniPCIe optional)	1 x 2280 M.2 M-Key (SATA 6Gb/s) 1 x 2230 M.2 E-Key 1 x Full-size miniPCIe with SIM slot	1 x 2280 M.2 M-Key (SATA 6Gb/s) 1 x 2230 M.2 E-Key 1 x Full-size Mini PCIe with SIM slot
<b>Internal I/O</b>	1 x 4-pin box power connector(+9V~36VDC) 2 x SATA Power headers 1 x CPU fan header 1 x System fan header 1 x Front panel header 1 x Front panel audio header 1 x 2W Speaker out header 2 x USB 2.0 headers 1 x COM header (RS-232/422/485) 2 x COM headers (RS-232) 1 x Backlight Control header 1 x AT/ATX mode select jumper 1 x GPIO (8 bits) & SMBUS header	1 x 3-pin Terminal Block (+9V~36VDC) 1 x SATA Power headers 1 x System fan header 1 x Front panel header 1 x Front panel audio header 1 x 2W Speaker out header 1 x Vertical USB 2.0 4 x USB 2.0 headers 2 x COM headers (RS-232/422/485) 1 x Backlight Control header 1 x AT/ATX mode select jumper 1 x GPIO (8 bits) & SMBus header	1 x 4-pin box power connector (+9V~36VDC) 2 x SATA power headers 1 x CPU fan header 1 x System fan header 1 x Front panel header 1 x Front panel audio header 1 x 2W Speaker out header 2 x USB 2.0 headers 3 x COM headers (RS-232) 1 x Backlight Control header 1 x AT/ATX mode select jumper 1 x GPIO (8 bits) & SMBUS header
<b>Rear I/O</b>	1 x COM port (RS-232/422/485 & RI/5V/12V) 1 x HDMI 2.0 1 x Display Port 2 x RJ45 LAN ports 4 x USB 3.0	2 x COM Port (RS-232/422/485 & RI/5V/12V) 1 x Headphone Jack 1 x HDMI, 1 x VGA 2 x RJ45 LAN port 2 x USB 3.0 1 x Power Button 1 x Remote Control	1 x COM port (RS-232/422/485 & RI/5V/12V) 1 x HDMI 1 x Display Port, 2 x RJ45 LAN ports 4 x USB 3.0
<b>TPM</b>	1 x TPM header	1 x TPM header	—
<b>Operating Temp.</b>	0°C to 60°C	0°C to 60°C	
<b>Ordering Information</b>	—	9MGMLKBSNR-SI (Bulk packing)	9MFLPCASMR-SI (Box packing) (QBiP-3965A)
<b>Heatsink P/N</b>	25ST1-153108-A7R	25ST1-153109-A7R	25ST1-153108-A7R
<b>Fan Module P/N</b>	12SF2-01A073-00R	—	12SF2-01A073-00R
<b>Heat Spreader P/N</b>	25ST5-CKAC00-A8R	25ST5-CBAB00-A8R	25ST5-CKAC00-A8R

## QBiP Series (3.5" SBC)



Model Name	QBiP-4200A	QBiP-4200B/ QBiP-4200C/ QBiP-3350A
<b>CPU</b>	Intel® Pentium® Processor N4200, 14nm, 4 cores, 4 threads, up to 2.5 GHz, TDP 6W	Intel® Pentium® Processor N4200, 14nm, 4 cores, 4 threads, up to 2.5 GHz, TDP 6W (QBiP-4200B/ 4200C) Intel® Celeron® Processor N3350, 14nm, 2 cores, 2 threads, up to 2.4 GHz, TDP 6W (QBiP-3350A)
<b>Socket</b>	FCBGA1296	FCBGA1296
<b>Chipset</b>	SoC	SoC
<b>Memory</b>	2 x DDR3L SO-DIMM sockets, Max. Capacity 8 GB, Support Dual Channel DDR3L 1866 MHz	2 x DDR3L SO-DIMM sockets, Max. Capacity 8 GB, Support Dual Channel DDR3L 1866 MHz
<b>Ethernet</b>	2 x GbE LAN ports (Intel® I211AT)	2 x GbE LAN ports (Intel® I211AT)
<b>Graphic</b>	Integrated Graphics Processor - Intel® HD Graphics 505: 1 x HDMI 1.4, 1 x VGA, 1 x LVDS or eDP 3 independent display outputs	Integrated Graphics Processor - Intel® HD Graphics 505: 1 x HDMI 1.4, 1 x VGA, 1 x LVDS 3 independent display outputs
<b>Audio</b>	Realtek® ALC269	Realtek® ALC269
<b>Storage</b>	1 x SATA 6Gb/s port 1 x eMMC 32GB	1 x SATA 6Gb/s port 1 x eMMC 32GB (4200B only)
<b>Expansion Slots</b>	1 x 2242 M.2 M-Key (SATA 6Gb/s) 1 x Full-size Mini PCIe with SIM slot	1 x 2242 M.2 M-Key (SATA 6Gb/s) 1 x Full-size Mini PCIe with SIM slot
<b>Internal I/O</b>	1 x 4-pin box power connector (+9V~36VDC) 1 x SATA power header 1 x System fan header 1 x Front panel header 1 x Front panel audio header 1 x 2W Speaker out header 2 x USB 2.0 headers 3 x COM headers (RS-232) 1 x COM header (RS-232/422/485 & RI/5V/12V) 1 x Backlight Control header 1 x AT/ATX mode select jumper 1 x GPIO (8 bits) & SMBUS header 1 x Buzzer header	1 x 4-pin box power connector (+9V~36VDC) 1 x SATA power header 1 x System fan header 1 x Front panel header 1 x Front panel audio header 1 x 2W Speaker out header 4 x USB 2.0 headers 3 x COM headers (RS-232) 1 x COM header (RS-232/422/485 & RI/5V/12V) 1 x Backlight Control header 1 x AT/ATX mode select jumper 1 x GPIO (8 bits) & SMBUS header 1 x Buzzer header
<b>Rear I/O</b>	1 x Headphone Jack 1 x HDMI 1 x VGA 2 x RJ45 LAN ports 2 x USB 3.0	1 x Headphone Jack 1 x HDMI 1 x VGA 2 x RJ45 LAN ports 2 x USB 3.0
<b>TPM</b>	1 x TPM header	1 x TPM header
<b>Operating Temp.</b>	0°C to 60°C	0°C to 60°C
<b>Ordering Information</b>	9MZAPLASNR-SI (Bulk packing) 9MZAPLASMR-SI (Box packing)	9MZAPLCSNR-SI (Bulk packing) (QBiP-4200B) 9MZAPLCSMR-SI (Box packing) (QBiP-4200B) 9MZAPLDSMR-SI (Box packing) (QBiP-4200C) 9MZAPLESMR-SI (Box packing) (QBiP-3350A)
<b>Heatsink P/N</b>	25ST1-153109-A7R	25ST1-153109-A7R
<b>Fan Module P/N</b>	—	—
<b>Heat Spreader P/N</b>	25ST5-CBAB00-A8R	25ST5-CBAB00-A8R

## QBiP Series (3.5" SBC)

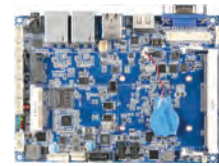

Model Name	QBiP-E3940A	QBiP-1900A
<b>CPU</b>	Intel® Atom® x5-E3940 Processor, 14nm, 4 cores, 4 threads, up to 1.8 GHz, TDP 9.5W	Intel® Celeron® Processor J1900, 22nm, 4 cores, 4 threads, up to 2.42GHz, TDP 10W
<b>Socket</b>	FCBGA1296	FCBGA1170
<b>Chipset</b>	SoC	SoC
<b>Memory</b>	2 x DDR3L SO-DIMM sockets, Max. Capacity 8 GB, Support Dual Channel DDR3L 1866 MHz	1 x DDR3L SO-DIMM socket, Max. Capacity 8 GB, Support Single Channel DDR3L 1333 MHz
<b>Ethernet</b>	2 x GbE LAN ports (Intel® I211AT)	2 x GbE LAN ports (Intel® I211AT)
<b>Graphic</b>	Integrated Graphics Processor - Intel® HD Graphics 500: 1 x HDMI 1.4, 1 x VGA, 1 x LVDS 3 independent display outputs	Integrated Graphics Processor - Intel® HD Graphics: 1 x HDMI 1.4, 1 x VGA, 1 x LVDS 2 independent display outputs
<b>Audio</b>	Realtek® ALC269	Realtek® ALC269
<b>Storage</b>	1 x SATA 6Gb/s port	1 x SATA 3Gb/s port
<b>Expansion Slots</b>	1 x 2242 M.2 M-Key (SATA 6Gb/s) 1 x Full-size Mini PCIe with SIM slot	1 x 2280 M.2 M-Key (SATA 3Gb/s) 1 x Full-size Mini PCIe with SIM slot
<b>Internal I/O</b>	1 x 4-pin box power connector (+9V~36VDC) 1 x SATA power header 1 x System fan header 1 x Front panel header 1 x Front panel audio header 1 x 2W Speaker out header 4 x USB 2.0 headers 3 x COM headers (RS-232) 1 x COM header (RS-232/422/485 & RI/5V/12V) 1 x Backlight Control header 1 x AT/ATX mode select jumper 1 x GPIO (8 bits) & SMBUS header 1 x Buzzer header	1 x 4-pin box power connector (+9V~36VDC) (+48VDC optional) 1 x SATA power header 1 x System fan header 1 x Front panel header 1 x Front panel audio header 1 x 2W Speaker out header 4 x USB 2.0 headers 3 x COM headers (RS-232) 1 x COM header (RS-232/422/485 & RI/5V/12V) 1 x Backlight Control header 1 x AT/ATX mode select jumper 1 x GPIO (8 bits) & SMBUS header 1 x Buzzer header
<b>Rear I/O</b>	1 x Headphone Jack 1 x HDMI 1 x VGA 2 x RJ45 LAN ports 2 x USB 3.0	1 x Headphone Jack 1 x HDMI 1 x VGA 2 x RJ45 LAN ports 1 x USB 2.0 1 x USB 3.0
<b>TPM</b>	1 x TPM header	1 x TPM header
<b>Operating Temp.</b>	0°C to 60°C	0°C to 60°C
<b>Ordering Information</b>	9MAPLKASMR-SI (Box packing)	9MBAYTASNR-SI (Bulk packing) 9MBAYTASMR-SI (Box packing)
<b>Heatsink P/N</b>	25ST1-113103-A7R	25ST1-153107-A7R
<b>Fan Module P/N</b>	—	—
<b>Heat Spreader P/N</b>	—	25ST5-CBAB00-A8R

## QBiP Series (3.5" SBC)



QBiP Series (3.5" SBC) / QBiP Wide Temperature Series

Model Name	QBiP-1605A	QBiP-1606A
<b>CPU</b>	AMD® RYZEN™ Embedded V1605B, 14nm, 4 cores, 8 threads, 2.0 GHz, up to 3.6 GHz, TDP 25W	AMD® RYZEN™ Embedded R1606G, 14nm, 2 cores, 4 threads, 2.6 GHz, up to 3.5 GHz, TDP 25W
<b>Socket</b>	FP5 type 1	FP5 type 1
<b>Chipset</b>	SoC	SoC
<b>Memory</b>	2 x DDR4 SO-DIMM sockets, Max. Capacity 32 GB, Support Dual Channel DDR4 2400 MHz	2 x DDR4 SO-DIMM sockets, Max. Capacity 32 GB, Support Dual Channel DDR4 2400 MHz
<b>Ethernet</b>	2 x GbE LAN ports (Realtek® RTL8111HS)	2 x GbE LAN ports (Realtek® RTL8111HS)
<b>Graphic</b>	Integrated Graphics Processor - AMD® Radeon™ Vega 8 Graphics: 4 x HDMI 2.0, 1 x eDP (share from HDMI) 4 independent display outputs	Integrated Graphics Processor - AMD® Radeon™ Vega 3 Graphics: 3 x HDMI 2.0, 1 x eDP (share from HDMI) 3 independent display outputs
<b>Audio</b>	Realtek® ALC269	Realtek® ALC269
<b>Storage</b>	1 x SATA 6Gb/s port	1 x SATA 6Gb/s port
<b>Expansion Slots</b>	1 x 2280 M.2 M-Key (PCIe x4, SATA 6Gb/s) 1 x 2230 M.2 E-Key 1 x Full-size Mini PCIe with SIM slot	1 x 2280 M.2 M-Key (PCIe x4, SATA 6Gb/s) 1 x 2230 M.2 E-Key 1 x Full-size Mini PCIe with SIM slot
<b>Internal I/O</b>	1 x 4-pin box power connector (+9V~36VDC) 1 x SATA power header 1 x CPU fan header 1 x System fan header 1 x Front panel header 1 x Front panel audio header 1 x 2W Speaker out header 4 x USB 2.0 headers 2 x COM headers (RS-232) 2 x COM headers (RS-232/422/485 & RI/5V/12V) 1 x Backlight Control header 1 x AT/ATX mode select jumper 1 x eDP/HDMI jumper 1 x GPIO (8 bits) & SMBUS header 1 x Buzzer	1 x 4-pin box power connector (+9V~36VDC) 1 x SATA power header 1 x CPU fan header 1 x System fan header 1 x Front panel header 1 x Front panel audio header 1 x 2W Speaker out header 4 x USB 2.0 headers 2 x COM headers (RS-232) 2 x COM headers (RS-232/422/485 & RI/5V/12V) 1 x Backlight Control header 1 x AT/ATX mode select jumper 1 x eDP/HDMI jumper 1 x GPIO (8 bits) & SMBUS header 1 x Buzzer
<b>Rear I/O</b>	4 x HDMI 2 x RJ45 LAN ports 2 x USB 3.0	3 x HDMI 2 x RJ45 LAN ports 2 x USB 3.0
<b>TPM</b>	Onboard TPM 2.0 security chip INFINEON SLB9665TT.0	Onboard TPM 2.0 security chip INFINEON SLB9665TT.0
<b>Operating Temp.</b>	0°C to 60°C	0°C to 60°C
<b>Ordering Information</b>	9MRZNVMSNR-SI (Bulk packing) 9MRZNVMSMR-SI (Box packing)	9MRZNRMSMR-SI (Box packing)
<b>Heatsink P/N</b>	25ST1-113104-A7R	TBD
<b>Fan Module P/N</b>	12SF2-01A073-00R	12SF2-01A073-00R
<b>Heat Spreader P/N</b>	25ST5-QP1600-A8R	TBD



## QBiP Wide Temperature Series



Model Name	QBiP-7200AT/ QBiP-7100AT	QBiP-E3940AT	QBiP-1900AT
<b>CPU</b>	Intel® Core™ i5-7200U Processor, 14nm, 2 cores, 4 threads up to 3.1 GHz, TDP 15W (QBiP-7200AT) Intel® Core™ i3-7100U Processor, 14nm, 2 cores, 4 threads, up to 2.4 GHz, TDP 15W (QBiP-7100AT)	Intel® Atom® x5-E3940 Processor, 14nm, 4 cores, 4 threads, up to 1.8 GHz, TDP 9.5W	Intel® Celeron® Processor J1900, 22nm, 4 cores, 4 threads, up to 2.42 GHz, TDP 10W
<b>Socket</b>	FCBGA1356	FCBGA1296	FCBGA1170
<b>Chipset</b>	SoC	SoC	SoC
<b>Memory</b>	2 x DDR4 SO-DIMM sockets, Max. Capacity 32 GB, Support Dual Channel DDR4 2133 MHz	2 x DDR3L SO-DIMM sockets, Max. Capacity 8 GB, Support Dual Channel DDR3L 1866 MHz	1 x DDR3L SO-DIMM socket, Max. Capacity 8 GB, Support Single Channel DDR3L 1333 MHz
<b>Ethernet</b>	2 x GbE LAN ports (Intel® I219V and Intel® I211AT)	2 x GbE LAN ports (Intel® I211AT)	2 x GbE LAN ports (Intel® I211AT)
<b>Graphic</b>	Integrated Graphics Processor - Intel® HD Graphics 620: 1 x HDMI 2.0, 1 x Display Port, 1 x LVDS 3 independent display outputs	Integrated Graphics Processor - Intel® HD Graphics 500: 1 x HDMI 1.4, 1 x VGA, 1 x LVDS 3 independent display outputs	Integrated Graphics Processor - Intel® HD Graphics: 1 x HDMI 1.4, 1 x VGA, 1 x LVDS 2 independent display outputs
<b>Audio</b>	Realtek® ALC269	Realtek® ALC269	Realtek® ALC269
<b>Storage</b>	2 x SATA 6Gb/s ports (RAID 0/1/5)	1 x SATA 6Gb/s port	1 x SATA 3Gb/s port
<b>Expansion Slots</b>	1 x 2280 M.2 M-Key (PCIe x4, SATA 6Gb/s) 1 x 2230 M.2 E-Key 1 x Full-size Mini PCIe with SIM slot	1 x 2242 M.2 M-Key (SATA 6Gb/s) 1 x Full-size Mini PCIe with SIM slot	1 x 2280 M.2 M-Key (SATA 3Gb/s) 1 x Full-size Mini PCIe with SIM slot
<b>Internal I/O</b>	1 x 4-pin box power connector (+9V~36VDC) 2 x SATA power headers 1 x CPU fan header 1 x System fan header 1 x Front panel header 1 x Front panel audio header 1 x 2W Speaker out header 2 x USB 2.0 headers 2 x COM headers (RS-232) 3 x COM headers (RS-232) 1 x Backlight Control header 1 x AT/ATX mode select jumper 1 x GPIO (8 bits) & SMBUS header	1 x 4-pin box power connector (+9V~36VDC) 1 x SATA power header 1 x System fan header 1 x Front panel header 1 x Front panel audio header 1 x 2W Speaker out header 4 x USB 2.0 headers 3 x COM headers (RS-232) 1 x COM header (RS-232/422/485 & RI/5V/12V) 1 x Backlight Control header 1 x AT/ATX mode select jumper 1 x GPIO (8 bits) & SMBUS header 1 x Buzzer header	1 x 4-pin box power connector (+9V~36VDC) (+48VDC optional) 1 x SATA power header 1 x System fan header 1 x Front panel header 1 x Front panel audio header 1 x 2W Speaker out header 4 x USB 2.0 headers 3 x COM headers (RS-232) 1 x COM header (RS-232/422/485 & RI/5V/12V) 1 x Backlight Control header 1 x AT/ATX mode select jumper 1 x GPIO (8 bits) & SMBUS header 1 x Buzzer header
<b>Rear I/O</b>	1 x COM port (RS-232/422/485 & RI/5V/12V) 1 x HDMI, 1 x Display Port 2 x RJ45 LAN ports, 4 x USB 3.0	1 x Headphone Jack 1 x HDMI, 1 x VGA 2 x RJ45 LAN ports 2 x USB 3.0	1 x Headphone Jack 1 x HDMI, 1 x VGA 2 x RJ45 LAN ports 1 x USB 2.0, 1 x USB 3.0
<b>TPM</b>	1 x TPM header	1 x TPM header	1 x TPM header
<b>Operating Temp.</b>	-20°C to 70°C	-40°C to 85°C	-40°C to 85°C
<b>Ordering Information</b>	9MFLP5ASMR-SI1 (Box packing) (QBiP-7200AT) 9MFLP3ASMR-SI1 (Box packing) (QBiP-7100AT)	9MAPLKASMR-SI1 (Box packing)	9MBAYTASMR-SI1 (Box packing)
<b>Heatsink P/N</b>	255T1-153108-A7R	255T1-113103-A7R	255T1-153107-A7R
<b>Fan Module P/N</b>	12SF2-01A073-00R	—	—
<b>Heat Spreader P/N</b>	255T5-CKAC00-A8R	—	255T5-CBAB00-A8R

## QBi Series (10 x 10 Embedded Compact Board)



QBi Series (10 x 10 Embedded Compact Board)

Model Name	QBi-8565A/ QBi-8265A/ QBi-8145A	QBi-7100B	QBi-3965B
<b>CPU</b>	Intel® Core™ i7-8565U Processor 14nm, 4 cores, 8 threads, up to 4.6 GHz, TDP 15W (QBi-8565A) Intel® Core™ i5-8265U Processor 14nm, 4 cores, 8 threads, up to 3.9 GHz, TDP 15W (QBi-8265A) Intel® Core™ i3-8145UE Processor 14nm, 2 cores, 4 threads, up to 3.9 GHz, TDP 15W (QBi-8145A)	Intel® Core™ i3-7100U Processor, 14nm, 2 cores, 4 threads, 2.4 GHz, TDP 15W	Intel® Celeron® Processor 3965U 14nm, 2 cores, 2 threads, 2.2 GHz, TDP 15W
<b>Socket</b>	FCBGA1528	FCBGA1356	FCBGA1356
<b>Chipset</b>	—	—	—
<b>Memory</b>	2 x DDR4 SO-DIMM sockets, Max. Capacity 32 GB, Support Dual Channel DDR4 2400 MHz	2 x DDR4 SO-DIMM sockets, Max. Capacity 32 GB, Support Dual Channel DDR4 2133 MHz	2 x DDR4 SO-DIMM sockets, Max. Capacity 32 GB, Support Dual Channel DDR4 2133 MHz
<b>Ethernet</b>	2 x GbE LAN ports (Intel® I219V and Realtek® RTL8111HS)	1 x GbE LAN port (Intel® I219V)	1 x GbE LAN port (Intel® I219V)
<b>Graphic</b>	Integrated Graphics Processor - Intel® UHD Graphics 620: 2 x HDMI 1.4 1 x eDP 3 independent display outputs	Integrated Graphics Processor - Intel® HD Graphics 620: 1 x HDMI 2.0 1 x Mini Display Port 1 x eDP 3 independent display outputs	Integrated Graphics Processor - Intel® HD Graphics 620: 1 x HDMI 2.0 1 x Mini Display Port 1 x eDP 3 independent display outputs
<b>Audio</b>	Realtek® ALC269	Intel® Integrated Audio	Intel® Integrated Audio
<b>Storage</b>	1 x SATA 6Gb/s ports (RAID 0/1)	1 x SATA 6Gb/s port (RAID 0/1)	1 x SATA 6Gb/s port
<b>Expansion Slots</b>	1 x 2280 M.2 M-Key (PCIe x4, SATA 6Gb/s) 1 x 2230 M.2 E-Key	1 x 2280 M.2 M-Key (PCIe x4, SATA 6Gb/s) 1 x 2230 M.2 E-Key	1 x 2280 M.2 M-Key (SATA 6Gb/s) 1 x 2230 M.2 E-Key
<b>Internal I/O</b>	1 x 2-pin power connector 1 x SATA/eDP power header 1 x CPU fan header 1 x Front panel header 1 x Front panel audio header/ GPIO (8 bits) & SMBUS header 1 x USB 2.0 header 1 x Vertical USB 3.0 (Flexible to PCIe x1)	1 x 2-pin power connector 1 x SATA power header 1 x CPU fan header 1 x Front panel header 2 x USB 2.0 headers 1 x USB 3.0 header 1 x COM header (RS-232)	1 x 2-pin power connector 1 x SATA power header 1 x CPU fan header 1 x Front panel header 2 x USB 2.0 headers 1 x USB 3.0 header 1 x COM header (RS-232)
<b>Front IO</b>	2 x USB 3.1 Gen2 1 x Power button 1 x COM port (RS-232/422/485)	2 x USB 3.0 1 x Power button	2 x USB 3.0 1 x Power button
<b>Rear IO</b>	2 x HDMI 2 x RJ45 LAN ports 2 x USB 3.1 Gen2 1 x Screw type DC Jack (+9V~36VDC)	1 x HDMI 2.0 1 x Mini Display Port 1 x RJ45 LAN port 2 x USB 3.0 1 x DC Jack (+12V~24VDC)	1 x HDMI 2.0 1 x Mini Display Port 1 x RJ45 LAN port 2 x USB 3.0 1 x DC Jack (+12V~24VDC)
<b>Side IO</b>	—	—	—
<b>TPM</b>	—	—	—
<b>Operating Temp.</b>	0°C to 60°C	0°C to 60°C	0°C to 60°C
<b>Ordering Information</b>	9MWHLUAHMR-SI (Box packing) (QBi-8565A) 9MWHLUBHMR-SI (Box packing) (QBi-8265A) 9MWHLUCHMR-SI (Box packing) (QBi-8145A)	9MFLP3AHNR-SI (Bulk packing)	9MFLPCAHR-SI (Box packing)
<b>Heatsink P/N</b>	—	—	—
<b>Fan Module P/N</b>	—	25ST4-343202-C1R	25ST4-343202-C1R
<b>Heat Spreader P/N</b>	—	25ST5-CKAA01-A8R	25ST5-CKAA01-A8R

## QBi Series (10 x 10 Embedded Compact Board)



Model Name	QBi-5005A/ QBi-5005B/ QBi-4000B	QBi-4200A/ QBi-4200B	QBi-4125A
<b>CPU</b>	Intel® Pentium® Silver J5005 Processor, 4 cores, 4 threads, up to 2.80 GHz, TDP 10W (QBi-5005A/ QBi-5005B) Intel® Celeron® Processor N4000, 2 Cores, 2 threads, up to 2.60 GHz, TDP 6W (QBi-4000B)	Intel® Pentium® Processor N4000 14nm, 4 cores, 4 threads, up to 2.5 GHz, TDP 6W	Intel® Pentium® Silver J4125 Processor, 14nm, 4 cores, 4 threads, up to 2.7 GHz, TDP 10W
<b>Socket</b>	FCBGA1090	FCBGA1296	FCBGA1090
<b>Chipset</b>	—	—	SoC
<b>Memory</b>	1 x DDR4 SO-DIMM socket, Max. Capacity 8 GB, Support Single Channel DDR4 2400 MHz	1 x DDR3L SO-DIMM socket, Max. Capacity 8 GB, Support Single Channel DDR3L 1866 MHz	1 x DDR4 SO-DIMM socket, Max. Capacity 8 GB, Support Single Channel DDR4 2400 MHz
<b>Ethernet</b>	1 x GbE LAN port (Realtek® RTL8111HS)	1 x GbE LAN port (Realtek® RTL8111HS)	2 x GbE LAN ports (Intel® I211AT and Realtek®RTL8111HS)
<b>Graphic</b>	QBi-5005A/ 5005B: Integrated Graphics Processor - Intel® UHD Graphics 605: QBi-4000B: Integrated Graphics Processor - Intel® UHD Graphics 600: 1 x HDMI 1.4, 1 x VGA, 1 x eDP 3 independent display outputs	Integrated Graphics Processor - Intel® HD Graphics 505: 1 x HDMI 1.4 1 x VGA 1 x eDP 3 independent display outputs	Integrated Graphics Processor - Intel® UHD Graphics 605: 2 x HDMI 1.4, 1 x eDP 3 independent display outputs"
<b>Audio</b>	Realtek® ALC891	Realtek® ALC255	Realtek® ALC269
<b>Storage</b>	1 x SATA 6Gb/s port (7-pin) 1 x SATA 6Gb/s port (FFC) 1 x eMMC 32GB (5005A only)	1 x SATA 6Gb/s port 1 x eMMC 32GB (4200A only)	1 x 2.5" HDD/SSD (SATA 6Gb/s)
<b>Expansion Slots</b>	1 x 2230 M.2 E-Key	1 x 2230 M.2 E-Key	1 x 2280 M.2 M-Key (SATA 6Gb/s) 1 x 2230 M.2 E-Key
<b>Internal I/O</b>	1 x 2-pin power connector (Optional) 1 x SATA power header 1 x CPU fan header 1 x Front panel header 2 x USB 2.0 headers	1 x 2-pin power connector 1 x SATA power header 1 x CPU fan header 1 x Front panel header 2 x USB 2.0 headers 1 x USB 3.0 header 1 x COM header (RS-232)	1 x 2-pin power connector 1 x SATA Power header 1 x CPU fan header 1 x Front panel header 2 x USB 2.0 headers 1 x Speaker out header
<b>Front IO</b>	2 x USB 3.0 1 x Power button 1 x COM port (RS-232) 1 x Headphone Jack, 1 x Microphone Jack	2 x USB 3.0 1 x Power button 1 x Audio Combo Jack (Headphone & Microphone)	2 x USB 3.0 1 x COM (RS-232) 1 x Headphone Jack 1 x Power button
<b>Rear IO</b>	1 x HDMI 1 x VGA 1 x RJ45 LAN port 2 x USB 3.0	1 x HDMI 1 x VGA 1 x RJ45 LAN port : 2 x USB 3.0	2 x RJ45 LAN ports 2 x USB 3.0 2 x HDMI 1 x DC Jack (+12V~19VDC)
<b>Side IO</b>	1 x DC Jack (+12V~19VDC)	1 x DC Jack (+12V~24VDC)	—
<b>TPM</b>	—	—	—
<b>Operating Temp.</b>	0°C to 60°C	0°C to 60°C	0°C to 60°C
<b>Ordering Information</b>	9MZGLKAHNR-SI (Bulk packing) (QBi-5005A) 9MZGLKCHMR-SI (Box packing) (QBi-5005B) 9MZGLKBHMR-SI (Box packing) (QBi-4000B)	9MZAPLAHNR-SI (Bulk packing) (QBi-4200A) 9MZAPLBHMR-SI (Box packing) (QBi-4200B)	9MGMLKAHMR-SI (Box packing) (QBi-4125A)
<b>Heatsink P/N</b>	12SP2-090019-00R	12SP2-090018-00R	12SP2-090018-00R
<b>Fan Module P/N</b>	—	—	TBD
<b>Heat Spreader P/N</b>	25ST5-CGAA00-A8R	25ST5-CGAA00-A8R	25ST5-CGAA00-A8R

**GIGAIPC**

**GIGABYTE™**  
G R O U P

Building  
a **SMARTER** Tomorrow



**GIGAIPC**

**GIGAIPC CO., LTD.**

GIGABYTE TECHNOLOGY GROUP

B1-A, No.205, Sec. 3, Beixin Rd., Xindian Dist.,  
New Taipei City 23143, Taiwan (R.O.C)

TEL: +886-2-89131312    FAX: +886-2-89131332  
Email: [sales@gigaipc.com](mailto:sales@gigaipc.com)    URL: [www.gigaipc.com](http://www.gigaipc.com)

技宸股份有限公司

技嘉集團

新北市 231 新店區北新路三段 205 號 B1-A

TEL: +886-2-89131312    FAX: +886-2-89131332  
Email: [sales@gigaipc.com](mailto:sales@gigaipc.com)    URL: [www.gigaipc.com](http://www.gigaipc.com)



GMKT-C2020002