



Building a Smarter Tomorrow



 IoT Solutions
Alliance

2021 Product Catalog 1H



www.gigaipc.com

Company Profile



GIGAIPC, established in 2018 as an independent IPC-focused spin-off from GIGABYTE, is driven by a passion for technology and agile intuition of our customer's requirements. GIGAIPC has an exceptionally sophisticated Research & Development department, enabling us to keep up with the rapid pace of today's technology. Combined with our outstanding research and design ability, GIGAIPC also has an award-winning Taiwan-based manufacturing facility, synchronizing with GIGAIPC's R&D department to deliver high quality and reliable products. GIGAIPC is a young and energetic organization driven by surpassing our customer's expectations, and we promise to offer our customers not only high-quality computing platforms but also world-class service and support. As a result, GIGAIPC's service centers have been established in most major cities worldwide, and our global presence is still being actively expanding, all ready to offer the best service to our customers.



Company Profile/ Naming Rule

GIGAIPC is an Associate member of the Intel® Internet of Things Solutions Alliance.



“Building a SMARTER Tomorrow”

The strengths of GIGAIPC are based on the advantages, skills and expertise we have built to realize this vision, including being customer focused and striving for high quality. GIGAIPC is determined to keep reinforcing these strengths as our principles to achieve maximum customer satisfaction.

Key Advantages to work with GIGAIPC

Technology	<ol style="list-style-type: none"> 1. Intel®, AMD etc. Key vendor direct support 2. Latest technical and over 10 years RD development experiences 3. Large coverage rate of design verification
Flexibility	<ol style="list-style-type: none"> 1. Huge off-the-shelf products combination and rich ODM/OEM experiences 2. Multiple manufacturing sites for different high-mix and low-volume requirements 3. Task-force team with multiple functions to align customer's requirements
Quality	<ol style="list-style-type: none"> 1. Component IPC, audit and approval system 2. Rich resources and equipments on design and manufacture quality system 3. Emphasizing closed-loop of PDCA cycle for continuous improvement
Service	<ol style="list-style-type: none"> 1. Worldwide RMA service coverage more than 80 service centers globally
Capability	<ol style="list-style-type: none"> 1. Customization capability 2. Direct field application engineer support and quick response 3. Customized manufacturing process, quality control and delivery solutions

Motherboard's Naming Rule -

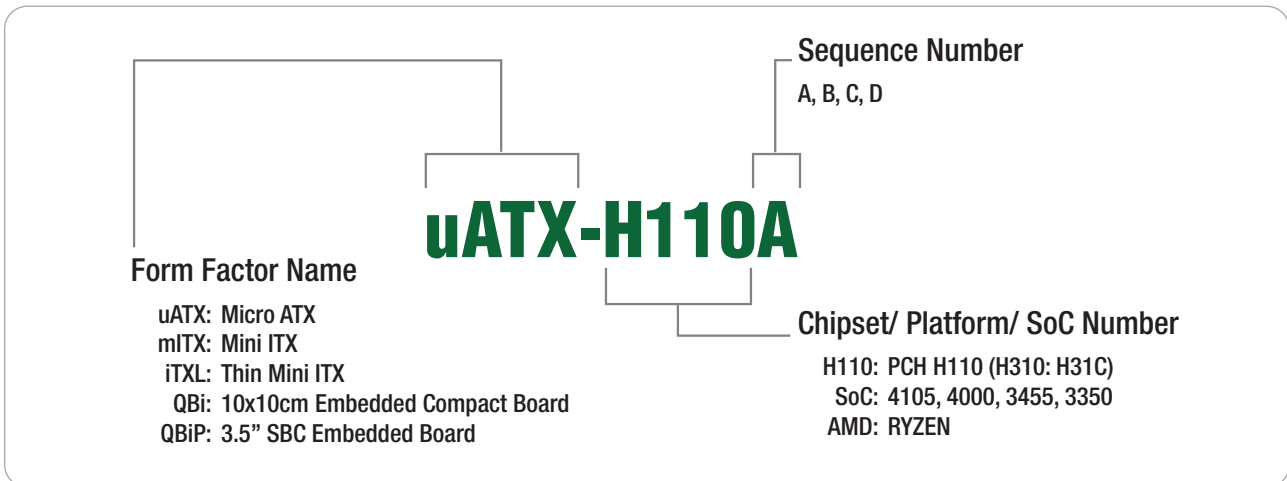

System's Naming Rule -

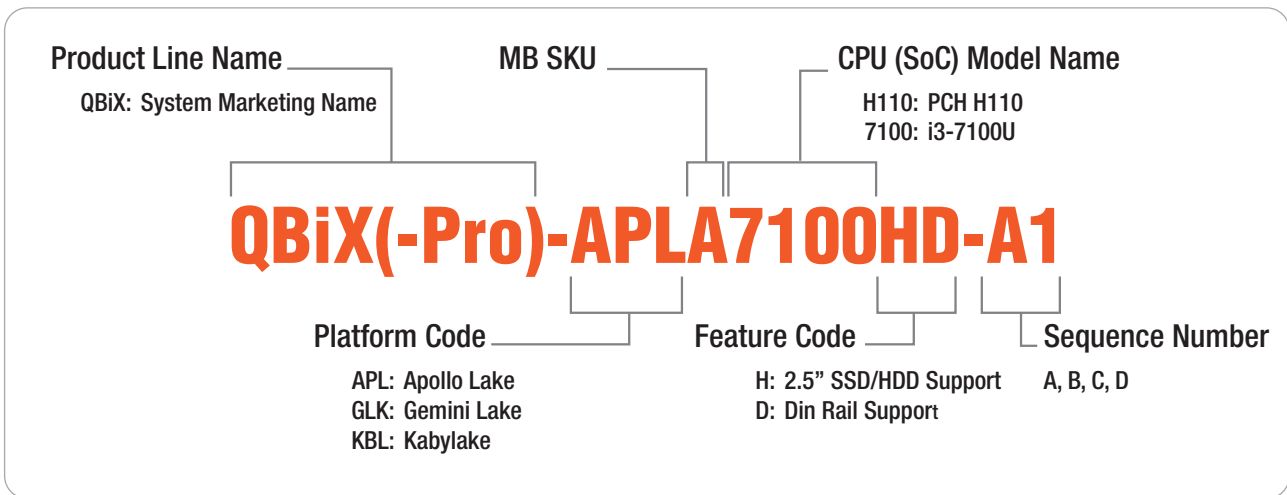

Motherboard's Form Factor -

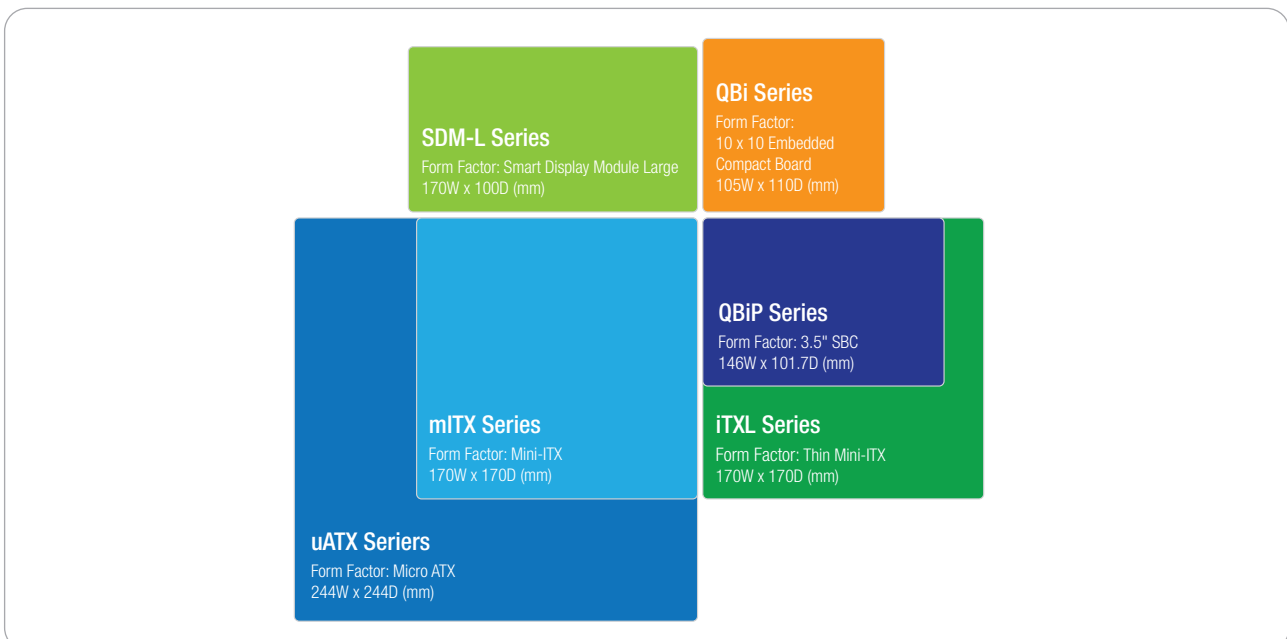

Company Profile	1	QBiX-WP Series	17
Product's Naming Rule	2	QBiX-WP-WHLA8265H-A1	17
Index	3	QBiX-WP-APLA3940H-A1	17
Index	4	QBiX-Jetson Series.....	18
QBiX Series	5	QBiX-Jetson-Nano	18
QBiX-WHLA8565H-A1	5	QBiX-Jetson-Xavier NX	18
QBiX-WHLA8265H-A1	5	Embedded IoT Series	19
QBiX-WHLA8145H-A1	5	EL-30-4200 (rev. 1.0)	
QBiX-KBLA7100H-A1	5	EL-30-3350 (rev. 1.0)	19
QBiX-GLKB4125-A1	5	EL-20-3710-32G (rev. 1.0)	
QBiX2-GLKA5005H-A1	6	EL-20-3060-32G (rev. 1.0)	19
QBiX-GLKA5005H-A1	6	QBiX-Plus Series	20
QBiX-APLA4200H-A1	6	QBiX-Plus-KBLA7100-A1	20
QBiX-Pro Series	7	QBiX-Plus-APLA3450-A1	20
QBiX-Pro-TGLA1115G4EH-A1/A2.....	7	QBiX-Lite Series	21
QBiX-Pro-WHLA8565H-A1	7	QBiX-Lite-TGLA.....	21
QBiX-Pro-WHLA8265H-A1	7	QBiX-Lite-AMDA1605H-A1	21
QBiX-Pro-WHLA8145H-A1	7	QBiX-Lite SDM Kits	22
QBiX-Pro-WHLA8565H-A2.....	7	SDM-L Series	23
QBiX-Pro-WHLA8265H-A2	7	SDM-1135G7L	23
QBiX-Pro-WHLA8145H-A2	7	SDM-1115G4L	23
QBiX2-Pro-KBLB7100H-A1	8	SDM-7300L.....	23
QBiX-Pro-KBLB7200H-A2.....	8	SDM-7100L	23
QBiX-Pro-KBLB7100H-A1.....	8	SDM-4000L	23
QBiX-Pro-KBLB7100H-B1	9	SDM-3350L-QV.....	24
QBiX-Pro-KBLB3965H-A1	9	SDM-3350L-HW.....	24
QBiX2-Pro-APLB4200H-A1.....	9	SDM Docking Board	24
QBiX-Pro-APLB4200H-A1	10	Smart Whiteboard Series.....	26
QBiX-Pro-APLB4200H-B1.....	10	GSW-A55S7300-A1	26
QBiX-Pro-BYTA1900H-A1	10	GSW-A55S7100-A1	26
QBiX-Pro-AMDA1605H-A1.....	11	GSW-A55S4000-A1	26
QBiX-Pro-AMDA1606H-A1.....	11	GSW-A65S7300-A1	27
QBiX-Pro-KBLB7100HD-A1	12	GSW-A65S7100-A1	27
QBiX-Pro-GLKA5040HD-A1	12	GSW-A65S4000-A1	27
QBiX-Pro-BYTA1900HD-A1	12	GSW-A75S7300-A1	28
QBiX-EXP-TGLA1115G4EH-A1.....	13	GSW-A75S7100-A1	28
GSW-A75S4000-A1	28	Micro-ATX Series	29
QBiX-ITX Series.....	14	uATX-Q47EA	29
QBiX-ITX-Chassis Kit.....	14	uATX-H410A	29
Peripheral.....	14	uATX-X570A.....	29
External Discrete GPU BOX Kit.....	14	uATX-Q370A.....	30
QBiX-Jumbo Series	15	uATX-H370A	30
QBiX-JMB-CFLA310H-A1.....	15	uATX-H310A	30
QBiX-JMB-CFLA310HG-A1	15		
QBiX-JWB-SKYA110H-A1	16		
QBiX-JWB-SKYB110H-A1.....	16		

Micro-ATX Series31

uATX-H110A	31
uATX-H81A	31
uATX-RYZEN	31

Mini-ITX Series32

mITX-Q47EA	32
mITX-Q370A.....	32
mITX-H310A	32
mITX-Q170A	33
mITX-H110A	33
mITX-H110B	33
mITX-4125A	34
mITX-4205A.....	34
mITX-1900A.....	35
mITX-1605A	35

Thin Mini-ITX Series36

iTXL-Q47EA.....	36
iTXL-Q370A.....	36
iTXL-Q170A.....	36
iTXL-H110C	37
iTXL-6100B	37
iTXL-3955A	37
iTXL-3350A	38
iTXL-1900A	38

QBiP Series (3.5" SBC)39

QBiP-TGLA	39
QBiP-TGLB	39
QBiP-8565A/ QBiP-8265A/ QBiP-8145A.....	40
QBiP-7600A/ QBiP-7200A/ QBiP-7100A	40
QBiP-7100B	41
QBiP-3965A	41
QBiP-4200A.....	41
QBiP-4200B/ QBiP-4200C/ QBiP-3350A.....	42
QBiP-E3940A.....	42
QBiP-1900A	42
QBiP-1605A	43
QBiP-1606A	43
QBiP-7200AT/ QBiP-7100AT	44
QBiP-E3940AT	44
QBiP-1900AT	44

QBi Series (10 x 10 Embedded Compact Board) 45

QBi-8565A/ QBi-8265A/ QBi-8145A.....	45
QBi-7100B	45
QBi-3965B	45
QBi-5005A/ QBi-5005B/ QBi-4000B.....	46
QBi-4200A/ QBi-4200B.....	46
QBi-4125A	46

QBiX Series



QBiX Series

Model Name	QBiX-WHLA8565H-A1 QBiX-WHLA8265H-A1 QBiX-WHLA8145H-A1	QBiX-KBLA7100H-A1	QBiX-GLKB4125-A1
Dimension	138W x 118D x 74.2H (mm)	138W x 118D x 74.2H (mm)	118W x 109.4D x 44.4H (mm)
CPU	Intel® Core™ i7-8565U Processor, 14nm, 4 cores, 8 threads, up to 4.6 GHz, TDP 15W Intel® Core™ i5-8265U Processor, 14nm, 4 cores, 8 threads, up to 3.9 GHz, TDP 15W Intel® Core™ i3-8145UE Processor, 14nm, 2 cores, 4 threads, up to 3.9 GHz, TDP 15W	Intel® Core™ i3-7100U Processor, 14nm, 2 cores, 4 threads, up to 2.4 GHz, TDP 15W	Intel® Celeron® J4125 Processor, 14nm, 4 cores, 4 threads, up to 2.7 GHz, TDP 10W
Chipset	SoC	SoC	SoC
Memory	2 x DDR4 SO-DIMM sockets, Max. Capacity 32 GB, Support Dual Channel DDR4 2400 MHz	2 x DDR4 SO-DIMM sockets, Max. Capacity 32 GB, Support Dual Channel DDR4 2133 MHz	1 x DDR4 SO-DIMM socket, Max. Capacity 8 GB, Support Single Channel DDR4 2400 MHz
Ethernet	2 x GbE LAN ports (Intel® I219V and Realtek® RTL8111HS)	1 x GbE LAN port (Intel® I219V)	2 x GbE LAN ports (Intel® I211AT and Realtek® RTL8111HS)
Graphic	Integrated Graphics Processor - Intel® UHD Graphics 620: 2 x HDMI 1.4 2 independent display outputs	Integrated Graphics Processor - Intel® HD Graphics 620: 1 x HDMI 2.0 1 x Mini Display Port 2 independent display outputs	Integrated Graphics Processor - Intel® UHD Graphics 600: 2 x HDMI 1.43 2 independent display outputs
Audio	Realtek® Audio Codec	Intel® Integrated Audio	Realtek® Audio Codec
Storage	1 x 2.5" HDD/SSD(SATA 6Gb/s)	1 x 2.5" HDD/SSD(SATA 6Gb/s)	—
Expansion Slots	1 x 2280 M.2 M-Key (PCIe x4, SATA 6Gb/s) 1 x 2230 M.2 E-Key 1 x Vertical USB 3.0	1 x 2280 M.2 M-Key (PCIe x4, SATA 6Gb/s) 1 x 2230 M.2 E-Key	1 x 2280 M.2 M-Key (SATA 6Gb/s) 1 x 2230 M.2 E-Key
Front I/O	2 x USB 3.1 Gen2 1 x Power switch 2 x External Antenna Holes (Optional) 1 x HDD LED 1 x COM port (RS-232/422/485) 1 x Headphone Jack	2 x USB 3.0 1 x Power switch 2 x External Antenna Holes (Optional) 1 x Power LED 1 x HDD LED	2 x USB 3.0 1 x COM Port (RS-232) 1 x Headphone Jack 1 x Power button with LED
Rear I/O	2 x HDMI 2 x RJ45 LAN ports 2 x USB 3.1 Gen2 1 x Screw Type DC Jack	1 x RJ45 LAN port 2 x USB 3.0 1 x HDMI 1 x Mini Display port 1 x COM port (RS-232) 1 x Screw Type DC Jack	2 x RJ45 LAN ports 2 x USB 3.0 2 x HDMI 2 x External Antenna Hole (Optional) 1 x Screw Type DC Jack
Side I/O	—	—	—
TPM	—	—	—
Power	+9V~36VDC (Adapter 19V/90W)	+12V~24VDC (Adapter 19V/65W)	+12V~19VDC (Adapter 19V/65W)
Operating Temp.	0°C to 50°C	0°C to 50°C	0°C to 50°C
Mounting	Wall mount	Wall mount	VESA 75/100
Ordering Information	6BQB8565AMR-SI (Box packing) 6BQB8265AMR-SI (Box packing) 6BQB8145AMR-SI (Box packing)	6BCKAAMR-SI (Box packing)	6BQB4125AMR-SI (Box packing)
Built-in Components	—	—	—

QBiX Series



Model Name	QBiX2-GLKA5005H-A1	QBiX-GLKA5005H-A1	QBiX-APLA4200H-A1
Dimension	118W x 109.4D x 74.4H (mm)	118W x 109.4D x 54.4H (mm)	118W x 109.4D x 54.4H (mm)
CPU	Intel® Pentium® Silver J5005 Processor, 14nm, 4 cores, 4 threads, up to 2.8 GHz, TDP 10W	Intel® Pentium® Silver J5005 Processor, 14nm, 4 cores, 4 threads, up to 2.8 GHz, TDP 10W	Intel® Pentium® N4200 Processor, 14nm, 4 cores, 4 threads, up to 2.5 GHz, TDP 6W
Chipset	SoC	SoC	SoC
Memory	1 x DDR4 SO-DIMM socket, Max. Capacity 8 GB, Support Single Channel DDR4 2400 MHz	1 x DDR4 SO-DIMM socket, Max. Capacity 8 GB, Support Single Channel DDR4 2400 MHz	1 x DDR3L SO-DIMM socket, Max. Capacity 8 GB, Support Single Channel DDR3L 1866MHz
Ethernet	1 x GbE LAN port (Realtek® RTL8111HS)	1 x GbE LAN port (Realtek® RTL8111HS)	1 x GbE LAN port (Realtek® RTL8111HS)
Graphic	Integrated Graphics Processor - Intel® UHD Graphics 605: 1 x HDMI 1.4 1 x VGA 2 independent display outputs	Integrated Graphics Processor - Intel® UHD Graphics 605: 1 x HDMI 1.4 1 x VGA 2 independent display outputs	Integrated Graphics Processor - Intel® HD Graphics 505: 1 x HDMI 1.4 1 x VGA 2 independent display outputs
Audio	Realtek® Audio Codec	Realtek® Audio Codec	Realtek® Audio Codec
Storage	1 x 2.5" HDD/SSD (SATA 6Gb/s)	1 x 2.5" HDD/SSD (SATA 6Gb/s)	1 x 2.5" HDD/SSD (SATA 6Gb/s)
Expansion Slots	1 x 2230 M.2 E-Key	1 x 2230 M.2 E-Key	1 x 2230 M.2 E-Key
Front I/O	2 x USB 3.0 2 x USB 2.0 3 x COM ports (RS-232) 1 x Headphone Jack 1 x Microphone Jack 1 x Power button with LED	2 x USB 3.0 1 x COM port (RS-232) 1 x Headphone Jack 1 x Microphone Jack 1 x Power button with LED	2 x USB 3.0 1 x Power button with LED 1 x Headphone Jack
Rear I/O	1 x RJ45 LAN port 2 x USB 3.0 1 x HDMI 1 x VGA 2 x External Antenna Holes (Optional) 2 x COM ports (RS-232) 1 x Screw Type DC Jack	1 x RJ45 LAN port 2 x USB 3.0 1 x HDMI 1 x VGA 2 x External Antenna Holes (Optional)	1 x RJ45 LAN port 2 x USB 3.0 1 x HDMI 1 x VGA 2 x External Antenna Holes (Optional)
Side I/O	2 x USB 2.0 1 x RJ11 Cash Draw	1 x DC Jack	1 x DC Jack
TPM	—	—	—
Power	+19VDC (Adapter 19V/65W)	+12V~19VDC (Adapter 19V/65W)	+12V~24VDC (Adapter 19V/65W)
Operating Temp.	0°C to 50°C	0°C to 50°C	0°C to 50°C
Mounting	VESA 75/100	VESA 75/100	VESA 75/100
Ordering Information	9BQ25005AMR-SI (Box packing)	6BCGAAMR-SI (Box packing)	6BCBAAMR-SI (Box packing)
Built-in Components	Memory: 4GB DDR4 SO-DIMM Storage: 128GB M.2 SSD	—	—

QBiX-Pro Series



QBiX-Pro Series

Model Name	QBiX-Pro-TGLA1115G4EH-A1/A2	QBiX-Pro-WHLA8565H-A1 QBiX-Pro-WHLA8265H-A1 QBiX-Pro-WHLA8145H-A1	QBiX-Pro-WHLA8565H-A2 QBiX-Pro-WHLA8265H-A2 QBiX-Pro-WHLA8145H-A2
Dimension	178W x 125D x 52.7H (mm)	178W x 125D x 52.7H (mm)	178W x 125D x 52.7H (mm)
CPU	Intel® Core™ i3-1115G4E Processor, 10nm SuperFin, 2 cores, 4 threads, 2.2GHz, up to 3.9GHz, TDP 15W	Intel® Core™ i7-8565U Processor, 14nm, 4 cores, 8 threads 1.8GHz, up to 4.6 GHz, TDP 15W Intel® Core™ i5-8265U Processor, 14nm, 4 cores, 8 threads 1.6GHz, up to 3.9 GHz, TDP 15W Intel® Core™ i3-8145UE Processor, 14nm, 2 cores, 4 threads 2.2GHz up to 3.9 GHz, TDP 15W	Intel® Core™ i7-8565U Processor 14nm, 4 cores, 8 threads 1.8GHz, up to 4.6 GHz, TDP 15W Intel® Core™ i5-8265U Processor 14nm, 4 cores, 8 threads 1.6GHz, up to 3.9 GHz, TDP 15W Intel® Core™ i3-8145UE Processor 14nm, 2 cores, 4 threads 2.2GHz up to 3.9 GHz, TDP 15W
Chipset	SoC	SoC	SoC
Memory	2 x DDR4 SO-DIMM sockets, Max. Capacity 64 GB, Support Dual Channel DDR4 3200 MHz	2 x DDR4 SO-DIMM sockets, Max. Capacity 32 GB, Support Dual Channel DDR4 2400 MHz	2 x DDR4 SO-DIMM sockets, Max. Capacity 32 GB, Support Dual Channel DDR4 2400 MHz
Ethernet	2 x GbE LAN ports (Intel® I219V and Intel® I211AT)	2 x GbE LAN ports (Intel® I219V and Intel® I211AT)	2 x GbE LAN ports (Intel® I219V and Intel® I211AT)
Graphic	Integrated Graphics Processor - Intel® Iris X® Graphics 2 x HDMI 2.0 2 independent display outputs	Integrated Graphics Processor - Intel® UHD Graphics 620: 2 x HDMI 1.4 2 independent display outputs	Integrated Graphics Processor - Intel® UHD Graphics 620: 2 x HDMI 1.4 2 independent display outputs
Audio	Realtek® Audio Codec	Realtek® Audio Codec	Realtek® Audio Codec
Storage	1 x SATA 6Gb/s ports	1 x 2.5" HDD/SSD (SATA 6Gb/s)	1 x 2.5" HDD/SSD (SATA 6Gb/s)
Expansion Slots	1 x 2280 M.2 M-Key (PCIe x2, SATA 6Gb/s) 1 x 2230 M.2 E-Key 1 x Full-size Mini PCIe with SIM slot	1 x 2280 M.2 M-Key (PCIe x4, SATA 6Gb/s) 1 x 2230 M.2 E-Key 1 x Full-size Mini PCIe with SIM slot	1 x 2280 M.2 M-Key (PCIe x4, SATA 6Gb/s) 1 x 2230 M.2 E-Key 1 x Full-size Mini PCIe with SIM slot
Front I/O	2 x RJ45 LAN ports 4 x USB 3.2 Gen2x1 Gen2 2 x HDMI 1 x Power button with LED 1 x HDD LED 1 x COM port (RS-232/422/485 & RI/5V/12V)	2 x RJ45 LAN ports 4 x USB 3.1 Gen2 2 x HDMI 1 x Power switch 1 x Power & HDD LED 1 x COM port (RS-232/422/485 & RI/5V/12V)	2 x RJ45 LAN ports 4 x USB 3.1 Gen2 2 x HDMI 1 x Power switch 1 x Power & HDD LED 1 x COM port (RS-232/422/485 & RI/5V/12V)
Rear I/O	2 x USB 2.0 2 x COM ports (RS-232/422/485) 1 x GPIO (8 bits) 1 x Headphone Jack 1 x Terminal Block/Screw Type DC Jack	2 x USB 2.0 2 x COM ports (RS-232) 1 x GPIO (8 bits) 1 x Headphone Jack 1 x 3-pin Terminal Block	2 x USB 2.0 2 x COM ports (RS-232) 1 x GPIO (8 bits) 1 x Headphone Jack 1 x Screw Type DC Jack
Side I/O	2 x External Antenna Holes (Optional)	2 x External Antenna Holes (Optional)	2 x External Antenna Holes (Optional)
TPM	—	—	—
Power	+9V~48VDC (Full Range)	+9V~36VDC (Adapter 19V/90W)	+9V~36VDC (Full Range)
Operating Temp.	0°C to 50°C	0°C to 50°C	0°C to 50°C
Mounting	Wall mount (Optional)	Wall mount (Optional)	Wall mount (Optional)
Ordering Information	—	6BQP8565AMR-SI (Box packing) 6BQP8265AMR-SI (Box packing) 6BQP8145AMR-SI (Box packing)	6BQP8565AMR-SI (Box packing) 6BQP8265AMR-SI (Box packing) 6BQP8145AMR-SI (Box packing)
Built-in COM portponents	—	—	—

QBiX-Pro Series



Model Name	QBiX2-Pro-KBLB7100H-A1	QBiX-Pro-KBLB7200H-A2	QBiX-Pro-KBLB7100H-A1
Dimension	178W x 125D x 90.2H (mm)	178W x 125D x 52.7H (mm)	178W x 125D x 52.7H (mm)
CPU	Intel® Core™ i3-7100U Processor, 14nm, 2 cores, 4 threads, up to 2.4 GHz, TDP 15W	Intel® Core™ i5-7200U Processor, 14nm, 2 cores, 4 threads, up to 3.1 GHz, TDP 15W	Intel® Core™ i3-7100U Processor, 14nm, 2 cores, 4 threads, up to 2.4 GHz, TDP 15W
Chipset	SoC	SoC	SoC
Memory	2 x DDR4 SO-DIMM sockets, Max. Capacity 32 GB, Support Dual Channel DDR4 2133 MHz	2 x DDR4 SO-DIMM sockets, Max. Capacity 32 GB, Support Dual Channel DDR4 2133 MHz	2 x DDR4 SO-DIMM sockets, Max. Capacity 32 GB, Support Dual Channel DDR4 2133 MHz
Ethernet	2 x GbE LAN ports (Intel® I219V and Intel® I211AT)	2 x GbE LAN ports (Intel® I219V and Intel® I211AT)	2 x GbE LAN ports (Intel® I219V and Intel® I211AT)
Graphic	Integrated Graphics Processor - Intel® HD Graphics 620: 1 x HDMI 2.0, 1 x Display Port 2 independent display outputs	Integrated Graphics Processor - Intel® HD Graphics 620: 1 x HDMI 2.0, 1 x Display Port 2 independent display outputs	Integrated Graphics Processor - Intel® HD Graphics 620: 1 x HDMI 2.0, 1 x Display Port 2 independent display outputs
Audio	Realtek® Audio Codec	Realtek® Audio Codec	Realtek® Audio Codec
Storage	1 x 2.5" HDD/SSD (SATA 6Gb/s)	1 x 2.5" HDD/SSD (SATA 6Gb/s)	1 x 2.5" HDD/SSD (SATA 6Gb/s)
Expansion Slots	1 x 2280 M.2 M-Key (PCIe x4, SATA 6Gb/s) 1 x 2230 M.2 E-Key 1 x Full-size Mini PCIe with SIM slot	1 x 2280 M.2 M-Key (PCIe x4, SATA 6Gb/s) 1 x 2230 M.2 E-Key 1 x Full-size Mini PCIe with SIM slot	1 x 2280 M.2 M-Key (PCIe x4, SATA 6Gb/s) 1 x 2230 M.2 E-Key 1 x Full-size Mini PCIe with SIM slot
Front I/O	2 x RJ45 LAN ports 4 x USB 3.0 1 x HDMI 1 x Display Port 1 x Power switch 1 x Power & HDD LED 1 x COM port (RS-232/422/485 & RI/5V/12V) 4 x COM ports (RS-232/422/485)	2 x RJ45 LAN ports 4 x USB 3.0 1 x HDMI 1 x Display Port 1 x Power switch 1 x Power & HDD LED 1 x COM port (RS-232/422/485 & RI/5V/12V)	2 x RJ45 LAN ports 4 x USB 3.0 1 x HDMI 1 x Display Port 1 x Power switch 1 x Power & HDD LED 1 x COM port (RS-232/422/485 & RI/5V/12V)
Rear I/O	4 x USB 2.0 3 x COM ports (RS-232) 1 x GPIO (8 bits), SMBUS & Remote control 1 x 3-pin Terminal Block	2 x USB 2.0 3 x COM ports (RS-232) 1 x Screw Type DC Jack	2 x USB 2.0 3 x COM ports (RS-232) 1 x 3-pin Terminal Block
Side I/O	2 x External Antenna Holes (Optional)	2 x External Antenna Holes (Optional)	2 x External Antenna Holes (Optional)
TPM	—	—	—
Power	+9V~36VDC (Full Range)	+9V~36VDC (Adapter 19V/65W)	+9V~36VDC (Full Range)
Operating Temp.	0°C to 50°C	0°C to 50°C	0°C to 50°C
Mounting	Wall mount (Optional)	Wall mount (Optional)	Wall mount (Optional)
Ordering Information	9BQD7100AMR-SI (Box packing)	6BQP7200AMR-SI (Box packing)	6BCKACMR-SI (Box packing)
Built-in COM portponents	Memory: 4GB DDR4 SO-DIMM Storage: 128GB M.2 SSD	—	—

QBiX-Pro Series



QBiX-Pro Series

Model Name	QBiX-Pro-KBLB7100H-B1	QBiX-Pro-KBLB3965H-A1	QBiX2-Pro-APLB4200H-A1
Dimension	178W x 125D x 52.7H (mm)	178W x 125D x 52.7H (mm)	178W x 125D x 90.2H (mm)
CPU	Intel® Core™ i3-7100U Processor, 14nm, 2 cores, 4 threads, up to 2.4 GHz, TDP 15W	Intel® Celeron® 3965U Processor, 14nm, 2 cores, 2 threads, up to 2.2 GHz, TDP 15W	Intel® Pentium® N4200 Processor, 14nm, 4 cores, 4 threads, up to 2.5 GHz, TDP 6W
Chipset	SoC	SoC	SoC
Memory	2 x DDR4 SO-DIMM sockets, Max. Capacity 32 GB, Support Dual Channel DDR4 2133 MHz	2 x DDR4 SO-DIMM sockets, Max. Capacity 32 GB, Support Dual Channel DDR4 2133 MHz	2 x DDR3L SO-DIMM sockets, Max. Capacity 8 GB, Support Dual Channel DDR3L 1866 MHz
Ethernet	2 x GbE LAN ports (Intel® I219V and Intel® I211AT)	2 x GbE LAN ports (Intel® I219V and Intel® I211AT)	2 x GbE LAN ports (Intel® I211AT)
Graphic	Integrated Graphics Processor - Intel® HD Graphics 620: 1 x HDMI 2.0, 1 x Display Port 2 independent display outputs	Integrated Graphics Processor - Intel® HD Graphics 610: 1 x HDMI 2.0, 1 x Display Port 2 independent display outputs	Integrated Graphics Processor - Intel® HD Graphics 505: 1 x HDMI 1.4, 1 x VGA 2 independent display outputs
Audio	Realtek® Audio Codec	Realtek® Audio Codec	Realtek® Audio Codec
Storage	1 x 2.5" HDD/SSD (SATA 6Gb/s)	1 x 2.5" HDD/SSD (SATA 6Gb/s)	1 x 2.5" HDD/SSD (SATA 6Gb/s)
Expansion Slots	1 x 2280 M.2 M-Key (PCIe x4, SATA 6Gb/s) 1 x 2230 M.2 E-Key 1 x Full-size Mini PCIe with SIM slot	1 x 2280 M.2 M-Key (SATA 6Gb/s) 1 x 2230 M.2 E-Key 1 x Full-size Mini PCIe with SIM slot	1 x 2242 M.2 M-Key (SATA 6Gb/s) 1 x Full-size Mini PCIe with SIM slot
Front I/O	2 x RJ45 LAN ports 4 x USB 3.0 1 x HDMI 1 x Display Port 1 x Power switch 1 x Power & HDD LED 1 x COM port (RS-232/422/485 & RI/5V/12V)	2 x RJ45 LAN ports 4 x USB 3.0 1 x HDMI 1 x Display Port 1 x Power switch 1 x Power & HDD LED 1 x COM port (RS-232/422/485 & RI/5V/12V)	2 x RJ45 LAN ports 2 x USB 3.0 1 x HDMI 1 x VGA 1 x Power switch 1 x Power & HDD LED 1 x Headphone Jack 4 x COM ports (RS-232/422/485 & RI/5V/12V)
Rear I/O	2 x USB 2.0 2 x COM ports (RS-232) 1 x GPIO (8 bits) 1 x Line out 1 x 3-pin Terminal Block	2 x USB 2.0 3 x COM ports (RS-232) 1 x 3-pin Terminal Block	6 x USB 2.0 1 x COM port (RS-232/422/485 & RI/5V/12V) 3 x COM ports (RS-232) 1 x GPIO (8 bits), SMBUS & Remote control 1 x 3-pin Terminal Block
Side I/O	2 x External Antenna Holes (Optional)	2 x External Antenna Holes (Optional)	2 x External Antenna Holes (Optional)
TPM	—	—	—
Power	+9V~36VDC (Full Range)	+9V~36VDC (Full Range)	+9V~36VDC (Full Range)
Operating Temp.	0°C to 50°C	0°C to 50°C	0°C to 50°C
Mounting	Wall mount (Optional)	Wall mount (Optional)	Wall mount (Optional)
Ordering Information	6BQP7100BMR-SI (Box packing)	6BQP3965AMR-SI (Box packing)	9BQD4200AMR-SI (Box packing)
Built-in COM Portponents	—	—	Memory: 4GB DDR3L SO-DIMM Storage: 128GB M.2 SSD

QBiX-Pro Series



Model Name	QBiX-Pro-APLB4200H-A1	QBiX-Pro-APLB4200H-B1	QBiX-Pro-BYTA1900H-A1
Dimension	178W x 125D x 52.7H (mm)	178W x 125D x 52.7H (mm)	178W x 125D x 52.7H (mm)
CPU	Intel® Pentium® N4200 Processor, 14nm, 4 cores, 4 threads, up to 2.5 GHz, TDP 6W	Intel® Pentium® N4200 Processor, 14nm, 4 cores, 4 threads, up to 2.5 GHz, TDP 6W	Intel® Celeron® J1900 Processor, 22nm, 4 cores, 4 threads, up to 2.42 GHz, TDP 10W
Chipset	SoC	SoC	SoC
Memory	2 x DDR3L SO-DIMM sockets, Max. Capacity 8 GB, Support Dual Channel DDR3L 1866 MHz	2 x DDR3L SO-DIMM sockets, Max. Capacity 8 GB, Support Dual Channel DDR3L 1866 MHz	1 x DDR3L SO-DIMM socket, Max. Capacity 8 GB, Support Single Channel DDR3L 1333MHz
Ethernet	2 x GbE LAN ports (Intel® I211AT)	2 x GbE LAN ports (Intel® I211AT)	2 x GbE LAN ports (Intel® I211AT)
Graphic	Integrated Graphics Processor - Intel® HD Graphics 505: 1 x HDMI 1.4 1 x VGA 2 independent display outputs	Integrated Graphics Processor - Intel® HD Graphics 505: 1 x HDMI 1.4 1 x VGA 2 independent display outputs	Integrated Graphics Processor - Intel® HD Graphics: 1 x HDMI 1.4 1 x VGA 2 independent display outputs
Audio	Realtek® Audio Codec	Realtek® Audio Codec	Realtek® Audio Codec
Storage	1 x 2.5" HDD/SSD (SATA 6Gb/s)	1 x 2.5" HDD/SSD (SATA 6Gb/s)	1 x 2.5" HDD/SSD (SATA 3Gb/s)
Expansion Slots	1 x 2242 M.2 M-Key (SATA 6Gb/s) 1 x Full-size Mini PCIe with SIM slot	1 x 2242 M.2 M-Key (SATA 6Gb/s) 1 x Full-size Mini PCIe with SIM slot	1 x 2280 M.2 M-Key (SATA 3Gb/s) 1 x Full-size Mini PCIe with SIM slot
Front I/O	2 x RJ45 LAN ports 2 x USB 3.0 1 x HDMI 1 x VGA 1 x Power switch 1 x Power & HDD LED 1 x Headphone Jack	2 x RJ45 LAN ports 2 x USB 3.0 1 x HDMI 1 x VGA 1 x Power switch 1 x Power & HDD LED 1 x Line out	2 x RJ45 LAN ports 1 x USB 3.0 1 x USB 2.0 1 x HDMI 1 x VGA 1 x Power switch 1 x Power & HDD LED 1 x Line out
Rear I/O	2 x USB 2.0 1 x COM port (RS-232/422/485 & RI/5V/12V) 3 x COM ports (RS-232) 1 x 3-pin Terminal Block	2 x USB 2.0 1 x COM port (RS-232/422/485 & RI/5V/12V) 2 x COM ports (RS-232) 1 x GPIO (8 bits) 1 x 3-pin Terminal Block	2 x USB 2.0 1 x COM port (RS-232 & RI/5V/12V) 3 x COM ports (RS-232) 1 x 3-pin Terminal Block
Side I/O	2 x External Antenna Holes (Optional)	2 x External Antenna Holes (Optional)	2 x External Antenna Holes (Optional)
TPM	—	—	—
Power	+9V~36VDC (Full Range)	+9V~36VDC (Full Range)	+9V~36VDC (Full Range)
Operating Temp.	0°C to 50°C	0°C to 50°C	0°C to 50°C
Mounting	Wall mount (Optional)	Wall mount (Optional)	Wall mount (Optional)
Ordering Information	6BCBABMR-SI (Box packing)	6BQP4200BMR-SI (Box packing)	6BQP1900AMR-SI (Box packing)
Built-in Components	—	—	—

QBiX-Pro Series



QBiX-Pro Series

Model Name	QBiX-Pro-AMDA1605H-A1	QBiX-Pro-AMDA1606H-A1
Dimension	178W x 125D x 52.7H (mm)	178W x 125D x 52.7H (mm)
CPU	AMD® RYZEN™ Embedded V1605B, 14nm, 4 cores, 8 threads, 2.0 GHz, up to 3.6 GHz, TDP 25W	AMD® RYZEN™ Embedded R1606G, 14nm, 2 cores, 4 threads, 2.6 GHz, up to 3.5 GHz, TDP 25W
Chipset	SoC	SoC
Memory	2 x DDR4 SO-DIMM sockets, Max. Capacity 32 GB, Support Dual Channel DDR4 2400 MHz	2 x DDR4 SO-DIMM sockets, Max. Capacity 32 GB, Support Dual Channel DDR4 2400 MHz
Ethernet	2 x GbE LAN port (Realtek® RTL8111HS)	2 x GbE LAN port (Realtek® RTL8111HS)
Graphic	Integrated Graphics Processor- AMD® Radeon™ Vega 8 Graphics: 4 x HDMI 2.0 4 independent display outputs	Integrated Graphics Processor- AMD® Radeon™ Vega 3 Graphics: 3 x HDMI 2.0 3 independent display outputs
Audio	Realtek® Audio Codec	Realtek® Audio Codec
Storage	1 x 2.5" HDD/SSD (SATA 6Gb/s)	1 x 2.5" HDD/SSD (SATA 6Gb/s)
Expansion Slots	1 x 2280 M.2 M-Key (PCIe x4, SATA 6Gb/s) 1 x 2230 M.2 E-Key 1 x Full-size Mini PCIe with SIM slot	1 x 2280 M.2 M-Key (PCIe x4, SATA 6Gb/s) 1 x 2230 M.2 E-Key 1 x Full-size Mini PCIe with SIM slot
Front I/O	2 x RJ45 LAN ports 2 x USB 3.0 4 x HDMI 1 x Power switch 1 x Power & HDD LED	2 x RJ45 LAN ports 2 x USB 3.0 3 x HDMI 1 x Power switch 1 x Power & HDD LED
Rear I/O	2 x USB 2.0 2 x COM ports (RS-232/422/485 & RI/5V/12V) 2 x COM ports (RS-232) 1 x Screw Type DC Jack	2 x USB 2.0 2 x COM ports (RS-232/422/485 & RI/5V/12V) 1 x GPIO (8 bits) 1 x Headphone Jack 1 x Screw Type DC Jack
Side I/O	2 x External Antenna Holes (Optional)	2 x External Antenna Holes (Optional)
TPM	Onboard TPM 2.0 security chip INFINEON SLB9665TT2.0	Onboard TPM 2.0 security chip INFINEON SLB9665TT2.0
Power	+9V~36VDC (Adapter 19V/65W)	+9V~36VDC (Adapter 19V/65W)
Operating Temp.	0°C to 50°C	0°C to 50°C
Mounting	Wall mount (Optional)	Wall mount (Optional)
Ordering Information	6BQP1605AMR-SI (Box packing)	6BQP1606AMR-SI (Box packing)
Built-in Components	—	—

QBiX-Pro Series



Model Name	QBiX-Pro-KBLB7100HD-A1	QBiX-Pro-GLKA5040HD-A1	QBiX-Pro-BYTA1900HD-A1
Dimension	160W x 118D x 62.6H (mm)	160W x 118D x 62.6H (mm)	160W x 118D x 62.6H (mm)
CPU	Intel® Core™ i3-7100U Processor, 14nm, 2 cores, 4 threads, up to 2.40 GHz, TDP 15W	Intel® Pentium® Silver J5040 Processor, 14nm, 4 cores, 4 threads, up to 3.2 GHz, TDP 10W	Intel® Celeron® J1900 Processor, 22nm, 4 cores, 4 threads, up to 2.42 GHz, TDP 10W
Chipset	SoC	SoC	SoC
Memory	2 x DDR4 SO-DIMM sockets, Max. Capacity 32 GB, Support Dual Channel DDR4 2133 MHz	1 x DDR4 SO-DIMM socket, Max. Capacity 8 GB, Support Single Channel DDR4 2400 MHz	1 x DDR3L SO-DIMM socket, Max. Capacity 8 GB, Support Single Channel DDR3L 1333 MHz
Ethernet	2 x GbE LAN ports (Intel® I219V and Intel® I211AT)	2 x GbE LAN ports (Intel® I211AT)	2 x GbE LAN ports (Intel® I211AT)
Graphic	Integrated Graphics Processor - Intel® HD Graphics 620 support 1 x HDMI 2.0 1 x Display Port 2 independent display outputs	Integrated Graphics Processor - Intel® UHD Graphics 605: 1 x HDMI 1.4 1 x VGA 2 independent display outputs	Integrated Graphics Processor - Intel® HD Graphics: 1 x HDMI 1.4 1 x VGA 2 independent display outputs
Audio	Realtek® Audio Codec	Realtek® Audio Codec	Realtek® Audio Codec
Storage	1 x 2.5" HDD/SSD (SATA 6Gb/s)	1 x 2.5" HDD/SSD (SATA 6Gb/s)	1 x 2.5" HDD/SSD (SATA 3Gb/s)
Expansion Slots	1 x 2280 M.2 M-Key (PCIe x4, SATA 6Gb/s) 1 x 2230 M.2 E-Key 1 x 3052 M.2 B-Key with SIM slot (Full-size mPCIe optional)	1 x 2280 M.2 M-Key (SATA 6Gb/s) 1 x 2230 M.2 E-Key 1 x Full-size miniPCIe with SIM slot 1 x Vertical USB 2.0	1 x 2280 M.2 M-Key (SATA 3Gb/s) 1 x Full-size Mini PCIe with SIM slot
Front I/O	2 x RJ45 LAN ports 4 x USB 3.0 2 x USB 2.0 1 x HDMI 1 x Display Port 1 x COM port (RS-232/422/485 & RI/5V/12V) 1 x COM ports (RS-232/422/485) 1 x Power switch 1 x HDD LED 1 x Line out	2 x RJ45 LAN ports 4 x USB 3.0 1 x HDMI 1 x VGA 2 x COM ports (RS-232/422/485 & RI/5V/12V) 1 x Power switch with LED 1 x WiFi/HDD LED 1 x Remote control pin 1 x Headphone Jack 1 x External Antenna Hole (Optional)	2 x RJ45 LAN ports 1 x USB 3.0 3 x USB 2.0 1 x HDMI 1 x VGA 1 x COM port (RS-232/422/485 & RI/5V/12V) 1 x COM port (RS-232) 1 x Power button 1 x HDD LED 1 x Headphone Jack
Rear I/O	1 x DIN Rail Mounting Support	1 x Din Rail Mounting Support	1 x Din Rail Mounting Support
Side I/O	1 x GPIO (8 bits) 1 x 3-pin Terminal Block 5 x External Antenna Hole (Optional)	1 x GPIO (8 bits) 1 x 3-pin Terminal Block 2 x COM ports (RS-232/422/485) 2 x External Antenna Holes (Optional)	1 x GPIO (8 bits) 1 x 3-pin Terminal Block 3 x External Antenna Holes (Optional)
TPM	—	—	—
Power	+9V~36VDC (Full Range)	+9V~36VDC (Full Range)	+9V~36VDC (Full Range)
Operating Temp.	0°C to 50°C	0°C to 50°C	0°C to 50°C
Mounting	DIN Rail/ Wall mount (Optional)	DIN Rail/ Wall mount (Optional)	DIN Rail/ Wall mount (Optional)
Ordering Information	6BQP7100CMR-SI (Box packing)	6BQP5040AMR-SI (Box packing)	6BQP1900BMR-SI (Box packing)
Built-in Components	—	—	—

QBiX-Expert



QBiX-Expert

Model Name	QBiX-EXP-TGLA1115G4EH-A1
Dimension	210.36W x 165D x 65H (mm)
CPU	Intel® Core™ i3-1115G4E Processor, 10nm SuperFin, 2 cores, 4 threads, 2.2GHz, up to 3.9GHz, TDP 15W
Chipset	SoC
Memory	2 x DDR4 SO-DIMM sockets, Max. Capacity 32 GB, Support Dual Channel DDR4 2933 MHz
Ethernet	4 x GbE LAN ports (Intel® I211AT)
Graphic	Integrated Graphics Processor - Intel® Iris X® Graphics 2 x HDMI 2.0 2 independent display outputs
Audio	Realtek® Audio Codec
Storage	1 x Swappable 2.5" HDD/SDD (SATA 6Gb/s ports)
Expansion Slots	1 x 2280 M.2 M-Key (PCIe x4, SATA 6Gb/s) 1 x 2230 M.2 E-Key 1 x Full-size Mini PCIe with SIM slot
Front I/O	4 x RJ45 LAN ports (PoE 802.3af/port) 4 x USB 2.0 1 x Power switch with LED 1 x HDD LED 1 x COM (RS-232/422/485) 1 x GPIO (8 bits) 2 x Antenna (Optional) 1 x 2.5" SSD/HDD SATA Extention
Rear I/O	2 x RJ45 LAN ports 4 x USB 3.1 Gen2 1 x COM (RS-232/422/485 & RI/5V/12V) 2 x COM (RS-232/422/485) 1 x 3-pin Terminal Block
Side I/O	4 x External Antenna Hole (Optional)
TPM	—
Power	+12V~24VDC
Operating Temp.	0°C to 50°C
Mounting	Wall mount (Optional)
Ordering Information	—
Built-in Components	—

QBiX-ITX Series

Peripheral



Market Name	QBiX-ITX-Chassis Kit	Model Name	External Discrete GPU BOX Kit
Dimension	210W x 200D x 58H (mm)	Dimension	172W x 370D x 102.5H (mm)
Support Model	mITX-Q370A mITX-H310A mITX-Q170A mITX-H110B mITX-1605A	GFX Support	Full Length 300mm Max 260W Graphic Card
Chipset	Refer to MB	I/O	4 x Ext. Mini SAS HD Port (PCIe x16)
Storage Drive Bay	1 x 2.5" Drive Bay	PCIe support	PCIe x16
Expansion Slots	Refer to Motherboard	Power	Flex ATX PSU 400W/500W (Optional)
Front I/O	4 x USB 2.0 1 x Power button with LED 1 x Power / HDD LED	Operating Temp.	0°C to 35°C
Rear I/O	2 x External Antenna hole Others are refer to Motherboard		
Side I/O	—		
TPM	Refer to Motherboard		
Power	Refer to Motherboard		
Operating Temp.	0°C to 50°C		
Mounting	Wall Mount, VESA 75/100		
Ordering Information	6BQIH310AMR-SI (Box packing)-MITX-H310A		
Built-in COM portponents	—		

QBiX-Jumbo Series



QBiX-Jumbo Series

Model Name	QBiX-JMB-CFLA310H-A1	QBiX-JMB-CFLA310HG-A1
Dimension	224W x 257D x 91H (mm)	224W x 343D x 146H (mm) (Discrete GFX Max. 250W)
CPU	Support for 8th/9th Generation Intel® Core™ i7/ i5/ i3 processors in the LGA1151 package, TDP under 65W	Support for 8th/9th Generation Intel® Core™ i7/ i5/ i3 processors in the LGA1151 package, TDP under 65W
Chipset	Intel® H310 Chipset	Intel® H310 Chipset
Memory	2 x DDR4 SO-DIMM sockets, Max. Capacity 32 GB, Support Dual Channel DDR4 2666/2400 MHz	2 x DDR4 SO-DIMM sockets, Max. Capacity 32 GB, Support Dual Channel DDR4 2666/2400 MHz
Ethernet	4 x GbE LAN ports (1 x Intel® I219V and 3 x Intel® I211AT)	4 x GbE LAN ports (1 x Intel® I219V and 3 x Intel® I211AT)
Graphic	Integrated Graphics Processor - Intel® HD Graphics: 1 x Display Port 1 x DVI-D 1 x VGA 2 independent display outputs	Integrated Graphics Processor - Intel® HD Graphics: 1 x Display Port 1 x DVI-D 1 x VGA 2 independent display outputs
Audio	Realtek® Audio Codec	Realtek® Audio Codec
Storage	3 x 2.5" HDD/SSD (SATA 6Gb/s) 1 x 2280 M.2 M-Key (SATA 6Gb/s) 1 x 2230 M.2 E-Key	3 x 2.5" HDD/SSD (SATA 6Gb/s) 1 x 2280 M.2 M-Key (SATA 6Gb/s) 1 x 2230 M.2 E-Key
Expansion Slots	1 x Full-size Mini PCIe with SIM slot	1 x Full-size Mini PCIe with SIM slot 1 x PCIe x4 (Gen3 x1) 1 x PCIe x16 (Gen3 x16)
Front I/O	1 x Power Switch/ Power/ HDD LED 3 x Audio Jacks (Line in, Line out, Mic in) 1 x Display Port 1 x DVI-D 1 x VGA 2 x COM ports (RS-232/422/485 & RI/5V/12V) 2 x COM ports (RS-232) 4 x RJ45 LAN ports 4 x USB 3.0 4 x USB 2.0 1 x 4-pin Terminal Block 2 x External Antenna Hole (Optional)	1 x Power Switch/ Power/ HDD LED 3 x Audio Jacks (Line in, Line out, Mic in) 1 x Display Port 1 x DVI-D 1 x VGA 2 x COM ports (RS-232/422/485 & RI/5V/12V) 2 x COM ports (RS-232) 4 x RJ45 LAN ports 4 x USB 3.0 4 x USB 2.0 1 x 4-pin Terminal Block 2 x External Antenna Hole (Optional)
Rear I/O	—	—
Power	+12V~48VDC (Full Range) -20°C to 50°C (CPU TDP 65W) -20°C to 60°C (CPU TDP 35W)	+24V~36VDC (Full Range) -20°C to 50°C (CPU TDP 65W) -20°C to 60°C (CPU TDP 35W)
Operating Temp.	-20°C to 50°C (CPU TDP 35W, i3-8100T, Tj 82°C)	-20°C to 50°C (CPU TDP 35W, i3-8100T, Tj 82°C) -20°C to 60°C (With Optional Expansion Kit)
Ordering Information	9BQJH310AMR-SI (Box Packing)	9BQJH310AMR-SI 6BQJH310APR-SI
Build in Components	CPU: Intel® Core™ i3-9100E Processor, 6M cache, 3.1GHz Memory: 8G DDR4 SO-DIMM	CPU: Intel® Core™ i3-9100E Processor, 6M cache, 3.1GHz Memory: 8G DDR4 SO-DIMM

QBiX-Jumbo Series



Model Name	QBiX-JWB-SKYA110H-A1	QBiX-JWB-SKYB110H-A1
Dimension	273W x 203D x 91H(mm)	273W x 203D x 91H(mm)
CPU	Supports for 6/7th Generation Intel® Core™ i7/ i5/ i3, Pentium® & Celeron® processors, TDP under 35W	Supports for 6/7th Generation Intel® Core™ i7/ i5/ i3, Pentium® & Celeron® processors, TDP under 35W
Chipset	Intel® H110 Chipset	Intel® H110 Chipset
Memory	2 x DDR4 SO-DIMM sockets, Max. Capacity 32 GB, Support Dual Channel DDR4 2400/2133 MHz	2 x DDR4 SO-DIMM sockets, Max. Capacity 32 GB, Support Dual Channel DDR4 2400/2133 MHz
Ethernet	2 x GbE LAN ports (Intel® I219V and Intel® I211AT)	6 x GbE LAN ports (1 x Intel® I219V and 5 x Intel® I211AT)
Graphic	Integrated Graphics Processor - Intel® HD Graphics: 1 x HDMI 1.4 1 x Display Port 1 x VGA 1 x LVDS 2 independent display outputs	Integrated Graphics Processor - Intel® HD Graphics: 1 x HDMI 1.4 1 x VGA 2 independent display outputs
Audio	Realtek® Audio Codec	Realtek® Audio Codec
Storage	2 x 2.5" HDD/SSD (SATA 6Gb/s)	2 x 2.5" HDD/SSD (SATA 6Gb/s)
Expansion Slots	1 x 2280 M.2 M-Key (SATA 6Gb/s) 1 x Full/Half-size Mini PCIe with SIM slot	1 x 2280/2242 M.2 M-Key (SATA 6Gb/s) 1 x Full-size mSATA
Front I/O	1 x Power Switch 1 x Power & HDD LED 2 x Remote control header 4 x USB 2.0 4 x COM ports (RS-232/422/485) 1 x COM port (RS-232) 1 x GPIO (8 bit) 2 x External Antenna Hole (Optional)	1 x Power Switch 1 x Power & HDD LED 2 x Remote control header 4 x USB 2.0 4 x COM ports (RS-232/422/485) 2 x COM ports (RS-232/422/485 & RI/5V/12V) 1 x GPIO (8 bit) 2 x External Antenna Hole (Optional)
Rear I/O	3 x Audio Jacks (Line in, Line out, Mic in) 1 x VGA 1 x HDMI 1 x Display Port 1 x LVDS 1 x COM port (RS-232/422/485 & RI/5V/12V) 2 x RJ45 LAN ports 2 x USB 3.0 2 x USB 2.0 1 x 3-pin Terminal Block 2 x External Antenna Hole (Optional)	3 x Audio Jacks (Line in, Line out, Mic in) 1 x VGA 1 x HDMI 6 x RJ45 LAN ports 4 x USB 3.0 1 x 3-pin Terminal Block 2 x External Antenna Hole (Optional)
Power	+12V/+19V/+24VDC	+12V/+19V/+24VDC
Operating Temp.	0°C to 50°C	0°C to 50°C
Ordering Information	9BQJH110AMR-SI (Box packing)	9BQJH110BMR-SI (Box packing)
Build in Components	CPU: Intel® Core™ i3-7100T Processor, 3M Cache, 3.40 GHz Memory: 4GB DDR4 SO-DIMM Storage: 128GB M.2 SSD	CPU: Intel® Core™ i3-7100T Processor, 3M Cache, 3.40 GHz Memory: 4GB DDR4 SO-DIMM Storage: 128GB M.2 SSD

QBiX-WP Series



QBiX-WP series/QBiX-Jetson series

Model Name	QBiX-WP-WHLA8265H-A1	QBiX-WP-APLA3940H-A1
Dimension	188W x 155D x 72H (mm)	188W x 155D x 72H (mm)
CPU	Intel® Core™ i5-8265U Processor, 14nm, 4 cores, 8 threads, up to 3.9 GHz, TDP 15W	Intel® Atom® x5-E3940 Processor, 14nm, 4 cores, 4 threads, up to 1.8 GHz, TDP 9.5W
Chipset	—	—
Memory	2 x DDR4 SO-DIMM sockets, Max. Capacity 32 GB, Support Dual Channel DDR4 2400MHz	2 x DDR3L SO-DIMM sockets, Max. Capacity 8 GB, Support Dual Channel DDR3L 1866 MHz
Ethernet	2 x GbE LAN ports (Intel® I219V and Intel® I211AT)	2 x GbE LAN ports (Intel® I211AT)
Graphic	Integrated Graphics Processor - Intel® UHD Graphics 620: 1 x HDMI 1.4	Integrated Graphics Processor - Intel® HD Graphics 500: 1 x HDMI 1.4
Audio	Realtek® Audio Codec	Realtek® Audio Codec
Storage	1 x 2.5" HDD/SSD (SATA 6Gb/s)	1 x 2.5" HDD/SSD (SATA 6Gb/s)
Expansion Slots	1 x 2280 M.2 M-Key (PCIe x4, SATA 6Gb/s) 1 x 2230 M.2 E-Key 1 x Full-size miniPCIe with SIM slot	1 x 2242 M.2 M-Key (SATA 6Gb/s) 1 x Full-size miniPCIe with SIM slot
Front I/O	2 x (M12) RJ45 LAN ports 2 x (IP67) USB 2.0 connector 1 x (IP67) HDMI connector 1 x (IP67) Power switch 1 x (M8) Power & HDD LED	2 x (M12) RJ45 LAN ports 1 x (IP67) USB 2.0 connector 1 x (IP67) HDMI connector 1 x (IP67) Power switch 1 x (M8) Power & HDD LED
Rear I/O	1 x (M12) COM (RS-232/422/485 & RI/5V/12V) 2 x (M12) COM (RS-232) 1 x (M12) GPIO (8 bits) 1 x (M12) DC IN	1 x (M12) COM (RS-232/422/485 & RI/5V/12V) 2 x (M12) COM (RS-232) 1 x (M12) GPIO (8 bits) 1 x (M12) DC Jack
Power	+9V~36VDC	+9V~36VDC
Operating Temp.	-20°C to 70°C	-20°C to 80°C
Ordering Information	9BQW8265AMR-SI (Box packing)	9BQW3940AMR-SI (Box packing)
Build in Components	Memory : 8GB DDR4 SO-DIMM Storage : 256GB M.2 SSD	Memory : 8GB DDR3L SO-DIMM Storage : 256GB M.2 SSD

QBiX-Jetson Series



Model Name	QBiX-Jetson-Nano	QBiX-Jetson-Xavier NX
Dimension	210W x 170D x 55H (mm)	210W x 170D x 55H (mm)
CPU	Nvidia jetson Nano 128-core NVIDIA Maxwell™ GPU	Nvidia jetson Xavier NX 384-core NVIDIA Volta™ GPU with 48 Tensor Cores
Chipset	—	—
Memory	4GB LPDDR4 (module)	8GB LPDDR4 (module)
Ethernet	8 x GbE LAN with PoE 15W (POE optional) 2 x GbE LAN	8 x GbE LAN with PoE 15W (POE optional) 2 x GbE LAN
Graphic	—	—
Audio	—	—
Storage	1 x eMMC 5.1 (module) 1 x SATA 6Gb/s (SATA Extension)	1 x eMMC 5.1 (module) 1 x SATA 6Gb/s (SATA Extension)
Expansion Slots	1 x M.2 B Key 3052 (USB3.2 Gen1x1) 1 x Mini PCIe (USB2.0 only) 1 x M.2 E Key 2230 - Intel AC 8265 (Optional) 1 x SIM slot	1 x M.2 B Key 3052 (PCIe X1+ USB3.2 Gen1x1) 1 x Mini PCIe (USB2.0 only) 1 x M.2 E Key 2230 - Intel AC 8265 (Optional) 1 x SIM slot
Front I/O	1 x Micro SD card 1 x Micro USB 2.0 (OTD) 1 x HDMI 2.0 1 x Display Port 1 x Power switch with LED 1 x HDD LED 1 x GPIO (8 bits) 1 x Recovery button 1 x 2.5" SSD/HDD SATA Extension	1 x Micro SD card 1 x Micro USB 2.0 (OTD) 1 x HDMI 2.0 1 x Display Port 1 x Power switch with LED 1 x HDD LED 1 x GPIO (8 bits) 1 x Recovery button 1 x 2.5" SSD/HDD SATA Extension
Rear I/O	4 x COM (RS-232/422/485) 1 x DC Jack /Terminal block (Optional) 10 x RJ45 LAN ports 4 x USB 3.2 Gen1x1 2 x Antenna (Optional)	4 x COM (RS-232/422/485) 1 x DC Jack /Terminal block (Optional) 10 x RJ45 LAN ports 4 x USB3.2 Gen1x1 2 x Antenna (Optional)
Power	+12~54VDC (non POE) +54VDC (POE support)	+12~54VDC (non POE) +54VDC (POE support)
Operating Temp.	-20°C to 70°C	-20°C to 70°C
Ordering Information	—	—
Build in Components	—	—

Embedded IoT Series



Model Name	EL-30-4200 (rev. 1.0) EL-30-3350 (rev. 1.0)	EL-20-3710-32G (rev. 1.0) EL-20-3060-32G (rev. 1.0)
Dimension	140.8W x 107.5D x 29.5H (mm)	140.8W x 107.5D x 27H (mm)
CPU	Intel® Pentium® Processor N4200, 14nm, 4 cores, 4 threads, up to 2.5 GHz, TDP 6W (EL-30-4200) Intel® Celeron® Processor N3350, 14nm, 2 cores, 2 threads, up to 2.4 GHz, TDP 6W (EL-30-3350)	Intel® Pentium® processor N3710, 14nm, 4 cores, 4 threads, up to 2.56 GHz, TDP 6 W (EL-20-3710-32G) Intel® Celeron® processor N3060, 14nm, 2cores, 2 threads, up to 2.48 GHz, TDP 6 W (EL-20-3060-32G)
Chipset	FCBGA1296	FCBGA1296
Memory	2 x DDR3L SO-DIMM sockets, Max. Capacity 8 GB, Support Dual Channel DDR3L 1866 MHz	2 x DDR3L SO-DIMM sockets, Max. Capacity 8 GB, Support Dual Channel DDR3L 1600 MHz
Ethernet	2 x GbE LAN Port (Realtek® RTL8111HS)	2 x GbE LAN Port (Realtek® RTL8111HS)
Graphic	EL-30-4200: Integrated Graphics Processor - Intel® HD Graphics 505: 2 x HDMI 1.4 EL-30-3350: Integrated Graphics Processor - Intel® HD Graphics 500: 2 x HDMI 1.4 2 independent display outputs	Integrated Graphics Processor - Intel® HD Graphics 500: 2 x HDMI 1.4 2 independent display outputs
Audio	Realtek® Audio Codec	Realtek® Audio Codec
Storage	1 x eMMC 32GB	1 x eMMC 32GB
Expansion Slots	1 x Full-size Mini PCIe with SIM slot/ mSATA 1 x 2230 M.2 E-Key (Wi-Fi preinstalled) 1 x Zigbee module (Optional)	1 x Full-size Mini PCIe/mSATA 1 x Half-size Mini PCIe
Front I/O	4 x USB 3.0 1 x Micro SD Card Slot 1 x Audio Combo Jack (Headphone & Microphone) 1 x Power Button with LED 1 x HDD LED	4 x USB3.0 1 x Micro SD Card Slot 1 x Audio Combo Jack (Headphone & Microphone) 1 x Power Button with LED 1 x HDD LED 3 x LED reserved for user configuration
Rear I/O	2 x RJ45 LAN ports 2 x HDMI 1 x COM port (RS-232/485)(RJ45 Type) 1 x DC Jack	2 x RJ45 LAN ports 2 x HDMI 1 x DC Jack
Side I/O	1 x COM port (RS-232)(Micro-B 5-pin) 1 x Kensington Lock 4 x External Antenna Hole	1 x USB 2.0 (Micro-B) 1 x COM port (RS-232)(Micro-B 5-pin) 1 x Kensington Lock 3 x External Antenna Hole
TPM	1 x TPM header	1 x TPM header
Power	+12V~19VDC (Adapter 19V/65W)	+12V~19VDC (Adapter 19V/65W)
Operating Temp.	0°C to 40°C	0°C to 40°C
Ordering Information	9BTCV9WMR-SI (Box packing) (EL-30-4200) 9BTCV8WMR-SI (Box packing) (EL-30-3350)	9BTCV5MR-SI (Box packing)(EL-20-3710-32G) 9BTCV7MR-SI (Box packing)(EL-20-3060-32G)
Built-in Components	Memory: 2 x 2GB DDR3L SO-DIMM ZigBee Module MS5168-M03 WiFi/BT Combo module: Intel® AC3168	Memory: 2 x 2GB DDR3L SO-DIMM (EL-20-3710-32G) Memory: 2 x 1GB DDR3L SO-DIMM (EL-20-3060-32G)

QBiX-Plus Series



Model Name	QBiX-Plus-KBLA7100-A1	QBiX-Plus-APLA3450-A1
Dimension	180W x 117D x 36H (mm)	165W x 105D x 27H (mm)
CPU	Intel® Core™ i3-7100U Processor, 14nm, 2 cores, 4 threads, up to 2.40 GHz, TDP 15W	Intel® Celeron® N3450 Processor, 14nm, 4 cores, 4 threads, up to 2.2 GHz, TDP 6W
Chipset	SoC	SoC
Memory	2 x DDR4 SO-DIMM sockets, Max. Capacity 32 GB, Support Dual Channel DDR4 2133 MHz	2 x DDR3L SO-DIMM sockets, Max. Capacity 8 GB, Support Dual Channel DDR3L 1866 MHz
Ethernet	2 x GbE LAN ports (Intel® I219LM and Intel® I210AT)	2 x GbE LAN ports (Realtek® RTL8111HS)
Graphic	Integrated Graphics Processor - Intel® HD Graphics 620: 2 x HDMI 2.0 2 independent display outputs	Integrated Graphics Processor - Intel® HD Graphics 500: 2 x HDMI 1.4 2 independent display outputs
Audio	Realtek® Audio Codec	Realtek® Audio Codec
Storage	—	—
Expansion Slots	1 x 2280 M.2 M-Key (PCIe x4, SATA 6Gb/s) 1 x 2230 M.2 E-Key 1 x Full-size Mini PCIe with SIM slot	1 x 2280 M.2 M-Key (SATA 6Gb/s) 1 x 2230 M.2 E-Key 1 x Full-size Mini PCIe with SIM slot
Front I/O	1 x USB 3.1 Gen2 Type C 1 x USB 3.1 Gen2 Type A 2 x USB 3.0 1 x COM port (RS-232/422/485) 1 x Micro SD card slot 1 x Power button	2 x USB 3.0 1 x COM port (RS-232/422/485)(RJ45 Type) 1 x Micro SD card slot 1 x Power button
Rear I/O	1 x Combo Audio Jack (Microphone & Headphone) 2 x RJ45 LAN ports 2 x USB 3.0 2 x HDMI 1 x DC Jack	1 x Combo Audio Jack (Microphone & Headphone) 2 x RJ45 LAN ports 2 x USB 3.0 2 x HDMI 1 x DC Jack
Side I/O	3 x External Antenna Hole (Optional)	3 x External Antenna Hole (Optional)
TPM	—	—
Power	+19VDC (Adapter 19V/90W)	+19VDC (Adapter 19V/65W)
Operating Temp.	0°C to 40°C	0°C to 50°C
Mounting	VESA 75/100	VESA 75/100
Ordering Information	9BCKABMR-SI (Box packing)	9BCBBAMR-SI (Box packing)
Built-in Components	Memory: 4GB DDR4 SO-DIMM Storage: 128GB M.2 SSD	Memory: 4GB DDR4 SO-DIMM Storage: 128GB M.2 SSD

QBiX-Lite Series

QBiX-Lite Series



QBiX-Lite

Market Name	QBiX-Lite-TGLA	Market Name	QBiX-Lite-AMDA1605H-A1
Dimension	234W x 155D x 30H (mm)	Dimension	234W x 155D x 30H (mm)
CPU	Intel® Core™ Tiger Lake Processor series, TDP 28W	CPU	AMD® RYZEN™ Embedded V1605B, 14nm, 4 cores, 8 threads, up to 3.6GHz, TDP 25W (Thermal Solution with Fan)
Chipset	SoC	Chipset	SoC
Memory	2 x DDR4 SO-DIMM sockets, Max. Capacity 32 GB, Support Dual Channel DDR4 2933 MHz	Memory	2 x DDR4 SO-DIMM sockets, Max. Capacity 32 GB, Support Dual Channel DDR4 2400 MHz
Ethernet	2 x GbE LAN ports (Intel® I219V and Intel® I211AT)	Ethernet	2 x GbE LAN port (Realtek® RTL8111HS)
Graphic	Integrated Graphics Processor - Intel® Iris X ^e Graphics 2 x HDMI 2.0, 2 x DP 1.4 4 independent display outputs	Graphic	Integrated Graphics Processor - AMD® Radeon™ Vega 8 Graphics: 4 x HDMI 2.0 4 independent display outputs EDID Emulation support with AMD utility
Audio	Realtek® Audio Codec	Audio	Realtek® Audio Codec
Storage	—	Storage	1 x 2.5" HDD/SSD Drive (Optional kit)
Expansion Slots	1 x 2280 M.2 M-Key (PCIe x2, SATA 6Gb/s) 1 x 2230 M.2 E-Key 1 x 3052 M.2 B-Key with SIM Slot (Support 5G)	Expansion Slots	1 x 2280 M.2 M-Key (PCIe x4, SATA 6Gb/s) 1 x 2230 M.2 E-Key 1 x Full-size miniPCIe with SIM slot
Front I/O	2 x RJ45 LAN ports 4 x USB3.2 Gen2x1 Gen2 2 x USB2.0 2 x HDMI 2 x Display port 1 x Power button with LED 1 x USB type C (USB3.2 Gen2x1+ DP output-share with DP) & PD Out -100W 1 x USB type C (USB3.2 Gen2x1 Gen2, PD input-100W) 1 x SATA LED	Front I/O	2 x RJ45 LAN ports 2 x USB 3.0 2 x USB 2.0 4 x HDMI 1 x Power button with LED 1 x HDD LED 1 x Line out Phone Jack 1 x Screw Type DC Jack
Rear I/O	1 x COM (RS-232) 2 x USB 2.0 1 x Line out	Rear I/O	1 x COM (RS-232/422/485 & RI/5V/12V) 2 x USB 2.0 2 x External Antenna Hole (Optional)
Side I/O	4 x External Antenna Hole (Optional)	Side I/O	—
TPM	—	TPM	Onboard TPM 2.0 security chip INFINEON SLB9665TT2.0
Power	+12V~24VDC	Power	+9V~36VDC (Adapter 19V/65W)
Operating Temp.	0°C to 50°C	Operating Temp.	0°C to 50°C
Mounting	Wall mount (Default) VESA75/100 (Optional)	Mounting	Wall mount (Default) VESA75/100 (Optional)
Ordering Information	—	Ordering Information	6BQL1605AMR-SI (Box packing)
Built-in COM portponents	—	Built-in COM portponents	—

QBiX-Lite Series



Market Name	QBiX-Lite SDM Kits
Dimension	195W x 158D x 30H (mm)
CPU	Support SDM module as follows. SDM-7300L –Intel vPro support SDM-7100L SDM-4000L SDM-3350L-QV SDM-3350L-HW
Chipset	—
Memory	Depends SDM module
Ethernet	Depends SDM module
Graphic	1 x HDMI port, supporting a maximum resolution depends on SDM module 1 x DP port: max. resolution depends on SDM module
Audio	Intel® Integrated Audio
Storage	1 x eMMC 32GB (SDM-4000L) 1 x SATA 6Gb/s
Expansion Slots	1 x 2280 M.2 M-Key (SATA 6Gb/s) 1 x 2230 M.2 E-Key 1 x Full-size mini PCIe (PCIe only)
Front I/O	1 x Display Port 1 x RJ45 LAN port 4 x USB 3.0 1 x Power/ HDD LED 2 x External Antenna Hole (Optional) 1 x Reset button 1 x Power button
Rear I/O	1 x USB 3.0 1 x Display Port (Co-lay with front Display port) 1 x HDMI 1 x UART 1 x DC-Jack 1 x 2x2 Power connector
Side I/O	—
TPM	—
Power	+12V~24VDC
Operating Temp.	0°C to 50°C
Mounting	Wall mount, VESA75/100 (Optional)
Ordering Information	6BSD4000AMR-SI (Box packing)
Built-in COM portponents	—

SDM-L Series



SDM-L Series

Model Name	SDM-1135G7L SDM-1115G4L	SDM-7300L SDM-7100L	SDM-4000L
Dimensions	SDM-Large, 175W x 100D (mm)	SDM-Large, 175W x 100D (mm)	SDM-Large, 175W x 100D (mm)
CPU	Intel® Core™ i5-1135G7 Processor , 8M Cache, up to 4.20 GHz Intel® Core™ i3-1115G4 Processor , 6M Cache, up to 4.10 GHz	Intel® Core™ i5-7300U Processor, 14nm, 2 cores, 4 threads, up to 3.5 GHz, TDP 15W, vPro support (SDM-7300L) Intel® Core™ i3-7100U Processor, 14nm, 2 cores, 4 threads, up to 2.40 GHz, TDP 15W (SDM-7100L)	Intel® Celeron® N4000 Processor, 14nm, 2 Cores, 2 threads, up to 2.6 GHz, TDP 6W
VPro	—	Intel® vPro™ Platform Eligibility (SDM-7300L)	—
Memory	2 x DDR4 SO-DIMM sockets, Max. Capacity 32 GB, Support Dual Channel DDR4 2933 MHz	2 x DDR4 SO-DIMM sockets, Max. Capacity 32 GB, Support Dual Channel DDR4 2133 MHz	2 x DDR4 SO-DIMM sockets, Max. Capacity 8 GB, Support Dual Channel DDR4 2400 MHz
Ethernet	1 x GbE LAN port (Intel® I219V)	1 x GbE LAN port (7300L: Intel® I219LM) (7100L: Intel® I219V)	1 x GbE LAN port (Realtek® RTL8111HS)
Graphic	Integrated Graphics Processor - Intel® Iris Xe Graphics: 1 x HDMI 2.0 (SDM), 2 x HDMI 2.0 (Rear), 1 x DisplayPort (SDM) 4 independent display outputs	Integrated Graphics Processor - Intel® HD Graphics 620: 1 x HDMI 2.0 (SDM), 1 x Display Port (Rear/SDM) 2 independent display outputs	Integrated Graphics Processor - Intel® UHD Graphics 600: 1 x HDMI 2.0 (SDM), 1 x Display Port (Rear/SDM) 2 independent display outputs
Audio	Intel® Integrated Audio	Intel® Integrated Audio	Intel® Integrated Audio
Storage	—	—	1 x eMMC 32GB
Expansion Slots	1 x 2280 M.2 M-Key (PCIe x4, SATA 6Gb/s) 1 x 2230 M.2 E-Key	1 x 2280 M.2 M-Key (PCIe x4, SATA 6Gb/s) 1 x 2230 M.2 E-Key	1 x 2280 M.2 M-Key (SATA 6Gb/s) 1 x 2230 M.2 E-Key
Internal I/O	—	—	—
Rear I/O	1 x Display Port 2 x HDMI 1 x RJ45 LAN port 3 x USB 3.2 Gen1x1 1 x USB 2.0 1 x Power/ HDD LED 2 x External Antenna Hole (Optional) 1 x Reset button 1 x Power button	1 x Display Port 1 x RJ45 LAN port 4 x USB 3.0 1 x Power/ HDD LED 2 x External Antenna Holes (Optional) 1 x Reset button 1 x Power button	1 x Display Port 1 x RJ45 LAN port 4 x USB 3.0 1 x Power/ HDD LED 2 x External Antenna Holes (Optional) 1 x Reset button 1 x Power button
TPM	1 x TPM header	1 x TPM header	—
Operating Temp.	0°C to 55°C	0°C to 55°C	0°C to 55°C
Ordering Information	9MTGU5ALMR-SI (Box packing) (SDM-1135G7L)	9MFLP5ALMR-SI (Box packing) (SDM-7300L) 9MFLP3ALMR-SI (Box packing) (SDM-7100L)	9MZGLKALMR-SI (Box packing)
Built-in Components	—	—	—

SDM-L Series



Model Name	SDM-3350L-QV	SDM-3350L-HW	SDM Docking Board
Dimensions	SDM-Large, 175W x 100D (mm)	SDM-Large, 175W x 100D (mm)	190W x 62D (mm)
CPU	Intel® Celeron® N3350 Processor, 14nm, 2 cores, 2 threads, up to 2.4 GHz, TDP 6W	Intel® Celeron® N4000 Processor, 14nm, 2 Cores, 2 threads, up to 2.6 GHz, TDP 6W	—
VPro	—	—	—
Memory	2 x DDR3L SO-DIMM sockets, Max. Capacity 8 GB, Support Dual Channel DDR3L 1866 MHz	2 x DDR4 SO-DIMM sockets, Max. Capacity 8 GB, Support Dual Channel DDR4 2400 MHz	—
Ethernet	1 x GbE LAN port (Realtek® RTL8111HS)	1 x GbE LAN port (Realtek® RTL8111HS)	—
Graphic	Integrated Graphics Processor - Intel® HD Graphics 500: 1 x HDMI 1.4 (SDM), 2 x Display Port (Rear/SDM) 3 independent display outputs (Full HD)	Integrated Graphics Processor - Intel® UHD Graphics 600: 1 x HDMI 2.0 (SDM), 1 x Display Port (Rear/SDM) 2 independent display outputs	—
Audio	Intel® Integrated Audio	Intel® Integrated Audio	—
Storage	1 x eMMC 32GB	1 x eMMC 32GB	—
Expansion Slots	1 x 2280 M.2 M-Key (SATA 6Gb/s) 1 x 2230 M.2 E-Key	1 x 2280 M.2 M-Key (SATA 6Gb/s) 1 x 2230 M.2 E-Key	1 x PCIe x8 slot for SDM-L module 1 x Full-size mini PCIe (PCIe only)
Internal I/O	—	—	2 x I2C 1 x GPIO 1 x COM (TX, RX only)
Rear I/O	1 x Display Port 1 x RJ45 LAN port 4 x USB 3.0 1 x Power/ HDD LED 2 x External Antenna Holes (Optional) 1 x Reset button 1 x Power button	1 x Display Port 1 x RJ45 LAN port 4 x USB 3.0 1 x Power/ HDD LED 2 x External Antenna Holes (Optional) 1 x Reset button 1 x Power button	1 x USB 3.0 1 x Display Port 1 x HDMI 1 x UART 1 x DC-Jack 1 x 2x2 Power connector
TPM	—	—	—
Operating Temp.	0°C to 55°C	0°C to 55°C	0°C to 60°C
Ordering Information	9MAPLKALMR-SI (Box packing)	9MAPLKBLMR-HW (Box packing)	—
Built-in Components	—	—	—



Smart Whiteboard Collaboration without Limits

Smart Whiteboard

Nowadays, video conferences have become the new norm in the corporate world. For which devices that allow smooth collaboration within the colleagues inside the same meeting room, or in another continent, have become more and more important.

Smart whiteboards are one of those devices that allow collaboration among colleagues, enhance brainstorming for new ideas, and encourage creativity. With the Smart Whiteboard, forget about the restrictions of cables and physical space, and explore ideas without limit.

GIGAIPC has made the perfect integration of Intel® Smart Display Module (Intel® SDM) Solution with a high-quality touch screen of 55", 65", 75" and the OS to create a smooth user-friendly Smart Whiteboard solution, that needs just to plug in and play. Even the most traditional colleague will be able to interact with the whiteboard right away.

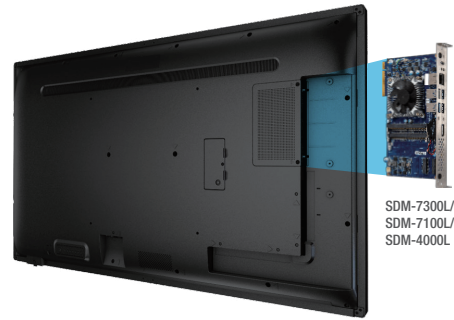

SDM-7300L/
SDM-7100L/
SDM-4000L

Collaboration Without Borders

With Smart Whiteboard you will not only have a beautiful display to present your latest report, but you will have a powerful computing machine to allow you enrich your presentations with latest digital media, and most importantly connect to the internet and present to everyone in your corporation around the world and inside your office. Allowing them to participate and comment on your presentation in real-time: Asking the right questions at the right time has never been easier than with the Smart Whiteboard.

Upgrade Your Team's Creativity

Have you ever been in a brainstorming session, that has been restricted because there is not enough space in the whiteboard? Well, that is now a thing of the past with a smart whiteboard. With its unlimited canvas, you can all brainstorm together by drawing, handwriting, inserting graphs, tables, or images on the same canvas at the same time. Even if you are not in the same meeting room or the same country. People can simultaneously access files, edit contents, annotate, save and share documents through this smartboard to finish the brainstorming process effectively.

4K-UHD Resolution		Narrow Bezel Black Metal
Contrast Ratio: 1200:1		Display Size: 55"/ 65"/ 75"
Display Resolution: 3840 x 2160 Aspect Ratio		Viewing Angel: H:175°/ V:175°
Highly Responsive Touch Screen		Aspect Ratio: 16:9
Support up to 20-point Touch		Brightness: 440 cd/m ²



Quick Deployment

Smart Digital Module (SDM) is pre-installed with Windows. It is inserted in the touch panel and ready to use.



Economic Feasibility

Easy to upgrade by switching new version of SDM. It's not necessary to replace the whole solution to save high costs.



Massive Device Collaboration

Users connect Smart Whiteboard to desktop, notebook or even smart devices, such as IOS and Android with a single application.



Multi-User Capability

Users access files and edit contents, handwriting and graphics at the same time when they are in different physical places.



Real-Time Interaction

Suitable for Online-to-Offline meetings with audio and video peripherals connected.

Smart Whiteboard Series

SDM Display Product Photo		
SDM-L Photo		
Market Name	GSW-A55S7300-A1 GSW-A55S7100-A1	GSW-A55S4000-A1
Dimension	1271.7W x 742.6D x 74.66D (mm)	1271.7W x 742.6H x 74.66D (mm)
Display Size	55"	55"
Brightness	430 cd/m2	430 cd/m2
Contrast Ratio	1200:1	1200:1
Viewing Angel	H:175°/ V:175°	H:175°/ V:175°
Display Resolution	3840 x 2160 (16:9)	3840 x 2160 (16:9)
Touch technology	IR, 20 points	IR, 20 points
Speaker	10W x 2	10W x 2
CPU	Intel® Core™ i5-7300U Processor , 14nm, 2 cores, 4 threads, up to 3.5 GHz, TDP 15W Intel® Core™ i3-7100U Processor , 14nm, 2 cores, 4 threads, 2.40 GHz, TDP 15W	Intel® Celeron® N4000 Processor, 14nm, 2 Cores, 2 threads, up to 2.6 GHz, TDP 6W
vPro	Intel® vPro™ Platform Eligility (with i5-7300U)	—
Memory	2 x DDR4 SO-DIMM sockets, Max. Capacity 32 GB, Support Dual Channel DDR4 2133 MHz	2 x DDR4 SO-DIMM sockets, Max. Capacity 8 GB, Support Dual Channel DDR4 2400 MHz
Ethernet	1 x GbE LAN port (7300: Intel® I219LM) (7200/7100: Intel® I219V)	1 x GbE LAN port (Realtek® RTL8111HS)
Graphic	Integrated Graphics Processor - Intel® HD Graphics 620: 1 x HDMI 2.0 (SDM), 1 x Display Port (Rear/SDM) 2 independent display outputs	Integrated Graphics Processor - Intel® UHD Graphics 600: 1 x HDMI 2.0 (SDM), 1 x Display Port (Rear/SDM) 2 independent display outputs
Audio	Intel® Integrated Audio	Intel® Integrated Audio
Storage	—	1 x eMMC 32GB
Expansion Slots	1 x 2280 M.2 M-Key (PCIe x4, SATA 6Gb/s) 1 x 2230 M.2 E-Key	1 x 2280 M.2 M-Key (SATA 6Gb/s) 1 x 2230 M.2 E-Key
SDM I/O	1 x Display Port 1 x RJ45 LAN port 4 x USB 3.0 1 x Power/ HDD LED 2 x External Antenna Hole (Optional) 1 x Reset button 1 x Power button	1 x Display Port 1 x RJ45 LAN port 4 x USB 3.0 1 x Power/ HDD LED 2 x External Antenna Hole (Optional) 1 x Reset button 1 x Power button
TPM	1 x TPM header	—
Dispy I/O	2 x HDMI 2.0 1 x Display Port 1.2 1 x DVI-D 1 x VGA 1 x PC Audio In 1 x SPDIF Out 1 x HDMI 2.0 Output (Duplicate mode support) 1 x RS-232 1 x USB 2.0 Type B (USB Touch Bypass)	2 x HDMI 2.0 1 x Display Port 1.2 1 x DVI-D 1 x VGA 1 x PC Audio In 1 x SPDIF Out 1 x HDMI 2.0 Output (Duplicate mode support) 1 x RS-232 1 x USB 2.0 Type B (USB Touch Bypass)
Mounting	400 x 400 (mm)	400 x 400 (mm)
Power	AC 100V ~ 240V	AC 100V ~ 240V
Operating Temp.	0°C to 40°C	0°C to 40°C
Ordering Information	—	—
Built-in COM portponents	Memory: 16GB DDR4 SO-DIMM Storage: 256GB M.2 SSD	Memory: 8GB DDR4 SO-DIMM Storage: 256GB M.2 SSD

Smart Whiteboard Series

SDM Display Product Photo		
SDM-L Photo		
Market Name	GSW-A65S7300-A1 GSW-A65S7100-A1	GSW-A65S4000-A1
Dimension	1494.3W x 907.4H x 80.2D (mm)	1494.3W x 907.4H x 80.2D (mm)
Display Size	65"	65"
Brightness	430 cd/m2	430 cd/m2
Contrast Ratio	1200:1	1200:1
Viewing Angel	H:175°/ V:175°	H:175°/ V:175°
Display Resolution	3840 x 2160 (16:9)	3840 x 2160 (16:9)
Touch technology	IR, 20 points	IR, 20 points
Speaker	15W x 2	15W x 2
CPU	Intel® Core™ i5-7300U Processor , 14nm, 2 cores, 4 threads, up to 3.5 GHz, TDP 15W Intel® Core™ i3-7100U Processor , 14nm, 2 cores, 4 threads, 2.40 GHz, TDP 15W	Intel® Celeron® N4000 Processor, 14nm, 2 Cores, 2 threads, up to 2.6 GHz, TDP 6W
vPro	Intel® vPro™ Platform Eligibility (with i5-7300U)	—
Memory	2 x DDR4 SO-DIMM sockets, Max. Capacity 32 GB, Support Dual Channel DDR4 2133 MHz	2 x DDR4 SO-DIMM sockets, Max. Capacity 8 GB, Support Dual Channel DDR4 2400 MHz
Ethernet	1 x GbE LAN port (7300: Intel® I219LM) (7200/7100: Intel® I219V)	1 x GbE LAN port (Realtek® RTL8111HS)
Graphic	Integrated Graphics Processor - Intel® HD Graphics 620: 1 x HDMI 2.0 (SDM), 1 x Display Port (Rear/SDM) 2 independent display outputs	Integrated Graphics Processor - Intel® UHD Graphics 600: 1 x HDMI 2.0 (SDM), 1 x Display Port (Rear/SDM) 2 independent display outputs
Audio	Intel® Integrated Audio	Intel® Integrated Audio
Storage	—	1 x eMMC 32GB
Expansion Slots	1 x 2280 M.2 M-Key (PCIe x4, SATA 6Gb/s) 1 x 2230 M.2 E-Key	1 x 2280 M.2 M-Key (SATA 6Gb/s) 1 x 2230 M.2 E-Key
SDM I/O	1 x Display Port 1 x RJ45 LAN port 4 x USB 3.0 1 x Power/ HDD LED 2 x External Antenna Hole (Optional) 1 x Reset button 1 x Power button	1 x Display Port 1 x RJ45 LAN port 4 x USB 3.0 1 x Power/ HDD LED 2 x External Antenna Hole (Optional) 1 x Reset button 1 x Power button
TPM	1 x TPM header	—
Dispy I/O	2 x HDMI 2.0, 1 x Display Port 1.2 1 x DVI-D 1 x VGA 1 x PC Audio In 1 x SPDIF Out 1 x HDMI 2.0 Output (Duplicate mode support) 1 x RS-232 1 x USB 2.0 Type B (USB Touch Bypass)	2 x HDMI 2.0, 1 x Display Port 1.2 1 x DVI-D 1 x VGA 1 x PC Audio In 1 x SPDIF Out 1 x HDMI 2.0 Output (Duplicate mode support) 1 x RS-232 1 x USB 2.0 Type B (USB Touch Bypass)
Mounting	400 x 400 (mm)	400 x 400 (mm)
Power	AC 100V ~ 240V	AC 100V ~ 240V
Operating Temp.	0°C to 40°C	0°C to 40°C
Ordering Information	—	—
Built-in COM portponents	Memory: 16GB DDR4 SO-DIMM Storage: 256GB M.2 SSD	Memory: 8GB DDR4 SO-DIMM Storage: 256GB M.2 SSD

Smart Whiteboard Series

SDM Display Product Photo		
SDM-L Photo		
Market Name	GSW-A75S7300-A1 GSW-A75S7100-A1	GSW-A75S4000-A1
Dimension	1715.5W x 1031.7H x 80.8D (mm)	1715.5W x 1031.7H x 80.8D (mm)
Display Size	75"	75"
Brightness	430 cd/m2	430 cd/m2
Contrast Ratio	1200:1	1200:1
Viewing Angel	H:175°/ V:175°	H:175°/ V:175°
Display Resolution	3840 x 2160 (16:9)	3840 x 2160 (16:9)
Touch technology	IR, 20 points	IR, 20 points
Speaker	15W x 2	15W x 2
CPU	Intel® Core™ i5-7300U Processor , 14nm, 2 cores, 4 threads, up to 3.5 GHz, TDP 15W Intel® Core™ i3-7100U Processor , 14nm, 2 cores, 4 threads, 2.40 GHz, TDP 15W	Intel® Celeron® N4000 Processor, 14nm, 2 Cores, 2 threads, up to 2.6 GHz, TDP 6W
vPro	Intel® vPro™ Platform Eligibility (with i5-7300U)	—
Memory	2 x DDR4 SO-DIMM sockets, Max. Capacity 32 GB, Support Dual Channel DDR4 2133 MHz	2 x DDR4 SO-DIMM sockets, Max. Capacity 8 GB, Support Dual Channel DDR4 2400 MHz
Ethernet	1 x GbE LAN port (7300: Intel® I219LM) (7200/7100: Intel® I219V)	1 x GbE LAN port (Realtek® RTL8111HS)
Graphic	Integrated Graphics Processor - Intel® HD Graphics 620: 1 x HDMI 2.0 (SDM), 1 x Display Port (Rear/SDM) 2 independent display outputs	Integrated Graphics Processor - Intel® UHD Graphics 600: 1 x HDMI 2.0 (SDM), 1 x Display Port (Rear/SDM) 2 independent display outputs
Audio	Intel® Integrated Audio	Intel® Integrated Audio
Storage	—	1 x eMMC 32GB
Expansion Slots	1 x 2280 M.2 M-Key (PCIe x4, SATA 6Gb/s) 1 x 2230 M.2 E-Key	1 x 2280 M.2 M-Key (SATA 6Gb/s) 1 x 2230 M.2 E-Key
SDM I/O	1 x Display Port 1 x RJ45 LAN port 4 x USB 3.0 1 x Power/ HDD LED 2 x External Antenna Hole (Optional) 1 x Reset button 1 x Power button	1 x Display Port 1 x RJ45 LAN port 4 x USB 3.0 1 x Power/ HDD LED 2 x External Antenna Hole (Optional) 1 x Reset button 1 x Power button
TPM	1 x TPM header	—
Dispy I/O	2 x HDMI 2.0, 1 x Display Port 1.2 1 x DVI-D 1 x VGA 1 x PC Audio In 1 x SPIDIF Out 1 x HDMI 2.0 Output (Duplicate mode support) 1 x RS-232 1 x USB 2.0 Type B (USB Touch Bypass)	2 x HDMI 2.0, 1 x Display Port 1.2 1 x DVI-D 1 x VGA 1 x PC Audio In 1 x SPIDIF Out 1 x HDMI 2.0 Output (Duplicate mode support) 1 x RS-232 1 x USB 2.0 Type B (USB Touch Bypass)
Mounting	600 x 400 (mm)	600 x 400 (mm)
Power	AC 100V ~ 240V	AC 100V ~ 240V
Operating Temp.	0°C to 40°C	0°C to 40°C
Ordering Information	—	—
Built-in COM portponents	Memory: 16GB DDR4 SO-DIMM Storage: 256GB M.2 SSD	Memory: 8GB DDR4 SO-DIMM Storage: 256GB M.2 SSD

Micro-ATX Series

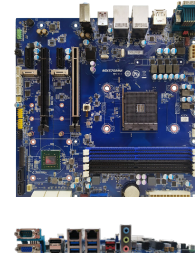

Micro-ATX Series

Model Name	uATX-Q47EA	uATX-H410A	uATX-X570A
CPU	Support for 10th Generation Intel® Core™ i9/i7/i5/i3, Pentium® & Celeron® processors, TDP under 95W	Support for 10th Generation Intel® Core™ i7/i5/i3, Pentium® & Celeron® processors, TDP under 65W	Supports 3rd Generation AMD Ryzen™ processors/ 2nd Generation AMD Ryzen™ processors/ 2nd Generation AMD Ryzen™ with Radeon™ Vega Graphics processors
Socket	LGA 1200	LGA 1200	Socket AM4
Chipset	Intel® Q470E Chipset	Intel® H410 Chipset	AMD® X570
Memory	4 x DDR4 DIMM sockets, Max. Capacity 128 GB, Support Dual Channel DDR4 2933MHz	2 x DDR4 DIMM sockets, Max. Capacity 64 GB, Support Dual Channel DDR4 2933MHz	4 x DDR4 DIMM sockets, Max. Capacity up to 128GB, Support Dual Channel DDR4
Ethernet	4 x GbE LAN port (Intel® I219LM and Intel® I211AT)	2 x GbE LAN port (Intel® I219V and Realtek® RTL8111HS)	2 x GbE LAN ports (Realtek® RTL8111HS)
Graphic	Integrated Graphics Processor - 1 x HDMI 1.4, 1 x DP, 1 x VGA, 1 x LVDS 3 independent display outputs	Integrated Graphics Processor - 1 x HDMI 1.4, 1 x DVI-D, 1 x VGA 2 independent display outputs	1 x HDMI 2.0 1 x DP++ 1.2, 1 x VGA 3 independent display outputs
Audio	Realtek® Audio Codec	Realtek® Audio Codec	Realtek® Audio Codec
Storage	4 x SATA 6Gb/s ports (RAID 0/1/5/10)	4 x SATA 6Gb/s ports	8 x SATA 6Gb/s ports
Expansion Slots	2 x PCIe x16 (2 x Gen3 x8) / (1 x Gen3 x16-optional) 1 x PCIe x4 (Gen3 x4) 1 x PCIe x1 (Gen3 x1) 1 x 2230 M.2 E-Key (PCIe x1 + USB2.0) 1 x 2280/2242 M.2 M-Key (PCIe x4, SATA 6Gb/s)	1 x PCIe x16 (Gen3 x16) - CPU 1 x PCIe x4 (Gen3 x2) 2 x PCIe x1 (Gen3 x1)	1 x PCIe x16 (Gen4 – depends on CPU) 1 x PCIe x4 (Gen4 – depends on CPU) 2 x PCIe x1 (Gen4 – depends on CPU) 1 x 2280/2242 M.2 M-Key (PCIe x4) 1 x 2280/2242 M.2 M-Key (PCIe x4, SATA 6Gb/s)
Internal I/O	1 x 24-pin ATX main power connector 1 x 8-pin ATX 12V power connector 1 x CPU fan header 1 x System fan header 1 x Front panel audio header 1 x VGA header 1 x Backlight control header 1 x AT/ATX mode select jumpers 1 x Front panel header 4 x USB 2.0 headers 1 x COM headers (RS-232/422/485 & RI/5V/12V) 1 x COM headers (RS-232 & RI/5V/12V) 2 x COM headers (RS-232) 1 x nGPIO (8 bits) & SMBUS header 1 x Clear CMOS jumper 1 x Buzzer 1 x Speaker out header	1 x 24-pin ATX main power connector 1 x 8-pin ATX 12V power connector 1 x CPU fan header 2 x System fan headers 1 x Front panel header 1 x Front panel audio header 4 x USB 2.0 headers 3 x COM headers (RS-232) 1 x Clear CMOS jumper 1 x Buzzer	1 x 24-pin ATX main power connector 1 x 8-pin ATX power connector 1 x CPU fan header 2 x System fan headers 1 x Front panel header 1 x Front audio header 4 x USB 2.0 headers 2 x USB3.2 Gen1x1 headers 3 x COM headers (RS-232) 1 x BMC connector 1 x SPI connector 1 x Clear CMOS jumper 1 x Buzzer
Rear I/O	1 x HDMI 1 x Display Port 4 x RJ45 LAN ports 8 x USB 3.0 4 x USB 2.0	3 x Audio Jacks (Line in, Line out, Mic in) 1 x COM port (RS-232) 1 x HDMI 1 x DVI-D 1 x VGA 2 x RJ45 LAN port 4 x USB 3.0	3 x Audio Jacks (Line in, Line out, Mic in) 1 x COM (RS-232/422/485) 1 x HDMI v2.0 1 x Display Port (DP++) v1.2 1 x VGA 2 x RJ45 LAN ports 4 x USB 3.2 Gen1x1 1 x USB 3.2 Gen2x1 Gen2 1 x USB 3.2 Gen2x1 Gen2 (Type C)
TPM	1 x TPM header	Onboard TPM 2.0 security chip INFINEON SLB9665VQ2.0	Onboard TPM 2.0 security chip INFINEON SLB9670VQ2.0 (Option)
Operating Temp.	0°C to 60°C	0°C to 60°C	0°C to 60°C
Ordering Information	9MQ47EAMNR-SI (Bulk packing)	9MH410AMNR-SI (Bulk packing)	—

Micro-ATX Series



Model Name	uATX-Q370A	uATX-H370A	uATX-H310A
CPU	Support for 8th/9th Generation Intel® Core™ i7/i5/i3, Pentium® & Celeron® processors, TDP under 95W	Support for 8th/9th Generation Intel® Core™ i7/i5/i3, Pentium® & Celeron® processors, TDP under 65W	Support for 8th/9th Generation Intel® Core™ i7/i5/i3, Pentium® & Celeron® processors, TDP under 65W
Socket	LGA 1151	LGA 1151	LGA 1151
Chipset	Intel® Q370 Chipset	Intel® H370 Chipset	Intel® H310 Chipset
Memory	4 x DDR4 DIMM sockets, Max. Capacity 64 GB, Support Dual Channel DDR4 2666/2400 MHz	4 x DDR4 DIMM sockets, Max. Capacity 64 GB, Support Dual Channel DDR4 2666/2400 MHz	2 x DDR4 DIMM sockets, Max. Capacity 32 GB, Support Dual Channel DDR4 2666/2400 MHz
Ethernet	2 x GbE LAN port (Intel® I219V and Realtek® RTL8111HS)	2 x GbE LAN port (Intel® I219V and Realtek® RTL8111HS)	2 x GbE LAN port (Intel® I219V and Realtek® RTL8111HS)
Graphic	Integrated Graphics Processor - depends on CPU: 1 x HDMI 1.4 1 x DVI-D 1 x VGA 3 independent display outputs	Integrated Graphics Processor - depends on CPU: 1 x HDMI 1.4 1 x DVI-D 1 x VGA 3 independent display outputs	Integrated Graphics Processor - depends on CPU: 1 x HDMI 1.4 1 x DVI-D 1 x VGA 2 independent display outputs
Audio	Realtek® Audio Codec	Realtek® Audio Codec	Realtek® Audio Codec
Storage	6 x SATA 6Gb/s ports (RAID 0/1/5/10)	6 x SATA 6Gb/s ports (RAID 0/1/5/10)	4 x SATA 6Gb/s ports
Expansion Slots	1 x PCIe x16 (Gen3 x16) 1 x PCIe x4 (Gen3 x4) 2 x PCIe x1 (Gen3 x1) 1 x 2280/2260 M.2 M-Key (PCIe x4)	1 x PCIe x16 (Gen3 x16) 1 x PCIe x4 (Gen3 x4) 2 x PCIe x1 (Gen3 x1) 1 x 2280/2260 M.2 M-Key (PCIe x4)	1 x PCIe x16 (Gen3 x16) 1 x PCIe x4 (Gen2 x2) 2 x PCIe x1 (Gen2 x1)
Internal I/O	1 x 24-pin ATX main power connector 1 x 8-pin ATX 12V power connector 1 x CPU fan header 2 x System fan headers 1 x Front panel header 1 x Front panel audio header 4 x USB 2.0 headers 2 x USB 3.0 headers 3 x COM headers (RS-232) 1 x Clear CMOS jumper 1 x Buzzer	1 x 24-pin ATX main power connector 1 x 8-pin ATX 12V power connector 1 x CPU fan header 2 x System fan headers 1 x Front panel header 1 x Front panel audio header 4 x USB 2.0 headers 2 x USB 3.0 headers 3 x COM headers (RS-232) 1 x Clear CMOS jumper 1 x Buzzer	1 x 24-pin ATX main power connector 1 x 8-pin ATX 12V power connector 1 x CPU fan header 2 x System fan headers 1 x Front panel header 1 x Front panel audio header 4 x USB 2.0 headers 3 x COM headers (RS-232) 1 x Clear CMOS jumper 1 x Buzzer
Rear I/O	3 x Audio Jacks (Line in, Line out, Mic in) 1 x COM port (RS-232) 1 x HDMI 1 x DVI-D 1 x VGA 2 x RJ45 LAN port 3 x USB 3.0 1 x USB 3.1 Gen2	3 x Audio Jacks (Line in, Line out, Mic in) 1 x COM port (RS-232) 1 x HDMI 1 x DVI-D 1 x VGA 2 x RJ45 LAN ports 3 x USB 3.0 1 x USB 3.1 Gen2	3 x Audio Jacks (Line in, Line out, Mic in) 1 x COM port (RS-232) 1 x HDMI 1 x DVI-D 1 x VGA 2 x RJ45 LAN ports 4 x USB 3.0
TPM	Onboard TPM 2.0 security chip INFINEON SLB9665VQ2.0	Onboard TPM 2.0 security chip INFINEON SLB9665VQ2.0	Onboard TPM 2.0 security chip INFINEON SLB9665VQ2.0
Operating Temp.	0°C to 60°C	0°C to 60°C	0°C to 60°C
Ordering Information	9MQ370AMNR-SI (Bulk packing)	9MCH37AMNR-SI (Bulk packing)	9MCH31AMNR-SI (Bulk packing)

Micro-ATX Series

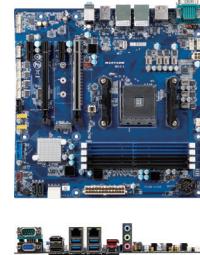
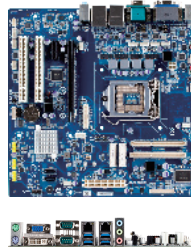

Micro-ATX Series/ Mini-ITX Series

Model Name	uATX-H110A	uATX-H81A	uATX-RYZEN
CPU	Supports for 6/7th Generation Intel® Core™ i7/i5/i3, Pentium® & Celeron® processors, TDP under 65W	Supports for 4th Generation Intel® Core™ i7/i5/i3, Pentium® & Celeron® processors, TDP under 85W	Supports AMD® RYZEN™ 2 7'5'3 CPU AM4 μPGA (Matisse/ Picasso/ Raven2/ Pinnacle/ Raven/Summit Ridge), TDP under 65W
Socket	LGA 1151	LGA 1150	Socket AM4
Chipset	Intel® H110 Chipset	Intel® H81 Chipset	AMD® B450
Memory	2 x DDR4 DIMM sockets, Max. Capacity 32 GB, Support Dual Channel DDR4 2400/2133 MHz	2 x DDR3 SO-DIMM slots, Max. Capacity 16 GB, Support Dual Channel DDR3 1600/1333 MHz	4 x DDR4 DIMM sockets, Max. Capacity 64 GB, Support Dual Channel DDR4 2666/2400/2133 MHz
Ethernet	2 x GbE LAN port (Intel® I219LM and Realtek® RTL8111HS)	2 x GbE LAN ports (Realtek® RTL8111G)	2 x GbE LAN ports (Realtek® RTL8111HS)
Graphic	Integrated Graphics Processor - depends on CPU: 1 x HDMI 1.4, 1 x DVI-D, 1 x VGA 2 independent display outputs	Integrated Graphics Processor - depends on CPU: 1 x DVI-D, 1 x VGA, 1 x LVDS 2 independent display outputs	Integrated Graphics Processor - Radeon™ Vega 11/ 8/ 3/ Graphics 1 x HDMI 1.4, 1 x Disply Port, 1 x VGA 3 independent display outputs
Audio	Realtek® Audio Codec	Realtek® Audio Codec	Realtek® Audio Codec
Storage	4 x SATA 6Gb/s ports	2 x SATA 3Gb/s ports	4 x SATA 6Gb/s ports (RAID 0/1/10)
Expansion Slots	1 x PCIe x16 (Gen3 x16) 1 x PCIe x4 (Gen2 x2) 2 x PCIe x1 (Gen2 x1)	1 x PCIe x16 (Gen3 x16) 1 x PCIe x1 (Gen2 x1) 2 x PCI 1 x Half-size Mini PCIe 1 x Full-size Mini PCIe	1 x PCIe x16 (Gen3 x16) 1 x PCIe x4 (Gen2 x2) 2 x PCIe x1 (Gen2 x1) 1 x 22110/2280/2260/2242 M.2 M-Key (PCIe x4, SATA 6Gb/s)
Internal I/O	1 x 24-pin ATX main power connector 1 x 8-pin ATX 12V power connector 1 x CPU fan header 2 x System fan headers 1 x Front panel header 1 x Front panel audio header 2 x USB 2.0 headers 3 x COM headers (RS-232) 1 x Clear CMOS jumper 1 x Buzzer	1 x 24-pin ATX main power connector 1 x 4-pin ATX 12V power connector 1 x CPU fan header 2 x System fan headers 1 x Front panel header 1 x Front audio header 1 x 2W Speaker out header 6 x USB 2.0 headers 6 x COM headers (RS-232) 2 x COM headers (RS-232 & RI/5V/12V) 1 x LPC 1 x LPT 1 x GPIO (8 bits) & SMBUS header 1 x Clear CMOS jumper 1 x Buzzer	1 x 24-pin ATX main power connector 1 x 4-pin ATX 12V power connector 1 x CPU fan header 2 x System fan headers 1 x Front panel header 1 x Front audio header 1 x 2W Speaker out header 4 x USB 2.0 headers 2 x USB 3.0 headers 5 x COM headers (RS-232) 1 x PS/2 Keyboard/ Mouse Connector 1 x GPIO (8 bits) & SMBUS header 1 x Clear CMOS jumper 1 x Buzzer
Rear I/O	3 x Audio Jacks (Line in, Line out, Mic in) 1 x COM port (RS-232) 1 x HDMI 1 x DVI-D 1 x VGA 2 x RJ45 LAN ports 4 x USB 3.0	3 x Audio Jacks (Line in, Line out, Mic in) 2 x COM ports (RS-232/422/485) 1 x VGA 1 x DVI-D 2 x RJ45 LAN ports 4 x USB 3.0 1 x PS2 KB/MS	3 x Audio Jacks (Line in, Line out, Mic in) 1 x COM port (RS-232/422/485 & RI/5V/12V) 1 x HDMI 1 x Display Port 1 x VGA 2 x RJ45 LAN ports 4 x USB 3.0 1 x USB 3.1 Gen2 1 x USB 3.1 Gen2 (Type C)
TPM	Onboard TPM 2.0 security chip INFINEON SLB9665VQ2.0	Onboard TPM 1.2 security chip INFINEON SLB9635TT1.2	1 x TPM header
Operating Temp.	0°C to 60°C	0°C to 60°C	0°C to 60°C
Ordering Information	9MDH11BMNR-SI (Bulk packing)	9MATMH81NR-SI (Bulk packing) 9MATMH81MR-SI (Box packing)	9MZRYZBMNR-SI (Bulk packing)

Mini-ITX Series

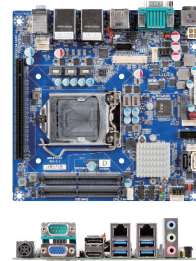
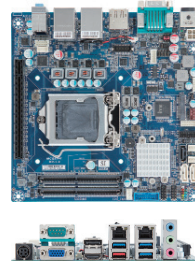
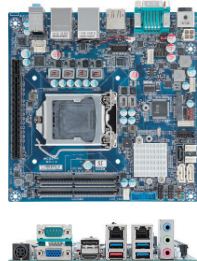

Model Name	mITX-Q47EA	mITX-Q370A	mITX-H310A
CPU	Support for 10th Generation Intel® Core™ i7/i5/i3, Pentium® & Celeron® processors, TDP under 65W	Support for 8th/9th Generation Intel® Core™ i7/i5/i3, Pentium® & Celeron® processors, TDP under 65W	Support for 8th/9th Generation Intel® Core™ i7/i5/i3, Pentium® & Celeron® processors, TDP under 65W
Socket	LGA 1200	LGA 1151	LGA 1151
Chipset	Intel® Q470E Chipset	Intel® Q370 Chipset	Intel® H310 Chipset
Memory	2 x DDR4 SO-DIMM sockets, Max. Capacity 64 GB, Support Dual Channel DDR4 2933/2666/2400 MHz	2 x DDR4 SO-DIMM sockets, Max. Capacity 32 GB, Support Dual Channel DDR4 2666/2400 MHz	2 x DDR4 SO-DIMM sockets, Max. Capacity 32 GB, Support Dual Channel DDR4 2666/2400 MHz
Ethernet	2 x GbE LAN ports (Intel® I219V and Intel® I211AT)	2 x GbE LAN ports (Intel® I219LM and Intel® I211AT)	2 x GbE LAN ports (Intel® I219V and Intel® I211AT)
Graphic	Integrated Graphics Processor - Intel® HD Graphics: 1 x HDMI 2.0 1 x Display Port 1 x VGA 1 x eDP/LVDS 3 independent display outputs	Integrated Graphics Processor - depends on CPU: 1 x HDMI 1.4 1 x Display Port 1 x VGA 1 x eDP 3 independent display outputs	Integrated Graphics Processor - depends on CPU: 1 x HDMI 1.4 1 x Display Port 1 x VGA 1 x LVDS or eDP 2 independent display outputs
Audio	Realtek® Audio codec	Realtek® Audio Codec	Realtek® Audio Codec
Storage	3 x SATA 6Gb/s ports (RAID 0/1/5/10)	3 x SATA 6Gb/s ports (RAID 0/1/5/10)	2 x SATA 6Gb/s ports
Expansion Slots	1 x PCIe x16 (Gen3 x16) 1 x 2280/2242 M.2 M-Key (PCIe x4, SATA 6Gb/s) 1 x 2230 M.2 E-Key	1 x PCIe x16 (Gen3 x16) 1 x 2280/2242 M.2 M-Key (PCIe x4, SATA 6Gb/s, Optane memory) 1 x 2230 M.2 E-Key	1 x PCIe x16 (Gen3 x16) 1 x 2280/2242 M.2 M-Key (SATA 6Gb/s) 1 x 2230 M.2 E-Key
Internal I/O	1 x 4-pin ATX main power connector 2 x SATA power connectors 1 x CPU fan header 1 x System fan header 1 x Front panel header 1 x Front panel audio header 1 x 2W Speaker out header 4 x USB 2.0 headers 1 x COM header (RS-232) 1 x GPIO (8 bits) & SMBUS header 1 x Backlight Control header 1 x Clear CMOS jumper 1 x Buzzer 1 x PSU on header 2 x USB3.2 headers Gen1x1	1 x 4-pin ATX main power connector 2 x SATA power connectors 1 x CPU fan header 1 x System fan header 1 x Front panel header 1 x Front panel audio header 1 x 2W Speaker out header 4 x USB 2.0 headers 2 x USB 3.0 headers 1 x COM header (RS-232) 1 x GPIO (8 bits) & SMBUS header 1 x Backlight Control header 1 x Clear CMOS jumper 1 x Buzzer	1 x 4-pin ATX main power connector 1 x SATA power connector 1 x CPU fan header 1 x System fan header 1 x Front panel header 1 x Front panel audio header 1 x 2W Speaker out header 4 x USB 2.0 headers 2 x COM headers (RS-232) 1 x COM header (RS-232/422/485 & RI/5V/12V) 1 x GPIO (8 bits) & SMBUS header 1 x Backlight Control header 1 x Clear CMOS jumper 1 x Buzzer
Rear I/O	3 x Audio Jacks (Line in, Line out, Mic in) 1 x COM port (RS-232/422/485 & RI/5V/12V) 1 x HDMI 1 x Display Port 1 x VGA 2 x RJ45 LAN ports 1 x USB3.2 Gen2x1 Gen2 1 x DC Jack (+12V/+19~24VDC) 3 x USB3.2 Gen1x1	3 x Audio Jacks (Line in, Line out, Mic in) 1 x COM port (RS-232/422/485 & RI/5V/12V) 1 x HDMI 1 x Display Port 1 x VGA 2 x RJ45 LAN ports 3 x USB 3.0 1 x USB 3.1 Gen2 1 x DC Jack (+12V/+19V/+24VDC)	3 x Audio Jacks (Line in, Line out, Mic in) 1 x COM port (RS-232/422/485 & RI/5V/12V) 1 x HDMI 1 x Display Port 1 x VGA 2 x RJ45 LAN ports 4 x USB 3.0 1 x DC Jack (+12V/+19V/+24VDC)
TPM	1 x TPM header	1 x TPM header	1 x TPM header
Operating Temp.	0°C to 60°C	0°C to 60°C	0°C to 60°C
Ordering Information	9MQ47EAIMR-SI (Box packing)	9MCQ37AINR-SI (Bulk packing)	9MH310AIMR-SI (Box packing)

Mini-ITX Series

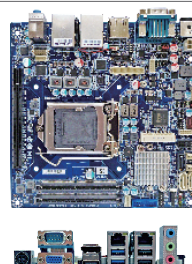
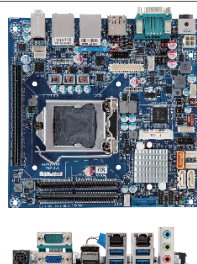

Mini-ITX Series

Model Name	mITX-Q170A	mITX-H110A	mITX-H110B
CPU	Supports for 6/7th Generation Intel® Core™ i7/i5/i3, Pentium® & Celeron® processors, TDP under 65W	Supports for 6/7th Generation Intel® Core™ i7/i5/i3, Pentium® & Celeron® processors, TDP under 65W	Supports for 6/7th Generation Intel® Core™ i7/i5/i3, Pentium® & Celeron® processors, TDP under 65W
Socket	LGA 1151	LGA 1151	LGA 1151
Chipset	Intel® Q170 Chipset	Intel® H110 Chipset	Intel® H110 Chipset
Memory	2 x DDR4 SO-DIMM sockets, Max. Capacity 32 GB, Support Dual Channel DDR4 2400/2133 MHz	2 x DDR4 SO-DIMM sockets, Max. Capacity 32 GB, Support Dual Channel DDR4 2400/2133 MHz	2 x DDR4 SO-DIMM sockets, Max. Capacity 32 GB, Support Dual Channel DDR4 2400/2133 MHz
Ethernet	2 x GbE LAN ports (Intel® I219LM and Intel® I211AT)	2 x GbE LAN ports (Intel® I219V and Intel® I211AT)	6 x GbE LAN ports (1 x Intel® I219V and 5 x Intel® I211AT)
Graphic	Integrated Graphics Processor - depends on CPU: 1 x HDMI 1.4, 1 x Display Port 1 x LVDS or eDP 3 independent display outputs	Integrated Graphics Processor - depends on CPU: 1 x HDMI 1.4, 1 x Display Port, 1 x VGA , 1 x LVDS or eDP 2 independent display outputs	Integrated Graphics Processor - depends on CPU: 1 x HDMI 1.4 1 x VGA 2 independent display outputs
Audio	Realtek® Audio Codec	Realtek® Audio Codec	Realtek® Audio Codec
Storage	3 x SATA 6Gb/s ports (RAID 0/1/5/10) (incl. 1 x SATA supports SATA DOM)	3 x SATA 6Gb/s ports (incl. 1 x SATA supports SATA DOM)	2 x SATA 6Gb/s ports
Expansion Slots	1 x PCIe x16 (Gen3 x16) 1 x 2280/2242 M.2 M-Key (PCIe x4, SATA 6Gb/s) 1 x Full-size Mini PCIe/mSATA	1 x PCIe x16 (Gen3 x16) 1 x 2280/2242 M.2 M-Key (SATA 6Gb/s) 1 x Full-size Mini PCIe	1 x PCIe x16 (Gen3 x16) 1 x 2280/2242 M.2 M-Key (SATA 6Gb/s) 1 x Full-size mSATA
Internal I/O	1 x 4-pin ATX main power connector 2 x SATA power connectors 1 x CPU fan header 1 x System fan header 1 x Front panel header 1 x Front panel audio header 1 x 2W Speaker out header 4 x USB 2.0 headers 2 x USB 3.0 headers 1 x COM header (RS-232/422/485 & RI/5V/12V) 1 x GPIO (8 bits) & SMBUS header 1 x Backlight Control header 1 x Clear CMOS jumper 1 x Buzzer	1 x 4-pin ATX main power connector 2 x SATA power connectors 1 x CPU fan header 1 x System fan header 1 x Front panel header 1 x Front panel audio header 1 x 2W Speaker out header 3 x USB 2.0 headers 2 x USB 3.0 headers 1 x COM header (RS-232/422/485 & RI/5V/12V) 1 x GPIO (8 bits) & SMBUS header 1 x Backlight Control header 1 x Clear CMOS jumper 1 x Buzzer	1 x 4-pin ATX main power connector 2 x SATA power connectors 1 x CPU fan header 1 x System fan header 1 x Front panel header 1 x Front panel audio header 1 x 2W Speaker out header 6 x USB 2.0 headers 2 x COM headers (RS-232/422/485 & RI/5V/12V) 1 x GPIO (8 bits) & SMBUS header 1 x Clear CMOS jumper 1 x Buzzer
Rear I/O	3 x Audio Jacks (Line in, Line out, Mic in) 1 x COM port (RS-232/422/485 & RI/5V/12V) 1 x HDMI 1 x Display Port 1 x VGA 2 x RJ45 LAN ports 4 x USB 3.0 1 x DC Jack (+12V/+19V/+24VDC)	3 x Audio Jacks (Line in, Line out, Mic in) 1 x COM port (RS-232/422/485 & RI/5V/12V) 1 x HDMI 1 x Display Port 1 x VGA 2 x RJ45 LAN ports 2 x USB 2.0 2 x USB 3.0 1 x DC Jack (+12/+19/+24VDC)	3 x Audio Jacks (Line in, Line out, Mic in) 1 x HDMI 1 x VGA 6 x RJ45 LAN ports 4 x USB 3.0 1 x DC Jack (+12V/+19V/+24VDC)
TPM	1 x TPM header	1 x TPM header	1 x TPM header
Operating Temp.	0°C to 60°C	0°C to 60°C	0°C to 60°C
Ordering Information	9MDQ17BIMR-SI (Box packing)	9MDH11LIMR-SI (Box packing)	9MH110AIMR-SI (Box packing)

Mini-ITX Series

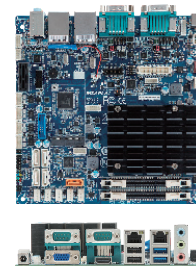
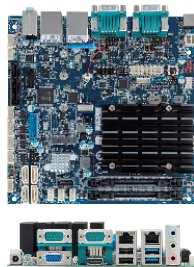

Model Name	mITX-4125A	mITX-4205A
CPU	Intel® Celeron® J4125 Processor, 14nm, 4 cores, 4 threads, up to 2.7 GHz, TDP 10W, fan-less design	Intel® Pentium® J4205 Processor, 14nm, 4 cores, 4 threads, up to 2.6 GHz, TDP 10W, fan-less design
Socket	FCBGA1090	FCBGA1296
Chipset	—	—
Memory	2 x DDR4 SO-DIMM sockets, Max. Capacity 8 GB, Support Dual Channel DDR4 2400 MHz	2 x DDR3L SO-DIMM sockets, Max. Capacity 8 GB, Support Dual Channel DDR3L 1866 MHz
Ethernet	2 x GbE LAN ports (Realtek® RTL8111HS)	2 x GbE LAN ports (Realtek® RTL8111HS)
Graphic	Integrated Graphics Processor - Intel® UHD Graphics 600: 1 x HDMI 2.0 1 x VGA 1 x LVDS or eDP 3 independent display outputs	Integrated Graphics Processor - Intel® HD Graphics 505: 1 x HDMI 1.4 1 x VGA 1 x LVDS or eDP 3 independent display outputs
Audio	Realtek® Audio Codec	Realtek® Audio Codec
Storage	5 x SATA 6Gb/s ports (4 x from Marvell 88SE9230, support RAID 0/1/10) (1 x from J4105 supports SATA DOM)	5 x SATA 6Gb/s ports (4 x from Marvell 88SE9230, support RAID 0/1/10) (1 x from J4205 supports SATA DOM)
Expansion Slots	1 x PCIe x4 (Gen2 x2) 1 x 2280/2260/2242 M.2 M-Key (SATA 6Gb/s) 1 x 2230 M.2 E-Key (CNVi cards only)	1 x PCIe x1 (Gen2 x1) 1 x Full-size mSATA
Internal I/O	1 x 4-pin ATX main power connector 3 x SATA power connectors 1 x CPU fan header 1 x System fan header 1 x Front panel header 1 x Front panel audio header 1 x 2W Speaker out header 2 x USB 2.0 headers 2 x USB 3.0 headers 4 x COM headers (RS-232) 1 x GPIO (8 bits) & SMBUS header 1 x Case open header 1 x AT/ATX mode jumper 1 x Backlight Control header 1 x RAID LED header 2 x LAN LED headers 1 x Clear CMOS jumper 1 x Buzzer	1 x 4-pin ATX power connector 5 x SATA power connectors 1 x CPU fan header 1 x System fan header 1 x Front panel header 1 x Front panel audio header 1 x 2W Speaker out header 2 x USB 2.0 headers 2 x USB 3.0 headers 4 x COM headers (RS-232) 1 x GPIO (8 bits) & SMBUS header 1 x Case open header 1 x PS/2 KB/MS Connector 1 x Backlight Control header 1 x RAID LED header 2 x LAN LED headers 1 x Clear CMOS jumper 1 x Buzzer
Rear I/O	3 x Audio Jacks (Line in, Line out, Mic in) 2 x COM ports (RS-232/422/485 & RI/5V/12V) 1 x HDMI 2.0 1 x VGA 2 x RJ45 LAN ports 2 x USB 2.0 2 x USB 3.0 1 x DC Jack (+12VDC)	3 x Audio Jacks (Line in, Line out, Mic in) 2 x COM ports (RS-232/422/485 & RI/5V/12V) 1 x HDMI 1 x VGA 2 x RJ45 LAN ports 2 x USB 2.0 2 x USB 3.0 1 x DC Jack (+12VDC)
TPM	1 x TPM header	1 x TPM header
Operating Temp.	0°C to 60°C	0°C to 60°C
Ordering Information	9MGMLJAINR-SI (Bulk packing)	Fanless version: 9MZAPLAINR-SI (Bulk packing)

Mini-ITX Series

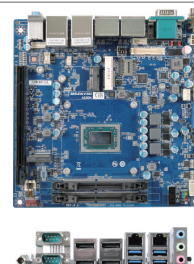
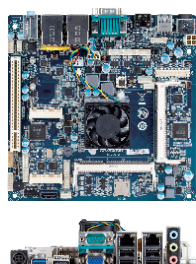

Mini-ITX Series/Thin-Mini-ITX Series

Model Name	mITX-1900A	mITX-1605A
CPU	Intel® Celeron® J1900 Processor, 22nm, 4 cores, 4 threads, up to 2.42 GHz, TDP 10W	AMD® RYZEN™ Embedded V1605B, 14nm, 4 cores, 8 threads, 2.0 GHz, up to 3.6 GHz, TDP 25W
Socket	FCBGA1170	FP5 BGA
Chipset	—	—
Memory	2 x DDR3L SO-DIMM sockets, Max. Capacity 8 GB, Support Dual Channel DDR3L 1333MHz	2 x DDR4 SO-DIMM sockets, Max. Capacity 32 GB, Support Dual Channel DDR4 2400 MHz
Ethernet	2 x GbE LAN ports (Realtek® RTL8111G)	2 x GbE LAN ports (Realtek® RTL8111HS)
Graphic	Integrated Graphics Processor - Intel® HD Graphics: 1 x HDMI 1.4 1 x VGA 1 x LVDS 2 independent display outputs	Integrated Graphics Processor - AMD Radeon™ Vega 8 Graphics: 4 x Display Port 1 x LVDS (Share from DP) 4 independent display outputs
Audio	Realtek® Audio Codec	Realtek® Audio Codec
Storage	1 x SATA 3Gb/s port (incl. 1 x SATA supports SATA DOM)	1 x SATA 6Gb/s port
Expansion Slots	1 x PCI 1 x Full-size Mini PCIe 1 x Full-size mSATA	1 x PCIe x16 (Gen3 x8) 1 x 2280 M.2 M-Key (SATA 6Gb/s) 1 x 2230 M.2 E-Key 1 x Full-size Mini PCIe with SIM slot
Internal I/O	1 x 4-pin ATX power connector 1 x SATA power header 1 x CPU fan header 1 x System fan header 1 x Front panel header 1 x Front audio header 1 x 2W Speaker out header 2 x USB 2.0 headers 1 x COM header (RS-232/422/485) 3 x COM headers (RS-232) 1 x COM header (RS-232 & RI/5V/12V) 1 x GPIO (8 bits) & SMBUS header 1 x PS/2 KB/MS Connector 1 x AT/ATX mode jumper 1 x Backlight control header 1 x Clear CMOS jumper 1 x Buzzer	1 x 4-pin ATX power connector 1 x SATA power connector 1 x CPU fan header 1 x System fan header 1 x Front panel header 1 x Front panel audio header 1 x 2W Speaker out header 6 x USB 2.0 headers 2 x COM headers (RS-232) 1 x GPIO (8 bits) & SMBUS header 1 x Backlight Control header 1 x LVDS/ DP Jumper 1 x AT/ATX mode jumper 1 x Clear CMOS jumper
Rear I/O	3 x Audio Jacks (Line in, Line out, Mic in) 1 x COM port (RS-232) 1 x HDMI 1 x VGA 2 x RJ45 LAN ports 4 x USB 2.0 1 x USB 3.0 1 x DC Jack (+12VDC)	3 x Audio Jacks (Line in, Line out, Mic in) 2 x COM ports (RS-232/422/485 & RI/5V/12V) 4 x Display Port 2 x RJ45 LAN ports 4 x USB 3.0 1 x DC Jack (+12V~24VDC)
TPM	1 x TPM header	1 x TPM header
Operating Temp.	0°C to 60°C	0°C to 60°C
Ordering Information	Fan version: 9MVBAYAINS-SI (Bulk packing) Fanless version: 9MVBAYAINS-00 (Bulk packing)	Fan version: 9MRZNVIMIR-SI (Box packing)

Thin Mini-ITX Series

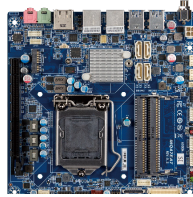

Preliminary

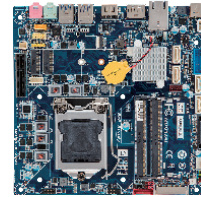
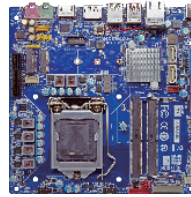

Model Name	iTXL-Q47EA	iTXL-Q370A	iTXL-Q170A
CPU	Support for 10th Generation Intel® Core™ i9/i7/i5/i3, Pentium® & Celeron® processors, TDP under 65W	Support for 8th/9th Generation Intel® Core™ i7/i5/i3, Pentium® & Celeron® processors, TDP under 65W	Supports for 6/7th Generation Intel® Core™ i7/i5/i3, Pentium® & Celeron® processors, TDP under 65W
Socket	LGA 1200	LGA 1151	LGA 1151
Chipset	Intel® Q470E Chipset	Intel® Q370 Chipset	Intel® Q170 Chipset
Memory	2 x DDR4 SO-DIMM sockets, Max. Capacity 32 GB, Support Dual Channel DDR4 2933/2666/2400 MHz	2 x DDR4 SO-DIMM sockets, Max. Capacity 32 GB, Support Dual Channel DDR4 2666/2400 MHz	2 x DDR4 SO-DIMM sockets, Max. Capacity 32 GB, Support Dual Channel DDR4 2400/2133 MHz
Ethernet	2 x GbE LAN ports (Intel® I219LM and Intel® I211AT)	1 x GbE LAN port (Intel® I219LM)	1 x GbE LAN port (Intel® I219LM)
Graphic	Integrated Graphics Processor - Intel® HD Graphics: 1 x HDMI 2.0 1 x Display Port 1 x LVDS/eDP 3 independent display outputs	Integrated Graphics Processor - depends on CPU: 1 x HDMI 2.0 1 x Display Port 1 x LVDS 3 independent display outputs	Integrated Graphics Processor - depends on CPU: 1 x HDMI 1.4 1 x Display Port 1 x LVDS 3 independent display outputs
Audio	Realtek® Audio codec with 2W amplifier	Realtek® Audio Codec	Realtek® Audio Codec
Storage	4 x SATA 6Gb/s ports (RAID 0/1/5/10)	4 x SATA 6Gb/s ports (RAID 0/1/5/10)	4 x SATA 6Gb/s ports (RAID 0/1/5/10)
Expansion Slots	1 x PCIe x16 (Gen3 x16) 1 x 2280 M.2 M-Key (PCIe x4, SATA 6Gb/s) 1 x 2230 M.2 E-Key	1 x PCIe x4 (Gen3 x4) 1 x 2280/2260 M.2 M-Key (PCIe x4, SATA 6Gb/s, Optane memory) 1 x 2230 M.2 E-Key	1 x PCIe x4 (Gen3 x4) 1 x 2280/2260 M.2 M-Key (PCIe x4, SATA 6Gb/s) 1 x 2230 M.2 E-Key
Internal I/O	1 x 4-pin ATX main power connector 2 x SATA Power connector 1 x CPU fan header 1 x System fan header 1 x Front panel header 1 x Front panel audio header 1 x 2W Speaker out header 1 x GPIO (8 bits) & SMBus header 1 x PSU on (support ATX PSU) 1 x DMIC header 6 x USB 2.0 headers 1 x COM header (RS-232) 1 x COM header (RS-232/422/485 & RI/5V/12V) 1 x FPD (For LVDS 19V) 1 x FPD_SW 1x3 (For Panel Power SW) 1 x LCD_VCC Pin header 1 x Backlight Control header	1 x 2-pin ATX main power connector 1 x SATA Power connector 1 x CPU fan header 1 x System fan header 1 x Front panel header 1 x Front panel audio header 1 x 3W Speaker out header 1 x DMIC header 5 x USB 2.0 headers 2 x USB 3.0 headers 1 x COM header (RS-232) 1 x FPD (For LVDS 19V) 1 x FPD_SW 1x3 (For Panel Power SW) 1 x LCD_VCC Pin header 1 x Backlight Control header	1 x 2-pin ATX main power connector 1 x SATA Power connector 1 x CPU fan header 1 x System fan header 1 x Front panel header 1 x Front panel audio header 1 x 3W Speaker out header 1 x DMIC header 5 x USB 2.0 headers 2 x USB 3.0 headers 1 x COM header (RS-232) 1 x FPD (For LVDS 19V) 1 x FPD_SW 1x3 (For Panel Power SW) 1 x LCD_VCC Pin header 1 x Backlight Control header 1 x NFC connector
Rear I/O	2 x Audio Jacks (Line out, Mic in) 1 x HDMI 1 x Display Port 2 x RJ45 LAN port 4 x USB 3.2 Gen1x1 1 x DC Jack (+12V/+19~24VDC)	2 x Audio Jacks (Line out, Mic in) 1 x HDMI 1 x Display Port 1 x RJ45 LAN port 3 x USB 3.0 1 x USB 3.0 Type C 1 x DC Jack (+12V/+19VDC)	2 x Audio Jacks (Line out, Mic in) 1 x HDMI 1 x Display Port 1 x RJ45 LAN port 4 x USB 3.0 1 x DC Jack (+12V/+19VDC)
TPM	1 x TPM header	1 x TPM header	Onboard TPM 2.0 security chip INFINEON SLB9665VQ2.0
Operating Temp.	0°C to 60°C	0°C to 60°C	0°C to 60°C
Ordering Information	9MQ47EATMR-SI (Box packing)	9MQ37ATMR-SI (Box packing)	9MDQ17AINR-SI (Bulk packing)

Thin Mini-ITX Series

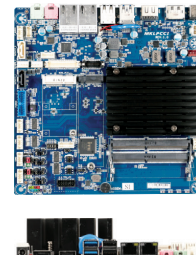
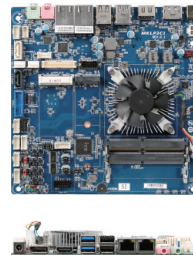
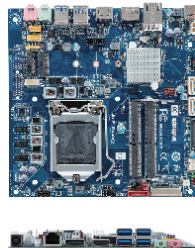

Thin Mini-ITX Series

Model Name	iTXL-H110C	iTXL-6100B	iTXL-3955A
CPU	Supports for 6/7th Generation Intel® Core™ i7/i5/i3, Pentium® & Celeron® processors, TDP under 65W	Intel® Core™ i3-6100U Processor, 14nm, 2 cores, 4 threads, 2.3 GHz, TDP 15W	Intel® Celeron® 3955U Processor, 14nm, 2 cores, 4 threads, 2.0 GHz, TDP 15W
Socket	LGA 1151	FCBGA1356	FCBGA1356
Chipset	Intel® H110 Chipset	—	—
Memory	2 x DDR4 SO-DIMM sockets, Max. Capacity 32 GB, Support Dual Channel DDR4 2400/2133 MHz	2 x DDR4 SO-DIMM sockets, Max. Capacity 32 GB, Support Dual Channel DDR4 2133 MHz	2 x DDR4 SO-DIMM sockets, Max. Capacity 32 GB, Support Dual Channel DDR4 2133 MHz
Ethernet	1 x GbE LAN port (Realtek® RTL8111HS)	2 x GbE LAN ports (Intel® I219V and Intel® I211AT)	2 x GbE LAN ports (Intel® I219V and Intel® I211AT)
Graphic	Integrated Graphics Processor - depends on CPU: 1 x HDMI1.4 1 x Display Port 1 x LVDS 2 independent display outputs	Integrated Graphics Processor - Intel® HD Graphics 520: 1 x HDMI 1.4 1 x Display Port 1 x LVDS or eDP 3 independent display outputs	Integrated Graphics Processor - Intel® HD Graphics 510: 1 x HDMI 1.4 1 x Display Port 1 x LVDS or eDP 3 independent display outputs
Audio	Realtek® Audio Codec	Realtek® Audio Codec	Realtek® Audio Codec
Storage	2 x SATA 6Gb/s ports	2 x SATA 6Gb/s ports (RAID 0/1/5) (incl. 1 x SATA supports SATA DOM)	2 x SATA 6Gb/s ports (incl. 1 x SATA supports SATA DOM)
Expansion Slots	1 x 2280/2260 M.2 M-Key (PCIe x2, SATA 6Gb/s) 1 x 2230 M.2 E-Key	1 x 2280/2242 M.2 M-Key (PCIe x2, SATA 6Gb/s) 1 x Full-size Mini PCIe	1 x 2280/2242 M.2 M-Key (PCIe x2, SATA 6Gb/s) 1 x Full-size Mini PCIe
Internal I/O	1 x 2-pin ATX main power connector 1 x SATA Power connector 1 x CPU fan header 1 x System fan header 1 x Front panel header 1 x Front panel audio header 1 x 3W Speaker out header 1 x DMIC header 5 x USB 2.0 headers 1 x COM header (RS-232) 1 x FPD (For LVDS 19V) 1 x FPD_SW 1x3 (For Panel Power SW) 1 x LCD_VCC Pin header 1 x Backlight Control header	1 x 4-pin ATX main power connector 2 x SATA Power connectors 1 x CPU fan header 1 x System fan header 1 x Front panel header 1 x Front panel audio header 1 x 2W Speaker out header 2 x USB 2.0 headers 2 x USB 3.0 headers 2 x COM headers (RS-232) 2 x COM headers (RS-232/422/485 & RI/5V/12V) 1 x LCD_VCC Pin header 1 x Backlight Control header 1 x Backlight Control header 1 x GPIO (8 bits) & SMBUS header 1 x Buzzer	1 x 4-pin ATX main power connector 2 x SATA Power connectors 1 x CPU fan header 1 x System fan header 1 x Front panel header 1 x Front panel audio header 1 x 2W Speaker out header 2 x USB 3.0 headers 2 x COM headers (RS-232) 2 x COM headers (RS-232/422/485 & RI/5V/12V) 1 x LCD_VCC Pin header 1 x Backlight Control header 1 x GPIO (8 bits) & SMBUS header 1 x Buzzer
Rear I/O	2 x Audio Jacks (Line out, Mic in) 1 x HDMI 1 x Display Port 1 x RJ45 LAN port 4 x USB 3.0 1 x DC Jack (+12V/+19VDC)	2 x Audio Jacks (Line out, Mic in) 1 x HDMI 1 x Display Port 2 x RJ45 LAN ports 2 x USB 2.0 2 x USB 3.0 1 x DC Jack (+12VDC)	2 x Audio Jacks (Line out, Mic in) 1 x HDMI 1 x Display Port 2 x RJ45 LAN ports 2 x USB 2.0 2 x USB 3.0 1 x DC Jack (+12VDC)
TPM	1 x TPM header	1 x TPM header	1 x TPM header
Operating Temp.	0°C to 60°C	0°C to 60°C	0°C to 60°C
Ordering Information	9MDH11KINR-SI (Bulk packing)	9MKLP3CIMR-SI (Box packing)	9MKLPCCIMR-SI (Box packing)

Thin Mini-ITX Series

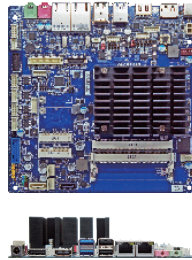

Model Name	iTXL-3350A	iTXL-1900A
CPU	Intel® Celeron® N3350 Processor, 14nm, 2 cores, 2 threads, up to 2.4 GHz, TDP 6W	Intel® Celeron® J1900 Processor, 22nm, 4 cores, 4 threads, up to 2.42 GHz, TDP 10W
Socket	FCBGA1296	FCBGA1170
Chipset	—	—
Memory	2 x DDR3L SO-DIMM sockets, Max. Capacity 8 GB, Support Dual Channel DDR3L 1866 MHz	2 x DDR3L SO-DIMM sockets, Max. Capacity 8 GB, Support Dual Channel DDR3L 1333 MHz
Ethernet	2 x GbE LAN ports (Realtek® RTL8111HS)	1 x GbE LAN ports (Realtek® RTL8111G)
Graphic	Integrated Graphics Processor - Intel® HD Graphics 500: 1 x HDMI 1.4 1 x Display Port 1 x LVDS or eDP 3 independent display outputs	Integrated Graphics Processor - Intel® HD Graphics: 1 x HDMI 1.4 1 x VGA 1 x LVDS 2 independent display outputs
Audio	Realtek® Audio Codec	Realtek® Audio Codec
Storage	2 x SATA 6Gb/s ports (1 x switches with mSATA) (incl. 1 x SATA supports SATA DOM)	1 x SATA 6Gb/s port (switches with mSATA) 2 x SATA 3Gb/s ports eMMC (Optional)
Expansion Slots	1 x Full-size Mini PCIe/mSATA 1 x Half-size Mini PCIe (PCIe Only)	1 x PCIe x4 (Gen2 x4) 1 x mSATA (SATA 6Gb/s) 1 x Half-size Mini PCIe
Internal I/O	1 x 4-pin ATX main power connector 2 x SATA Power connectors 1 x CPU fan header 1 x System fan header 1 x Front panel header 1 x Front panel audio header 1 x 2W Speaker out header 1 x USB 2.0 header 2 x USB 3.0 headers 4 x COM headers (RS-232) 2 x COM headers (RS-232/422/485 & RI/5V/12V) 1 x LCD_VCC Pin header 1 x Backlight Control header 1 x PS/2 KB/MS Connector 1 x GPIO (8 bits) & SMBUS header 1 x Buzzer	1 x 2-pin ATX main power connector 1 x SATA power connector 1 x CPU fan header 1 x System fan header 1 x Front panel header 1 x Front panel audio header 1 x 3W Speaker out header 1 x DMIC header 3 x USB 2.0 headers 1 x COM header (RS-232) 1 x FPD (For LVDS 19V) 1 x FPD_SW 1x3 (For Panel Power SW) 1 x LCD_VCC Pin header 1 x Backlight Control header 1 x LPT header 1 x Micro SD connector
Rear I/O	2 x Audio Jacks (Line out, Mic in) 1 x HDMI 1 x Display Port 2 x RJ45 LAN ports 2 x USB 2.0 2 x USB 3.0 1 x DC Jack (+12VDC)	2 x Audio Jacks (Line out, Mic in) 1 x HDMI 1 x VGA 1 x RJ45 LAN port 2 x USB 2.0 1 x USB 3.0 1 x DC Jack (+12V/+19VDC)
TPM	1 x TPM header	—
Operating Temp.	0°C to 60°C	0°C to 60°C
Ordering Information	9MZAPLBINR-SI (Bulk packing) 9MZAPLBIMR-SI (Box packing)	9MZBAYAINR-SI (Bulk packing)

QBiP Series (3.5" SBC)

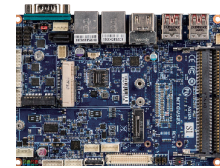

Model Name	QBiP-TGLA	QBiP-TGLB
CPU	Intel® Core™ i7-1165G7 Processor, 10nm SuperFin, 4 cores, 8 threads, up to 4.7GHz, TDP 28W Intel® Core™ i5-1135G7 Processor, 10nm SuperFin, 4 cores, 8 threads, up to 4.2GHz, TDP 28W Intel® Core™ i3-1115G4E Processor, 10nm SuperFin, 2 cores, 4 threads, up to 4.7GHz, TDP 28W	Intel® Core™ i7-1165G7 Processor, 10nm SuperFin, 4 cores, 8 threads, up to 4.7GHz, TDP 28W Intel® Core™ i5-1135G7 Processor, 10nm SuperFin, 4 cores, 8 threads, up to 4.2GHz, TDP 28W Intel® Core™ i3-1115G4E Processor, 10nm SuperFin, 2 cores, 4 threads, up to 4.7GHz, TDP 28W
Socket	FCBGA1449	FCBGA1449
Chipset	SoC	SoC
Memory	2 x DDR4 SO-DIMM sockets, Max. Capacity 32 GB, Support Dual Channel DDR4 2933 MHz	2 x DDR4 SO-DIMM sockets, Max. Capacity 64 GB, Support Dual Channel DDR4 3200 MHz
Ethernet	2 x GbE LAN ports (Intel® I219V and Intel® I211AT)	2 x GbE LAN ports (Intel® I219V and Intel® I211AT)
Graphic	Integrated Graphics Processor - Intel® Iris X® /UHD Graphics 2 x HDMI 2.0 2 x DP 1.4 1 x eDP 4 independent display outputs	Integrated Graphics Processor - Intel® Iris X® Graphics 2 x HDMI 2.0 1 x LVDS 3 independent display outputs
Audio	Realtek® Audio Codec	Realtek® Audio Codec
Storage	1 x SATA 6Gb/s ports (RAID 0/1/5)	1 x SATA 6Gb/s ports (RAID 0/1)
Expansion Slots	1 x 2280 M.2 M-Key (PCIe x2, SATA 6Gb/s) 1 x 2230 M.2 E-Key 1 x 3052 M.2 B-Key with SIM Slot (Support 5G) 1 x PCIe x4 (Board to Wire connector)	1 x 2280 M.2 M-Key (PCIe x2, SATA 6Gb/s) 1 x 2230 M.2 E-Key 1 x Full-size miniPCIe with SIM slot 1 x PCIe x1 (Board to Wire connector)
Internal I/O	1 x 4-pin box power connector(+12V~24VDC) 1 x SATA Power header 1 x CPU fan header 1 x System fan header 1 x Front panel header 1 x Front panel audio header 1 x 2W Speaker out header 2 x USB 2.0 headers 1 x COM headers (RS-232 & 5V/12V/RI) 1 x Backlight Control header 1 x AT/ATX mode select jumper 1 x GPIO (8 bits) & SMBus header	1 x 4-pin box power connector(+9V~48VDC) 1 x SATA Power header 1 x CPU fan header 1 x System fan header 1 x Front panel header 1 x Front panel audio header 1 x 2W Speaker out header 2 x USB 2.0 headers 3 x COM headers (RS-232/422/485) 1 x Backlight Control header 1 x AT/ATX mode select jumper 1 x GPIO (8 bits) & SMBus header
Rear I/O	1 x USB type C (USB3.2 Gen2x1 + DP output-share with DP) & PD Out -100W 1 x USB type C (USB3.2 Gen2x1, PD input-100W) 4 x USB 3.2 Gen2x1 Gen2 2 x HDMI 2.0 2 x DP 1.4 (8K) 2 x RJ45 LAN ports	1 x COM (RS-232/422/485 & RI/5V/12V) 2 x HDMI 2 x RJ45 LAN ports 4 x USB 3.2 Gen2x1 Gen2
TPM	1 x TPM header	1 x TPM header
Operating Temp.	0°C to 60°C	0°C to 60°C
Ordering Information	—	—
Heatsink P/N	—	—
Fan Module P/N	—	—
Heat Spreader P/N	—	—

QBiP Series (3.5" SBC)

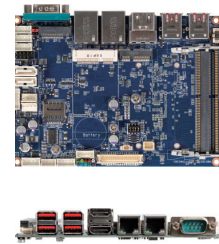
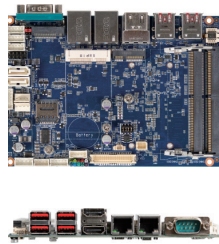

Model Name	QBiP-8565A/ QBiP-8265A/ QBiP-8145A	QBiP-7600A/ QBiP-7200A/ QBiP-7100A
CPU	Intel® Core™ i7-8565U Processor, 14nm, 4 cores, 8 threads, up to 4.6 GHz, TDP 15W (QBiP-8565A) Intel® Core™ i5-8265U Processor, 14nm, 4 cores, 8 threads, up to 3.9 GHz, TDP 15W (QBiP-8265A) Intel® Core™ i3-8145UE Processor, 14nm, 2 cores, 4 threads, up to 3.9 GHz, TDP 15W (QBiP-8145A)	Intel® Core™ i7-7600U Processor, 14nm, 2 cores, 4 threads, up to 3.9 GHz, TDP 15W (QBiP-7600A) Intel® Core™ i5-7200U Processor, 14nm, 2 cores, 4 threads, up to 3.1 GHz, TDP 15W (QBiP-7200A) Intel® Core™ i3-7100U Processor, 14nm, 2 cores, 4 threads, up to 2.4 GHz, TDP 15W (QBiP-7100A)
Socket	FCBGA1528	FCBGA1356
Chipset	SoC	SoC
Memory	2 x DDR4 SO-DIMM sockets, Max. Capacity 32 GB, Support Dual Channel DDR4 2400 MHz	2 x DDR4 SO-DIMM sockets, Max. Capacity 32 GB, Support Dual Channel DDR4 2133 MHz
Ethernet	2 x GbE LAN ports (Intel® I219V and Intel® I211AT)	2 x GbE LAN ports (Intel® I219V and Intel® I211AT) (7600A: Intel® I219LM and Intel® I211AT)
Graphic	Integrated Graphics Processor - Intel® UHD Graphics 620: 2 x HDMI 1.4 1 x LVDS 3 independent display outputs	Integrated Graphics Processor - Intel® HD Graphics 620: 1 x HDMI 2.0 1 x Display Port 1 x LVDS 3 independent display outputs
Audio	Realtek® Audio Codec	Realtek® Audio Codec
Storage	2 x SATA 6Gb/s ports (RAID 0/1/5)	2 x SATA 6Gb/s ports (RAID 0/1/5)
Expansion Slots	1 x 2280 M.2 M-Key (PCIe x4, SATA 6Gb/s) 1 x 2230 M.2 E-Key 1 x Full-size Mini PCIe with SIM slot	1 x 2280 M.2 M-Key (PCIe x4, SATA 6Gb/s) 1 x 2230 M.2 E-Key 1 x Full-size Mini PCIe with SIM slot
Internal I/O	1 x 4-pin box power connector (+9V~36VDC) (48VDC optional) 2 x SATA power headers 1 x CPU fan header 1 x System fan header 1 x Front panel header 1 x Front panel audio header 1 x 2W Speaker out header 2 x USB 2.0 headers 3 x COM headers (RS-232) 1 x Backlight Control header 1 x AT/ATX mode select jumper 1 x GPIO (8 bits) & SMBUS header	1 x 4-pin box power connector (+9V~36VDC) 2 x SATA power headers 1 x CPU fan header 1 x System fan header 1 x Front panel header 1 x Front panel audio header 1 x 2W Speaker out header 2 x USB 2.0 headers 3 x COM headers (RS-232) 1 x Backlight Control header 1 x AT/ATX mode select jumper 1 x GPIO (8 bits) & SMBUS header
Rear I/O	1 x COM port (RS-232/422/485 & RI/5V/12V) 2 x HDMI 2 x RJ45 LAN ports 4 x USB 3.1 Gen2	1 x COM port (RS-232/422/485 & RI/5V/12V) 1 x HDMI 1 x Display Port 2 x RJ45 LAN ports 4 x USB 3.0
TPM	1 x TPM header	1 x TPM header
Operating Temp.	0°C to 60°C	0°C to 60°C
Ordering Information	9MWHLUASMR-SI (Box packing) (QBiP-8565A) 9MWHLUBSMR-SI (Box packing) (QBiP-8265A) 9MWHLUCSMR-SI (Box packing) (QBiP-8145A)	9MFLP7BSMR-SI (Box packing) (QBiP-7600A) 9MFLP5ASMR-SI (Box packing) (QBiP-7200A) 9MFLP3ASMR-SI (Box packing) (QBiP-7100A)
Heatsink P/N	25ST1-153108-A7R	25ST1-153108-A7R
Fan Module P/N	12SF2-01A073-00R	12SF2-01A073-00R
Heat Spreader P/N	25ST5-8265A0-A8R	25ST5-8265A0-A8R

QBiP Series (3.5" SBC)

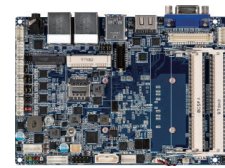
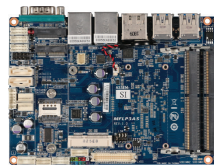
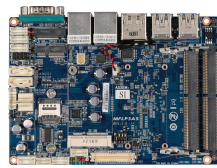

QBiP Series (3.5" SBC)

Model Name	QBiP-7100B	QBiP-3965A	QBiP-4200A
CPU	Intel® Core™ i3-7100U Processor, 14nm, 2 cores, 4 threads, 2.4 GHz, TDP 15W	Intel® Celeron® 3965U Processor, 14nm, 2 cores, 2 threads, 2.2 GHz, TDP 15W	Intel® Pentium® N4200 Processor, 14nm, 4 cores, 4 threads, up to 2.5 GHz, TDP 6W
Socket	FCBGA1356	FCBGA1356	FCBGA1296
Chipset	SoC	SoC	SoC
Memory	2 x DDR4 SO-DIMM sockets, Max. Capacity 32 GB, Support Dual Channel DDR4 2133 MHz	2 x DDR4 SO-DIMM sockets, Max. Capacity 32 GB, Support Dual Channel DDR4 2133 MHz	2 x DDR3L SO-DIMM sockets, Max. Capacity 8 GB, Support Dual Channel DDR3L 1866 MHz
Ethernet	2 x GbE LAN ports (Intel® I219V and Intel® I211AT)	2 x GbE LAN ports (Intel® I219V and Intel® I211AT)	2 x GbE LAN ports (Intel® I211AT)
Graphic	Integrated Graphics Processor - Intel® HD Graphics 620: 1 x HDMI 2.0 1 x Display Port 1 x LVDS 3 independent display outputs	Integrated Graphics Processor - Intel® HD Graphics 610: 1 x HDMI 2.0 1 x Display Port 1 x LVDS 3 independent display outputs	Integrated Graphics Processor - Intel® HD Graphics 505: 1 x HDMI 1.4 1 x VGA 1 x LVDS or eDP 3 independent display outputs
Audio	Realtek® Audio Codec	Realtek® Audio Codec	Realtek® Audio Codec
Storage	2 x SATA 6Gb/s ports (RAID 0/1/5)	2 x SATA 6Gb/s ports	1 x SATA 6Gb/s port 1 x eMMC 32GB
Expansion Slots	1 x 2280 M.2 M-Key (PCIe x4, SATA 6Gb/s) 1 x 2230 M.2 E-Key 1 x 3052 M.2 B-Key (Co-lay Full size miniPCIe)	1 x 2280 M.2 M-Key (SATA 6Gb/s) 1 x 2230 M.2 E-Key 1 x Full-size Mini PCIe with SIM slot	1 x 2242 M.2 M-Key (SATA 6Gb/s) 1 x Full-size Mini PCIe with SIM slot
Internal I/O	1 x 4-pin box power connector (+9V~36VDC) 2 x SATA Power headers 1 x CPU fan header 1 x System fan header 1 x Front panel header 1 x Front panel audio header 1 x 2W Speaker out header 2 x USB 2.0 headers 1 x COM header (RS-232/422/485) 2 x COM headers (RS-232) 1 x Backlight Control header 1 x AT/ATX mode select jumper 1 x GPIO (8 bits) & SMBUS header	1 x 4-pin box power connector (+9V~36VDC) 2 x SATA power headers 1 x CPU fan header 1 x System fan header 1 x Front panel header 1 x Front panel audio header 1 x 2W Speaker out header 2 x USB 2.0 headers 3 x COM headers (RS-232) 1 x Backlight Control header 1 x AT/ATX mode select jumper 1 x GPIO (8 bits) & SMBUS header	1 x 4-pin box power connector (+9V~36VDC) 1 x SATA power header 1 x System fan header 1 x Front panel header 1 x Front panel audio header 1 x 2W Speaker out header 2 x USB 2.0 headers 3 x COM headers (RS-232) 1 x COM header (RS-232/422/485 & RI/5V/12V) 1 x Backlight Control header 1 x AT/ATX mode select jumper 1 x GPIO (8 bits) & SMBUS header 1 x Buzzer header
Rear I/O	1 x COM port (RS-232/422/485 & RI/5V/12V) -- Finktek 1 x HDMI 1 x Display Port 2 x RJ45 LAN ports 4 x USB 3.0	1 x COM port (RS-232/422/485 & RI/5V/12V) 1 x HDMI 2.0 1 x Display Port 2 x RJ45 LAN ports 4 x USB 3.0	1 x Headphone Jack 1 x HDMI 1 x VGA 2 x RJ45 LAN ports 2 x USB 3.0
TPM	1 x TPM header	—	1 x TPM header
Operating Temp.	0°C to 60°C		0°C to 60°C
Ordering Information	—	9MFLPCASMR-SI (Box packing)	9MZAPLASMR-SI (Box packing)
Heatsink P/N	25ST1-153108-A7R	25ST1-153108-A7R	25ST1-153109-A7R
Fan Module P/N	12SF2-01A073-00R	12SF2-01A073-00R	—
Heat Spreader P/N	25ST5-CKAC00-A8R	25ST5-CKAC00-A8R	25ST5-CBAB00-A8R

QBiP Series (3.5" SBC)

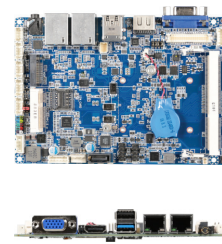
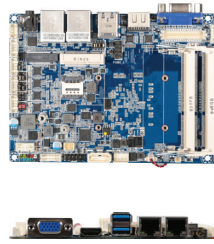
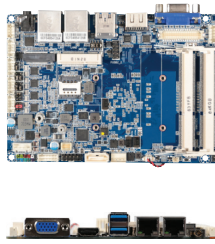

Model Name	QBiP-4200B/ QBiP-4200C/ QBiP-3350A	QBiP-E3940A	QBiP-1900A
CPU	Intel® Pentium® N4200 Processor, 14nm, 4 cores, 4 threads, up to 2.5 GHz, TDP 6W (QBiP-4200B/ 4200C) Intel® Celeron® N3350 Processor, 14nm, 2 cores, 2 threads, up to 2.4 GHz, TDP 6W (QBiP-3350A)	Intel® Atom® x5-E3940 Processor, 14nm, 4 cores, 4 threads, up to 1.8 GHz, TDP 9.5W	Intel® Celeron® J1900 Processor, 22nm, 4 cores, 4 threads, up to 2.42GHz, TDP 10W
Socket	FCBGA1296	FCBGA1296	FCBGA1170
Chipset	SoC	SoC	SoC
Memory	2 x DDR3L SO-DIMM sockets, Max. Capacity 8 GB, Support Dual Channel DDR3L 1866 MHz	2 x DDR3L SO-DIMM sockets, Max. Capacity 8 GB, Support Dual Channel DDR3L 1866 MHz	1 x DDR3L SO-DIMM socket, Max. Capacity 8 GB, Support Single Channel DDR3L 1333 MHz
Ethernet	2 x GbE LAN ports (Intel® I211AT)	2 x GbE LAN ports (Intel® I211AT)	2 x GbE LAN ports (Intel® I211AT)
Graphic	Integrated Graphics Processor - Intel® HD Graphics 505: 1 x HDMI 1.4, 1 x VGA, 1 x LVDS 3 independent display outputs	Integrated Graphics Processor - Intel® HD Graphics 500: 1 x HDMI 1.4, 1 x VGA, 1 x LVDS 3 independent display outputs	Integrated Graphics Processor - Intel® HD Graphics: 1 x HDMI 1.4, 1 x VGA, 1 x LVDS 2 independent display outputs
Audio	Realtek® Audio Codec	Realtek® Audio Codec	Realtek® Audio Codec
Storage	1 x SATA 6Gb/s port 1 x eMMC 32GB (4200B only)	1 x SATA 6Gb/s port	1 x SATA 3Gb/s port
Expansion Slots	1 x 2242 M.2 M-Key (SATA 6Gb/s) 1 x Full-size Mini PCIe with SIM slot	1 x 2242 M.2 M-Key (SATA 6Gb/s) 1 x Full-size Mini PCIe with SIM slot	1 x 2280 M.2 M-Key (SATA 3Gb/s) 1 x Full-size Mini PCIe with SIM slot
Internal I/O	1 x 4-pin box power connector (+9V~36VDC) 1 x SATA power header 1 x System fan header 1 x Front panel header 1 x Front panel audio header 1 x 2W Speaker out header 4 x USB 2.0 headers 3 x COM headers (RS-232) 1 x COM header (RS-232/422/485 & RI/5V/12V) 1 x Backlight Control header 1 x AT/ATX mode select jumper 1 x GPIO (8 bits) & SMBUS header 1 x Buzzer header	1 x 4-pin box power connector (+9V~36VDC) 1 x SATA power header 1 x System fan header 1 x Front panel header 1 x Front panel audio header 1 x 2W Speaker out header 4 x USB 2.0 headers 3 x COM headers (RS-232) 1 x COM header (RS-232/422/485 & RI/5V/12V) 1 x Backlight Control header 1 x AT/ATX mode select jumper 1 x GPIO (8 bits) & SMBUS header 1 x Buzzer header	1 x 4-pin box power connector (+9V~36VDC) (+48VDC optional) 1 x SATA power header 1 x System fan header 1 x Front panel header 1 x Front panel audio header 1 x 2W Speaker out header 4 x USB 2.0 headers 2 x COM headers (RS-232) 1 x COM header (RS-232/422/485 & RI/5V/12V) 1 x Backlight Control header 1 x AT/ATX mode select jumper 1 x GPIO (8 bits) & SMBUS header 1 x Buzzer header
Rear I/O	1 x Headphone Jack 1 x HDMI 1 x VGA 2 x RJ45 LAN ports 2 x USB 3.0	1 x Headphone Jack 1 x HDMI 1 x VGA 2 x RJ45 LAN ports 2 x USB 3.0	1 x Headphone Jack 1 x HDMI 1 x VGA 2 x RJ45 LAN ports 1 x USB 2.0 1 x USB 3.0
TPM	1 x TPM header	1 x TPM header	1 x TPM header
Operating Temp.	0°C to 60°C	0°C to 60°C	0°C to 60°C
Ordering Information	9MZAPLCSMR-SI (Box packing) (QBiP-4200B) 9MZAPLDSMR-SI (Box packing) (QBiP-4200C) 9MZAPLESMSR-SI (Box packing) (QBiP-3350A)	9MAPLKASMR-SI (Box packing)	9MBAYTASMR-SI (Box packing)
Heatsink P/N	25ST1-153109-A7R	25ST1-113103-A7R	25ST1-153107-A7R
Fan Module P/N	—	—	—
Heat Spreader P/N	25ST5-CBAB00-A8R	—	25ST5-CBAB00-A8R

QBiP Series (3.5" SBC)

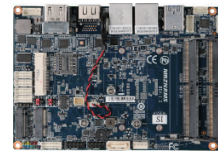
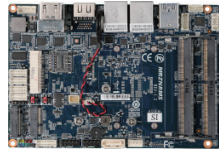

QBiP Series (3.5" SBC)

Model Name	QBiP-1605A	QBiP-1606A
CPU	AMD® RYZEN™ Embedded V1605B, 14nm, 4 cores, 8 threads, 2.0 GHz, up to 3.6 GHz, TDP 25W	AMD® RYZEN™ Embedded R1606G, 14nm, 2 cores, 4 threads, 2.6 GHz, up to 3.5 GHz, TDP 25W
Socket	FP5 type 1	FP5 type 1
Chipset	SoC	SoC
Memory	2 x DDR4 SO-DIMM sockets, Max. Capacity 32 GB, Support Dual Channel DDR4 2400/2133MHz	2 x DDR4 SO-DIMM sockets, Max. Capacity 32 GB, Support Dual Channel DDR4 2400/2133 MHz
Ethernet	2 x GbE LAN ports (Realtek® RTL8111HS)	2 x GbE LAN ports (Realtek® RTL8111HS)
Graphic	Integrated Graphics Processor - AMD® Radeon™ Vega 8 Graphics: 4 x HDMI 2.0, 1 x eDP (share from HDMI) 4 independent display outputs	Integrated Graphics Processor - AMD® Radeon™ Vega 3 Graphics: 3 x HDMI 2.0, 1 x eDP (share from HDMI) 3 independent display outputs
Audio	Realtek® Audio Codec	Realtek® Audio Codec
Storage	1 x SATA 6Gb/s port	1 x SATA 6Gb/s port
Expansion Slots	1 x 2280 M.2 M-Key (PCIe x4, SATA 6Gb/s) 1 x 2230 M.2 E-Key 1 x Full-size Mini PCIe with SIM slot	1 x 2280 M.2 M-Key (PCIe x4, SATA 6Gb/s) 1 x 2230 M.2 E-Key 1 x Full-size Mini PCIe with SIM slot
Internal I/O	1 x 4-pin box power connector (+9V~36VDC) 1 x SATA power header 1 x CPU fan header 1 x System fan header 1 x Front panel header 1 x Front panel audio header 1 x 2W Speaker out header 4 x USB 2.0 headers 2 x COM headers (RS-232) 2 x COM headers (RS-232/422/485 & RI/5V/12V) 1 x Backlight Control header 1 x AT/ATX mode select jumper 1 x eDP/HDMI jumper 1 x GPIO (8 bits) & SMBUS header 1 x Buzzer	1 x 4-pin box power connector (+9V~36VDC) 1 x SATA power header 1 x CPU fan header 1 x System fan header 1 x Front panel header 1 x Front panel audio header 1 x 2W Speaker out header 4 x USB 2.0 headers 2 x COM headers (RS-232) 2 x COM headers (RS-232/422/485 & RI/5V/12V) 1 x Backlight Control header 1 x AT/ATX mode select jumper 1 x eDP/HDMI jumper 1 x GPIO (8 bits) & SMBUS header 1 x Buzzer
Rear I/O	4 x HDMI 2 x RJ45 LAN ports 2 x USB 3.0	3 x HDMI 2 x RJ45 LAN ports 2 x USB 3.0
TPM	Onboard TPM 2.0 security chip INFINEON SLB9665TT2.0	Onboard TPM 2.0 security chip INFINEON SLB9665TT2.0
Operating Temp.	0°C to 60°C	0°C to 60°C
Ordering Information	9MRZNVMSNR-SI (Bulk packing) 9MRZNVMSMR-SI (Box packing)	9MRZNRMSMR-SI (Box packing)
Heatsink P/N	25ST1-113104-A7R	TBD
Fan Module P/N	12SF2-01A073-00R	12SF2-01A073-00R
Heat Spreader P/N	25ST5-QP1600-A8R	TBD

QBiP Wide Temperature Series

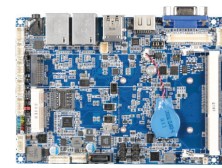
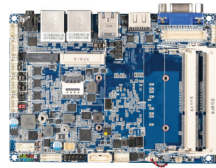
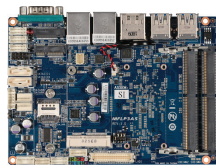

Model Name	QBiP-7200AT/ QBiP-7100AT	QBiP-E3940AT	QBiP-1900AT
CPU	Intel® Core™ i5-7200U Processor, 14nm, 2 cores, 4 threads, up to 3.1GHz, TDP 15W (QBiP-7200AT) Intel® Core™ i3-7100U Processor, 14nm, 2 cores, 4 threads, up to 2.4GHz, TDP 15W (QBiP-7100AT)	Intel® Atom® x5-E3940 Processor, 14nm, 4 cores, 4 threads, up to 1.8 GHz, TDP 9.5W	Intel® Celeron® J1900 Processor, 22nm, 4 cores, 4 threads, up to 2.42 GHz, TDP 10W
Socket	FCBGA1356	FCBGA1296	FCBGA1170
Chipset	SoC	SoC	SoC
Memory	2 x DDR4 SO-DIMM sockets, Max. Capacity 32 GB, Support Dual Channel DDR4 2133 MHz	2 x DDR3L SO-DIMM sockets, Max. Capacity 8 GB, Support Dual Channel DDR3L 1866 MHz	1 x DDR3L SO-DIMM socket, Max. Capacity 8 GB, Support Single Channel DDR3L 1333 MHz
Ethernet	2 x GbE LAN ports (Intel® I219V and Intel® I211AT)	2 x GbE LAN ports (Intel® I211AT)	2 x GbE LAN ports (Intel® I211AT)
Graphic	Integrated Graphics Processor - Intel® HD Graphics 620: 1 x HDMI 2.0, 1 x Display Port 1 x LVDS 3 independent display outputs	Integrated Graphics Processor - Intel® HD Graphics 500: 1 x HDMI 1.4, 1 x VGA, 1 x LVDS 3 independent display outputs	Integrated Graphics Processor - Intel® HD Graphics: 1 x HDMI 1.4, 1 x VGA, 1 x LVDS 2 independent display outputs
Audio	Realtek® Audio Codec	Realtek® Audio Codec	Realtek® Audio Codec
Storage	2 x SATA 6Gb/s ports (RAID 0/1/5)	1 x SATA 6Gb/s port	1 x SATA 3Gb/s port
Expansion Slots	1 x 2280 M.2 M-Key (PCIe x4, SATA 6Gb/s) 1 x 2230 M.2 E-Key 1 x Full-size Mini PCIe with SIM slot	1 x 2242 M.2 M-Key (SATA 6Gb/s) 1 x Full-size Mini PCIe with SIM slot	1 x 2280 M.2 M-Key (SATA 3Gb/s) 1 x Full-size Mini PCIe with SIM slot
Internal I/O	1 x 4-pin box power connector (+9V~36VDC) 2 x SATA power headers 1 x CPU fan header 1 x System fan header 1 x Front panel header 1 x Front panel audio header 1 x 2W Speaker out header 2 x USB 2.0 headers 3 x COM headers (RS-232) 1 x Backlight Control header 1 x AT/ATX mode select jumper 1 x GPIO (8 bits) & SMBUS header	1 x 4-pin box power connector (+9V~36VDC) 1 x SATA power header 1 x System fan header 1 x Front panel header 1 x Front panel audio header 1 x 2W Speaker out header 4 x USB 2.0 headers 3 x COM headers (RS-232) 1 x COM header (RS-232/422/485 & RI/5V/12V) 1 x Backlight Control header 1 x AT/ATX mode select jumper 1 x GPIO (8 bits) & SMBUS header 1 x Buzzer header	1 x 4-pin box power connector (+9V~36VDC) (+48VDC optional) 1 x SATA power header 1 x System fan header 1 x Front panel header 1 x Front panel audio header 1 x 2W Speaker out header 4 x USB 2.0 headers 2 x COM headers (RS-232) 1 x COM header (RS-232/422/485 & RI/5V/12V) 1 x Backlight Control header 1 x AT/ATX mode select jumper 1 x GPIO (8 bits) & SMBUS header 1 x Buzzer header
Rear I/O	1 x COM port (RS-232/422/485 & RI/5V/12V) 1 x HDMI, 1 x Display Port 2 x RJ45 LAN ports 4 x USB 3.0	1 x Headphone Jack 1 x HDMI 1 x VGA 2 x RJ45 LAN ports 2 x USB 3.0	1 x Headphone Jack 1 x HDMI, 1 x VGA 2 x RJ45 LAN ports 1 x USB 2.0 1 x USB 3.0
TPM	1 x TPM header	1 x TPM header	1 x TPM header
Operating Temp.	-20°C to 70°C	-40°C to 85°C	-40°C to 85°C
Ordering Information	9MFLP5ASMR-SI1 (Box packing) (QBiP-7200AT) 9MFLP3ASMR-SI1 (Box packing) (QBiP-7100AT)	9MAPLKASMR-SI1 (Box packing)	9MBAYTASMR-SI1 (Box packing)
Heatsink P/N	25ST1-153108-A7R	25ST1-113103-A7R	25ST1-153107-A7R
Fan Module P/N	12SF2-01A073-00R	—	—
Heat Spreader P/N	25ST5-CKAC00-A8R	—	25ST5-CBAB00-A8R

QBi Series (10 x 10 Embedded Compact Board)

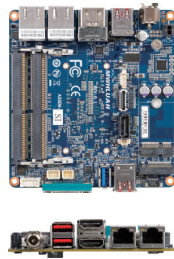

QBi Series (10 x 10 Embedded Compact Board)

Model Name	QBi-8565A/ QBi-8265A/ QBi-8145A	QBi-7100B	QBi-3965B
CPU	Intel® Core™ i7-8565U Processor, 14nm, 4 cores, 8 threads, up to 4.6 GHz, TDP 15W (QBi-8565A) Intel® Core™ i5-8265U Processor, 14nm, 4 cores, 8 threads, up to 3.9 GHz, TDP 15W (QBi-8265A) Intel® Core™ i3-8145UE Processor, 14nm, 2 cores, 4 threads, up to 3.9 GHz, TDP 15W (QBi-8145A)	Intel® Core™ i3-7100U Processor, 14nm, 2 cores, 4 threads, 2.4 GHz, TDP 15W	Intel® Celeron® 3965U Processor, 14nm, 2 cores, 2 threads, 2.2 GHz, TDP 15W
Socket	FCBGA1528	FCBGA1356	FCBGA1356
Chipset	—	—	—
Memory	2 x DDR4 SO-DIMM sockets, Max. Capacity 32 GB, Support Dual Channel DDR4 2400 MHz	2 x DDR4 SO-DIMM sockets, Max. Capacity 32 GB, Support Dual Channel DDR4 2133 MHz	2 x DDR4 SO-DIMM sockets, Max. Capacity 32 GB, Support Dual Channel DDR4 2133 MHz
Ethernet	2 x GbE LAN ports (Intel® I219V and Realtek® RTL8111HS)	1 x GbE LAN port (Intel® I219V)	1 x GbE LAN port (Intel® I219V)
Graphic	Integrated Graphics Processor - Intel® UHD Graphics 620: 2 x HDMI 1.4 1 x eDP 3 independent display outputs	Integrated Graphics Processor - Intel® HD Graphics 620: 1 x HDMI 2.0 1 x Mini Display Port 1 x eDP 3 independent display outputs	Integrated Graphics Processor - Intel® HD Graphics 620: 1 x HDMI 2.0 1 x Mini Display Port 1 x eDP 3 independent display outputs
Audio	Realtek® Audio Codec	Intel® Integrated Audio	Intel® Integrated Audio
Storage	1 x SATA 6Gb/s ports (RAID 0/1)	1 x SATA 6Gb/s port (RAID 0/1)	1 x SATA 6Gb/s port
Expansion Slots	1 x 2280 M.2 M-Key (PCIe x4, SATA 6Gb/s) 1 x 2230 M.2 E-Key	1 x 2280 M.2 M-Key (PCIe x4, SATA 6Gb/s) 1 x 2230 M.2 E-Key	1 x 2280 M.2 M-Key (SATA 6Gb/s) 1 x 2230 M.2 E-Key
Internal I/O	1 x 2-pin power connector 1 x SATA/eDP power header 1 x CPU fan header 1 x Front panel header 1 x Front panel audio header/ GPIO (8 bits) & SMBUS header 1 x USB 2.0 header 1 x Vertical USB 3.0 (Flexible to PCIe x1)	1 x 2-pin power connector 1 x SATA power header 1 x CPU fan header 1 x Front panel header 2 x USB 2.0 headers 1 x USB 3.0 header 1 x COM header (RS-232)	1 x 2-pin power connector 1 x SATA power header 1 x CPU fan header 1 x Front panel header 2 x USB 2.0 headers 1 x USB 3.0 header 1 x COM header (RS-232)
Front IO	2 x USB 3.1 Gen2 1 x Power button 1 x COM port (RS-232/422/485)	2 x USB 3.0 1 x Power button	2 x USB 3.0 1 x Power button
Rear IO	2 x HDMI 2 x RJ45 LAN ports 2 x USB 3.1 Gen2 1 x Screw type DC Jack (+9V~36VDC)	1 x HDMI 2.0 1 x Mini Display Port 1 x RJ45 LAN port 2 x USB 3.0 1 x DC Jack (+12V~24VDC)	1 x HDMI 2.0 1 x Mini Display Port 1 x RJ45 LAN port 2 x USB 3.0 1 x DC Jack (+12V~24VDC)
Side IO	—	—	—
TPM	—	—	—
Operating Temp.	0°C to 60°C	0°C to 60°C	0°C to 60°C
Ordering Information	9MWHLUAHMR-SI (Box packing) (QBi-8565A) 9MWHLUBHMR-SI (Box packing) (QBi-8265A) 9MWHLUCHMR-SI (Box packing) (QBi-8145A)	9MFLP3AHNR-SI (Bulk packing)	9MFLPCAHR-SI (Box packing)
Heatsink P/N	—	—	—
Fan Module P/N	—	25ST4-343202-C1R	25ST4-343202-C1R
Heat Spreader P/N	—	25ST5-CKAA01-A8R	25ST5-CKAA01-A8R

QBi Series (10 x 10 Embedded Compact Board)

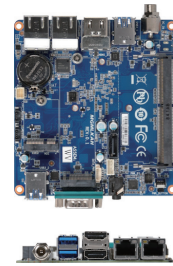

Model Name	QBi-5005A/ QBi-5005B/ QBi-4000B	QBi-4200A/ QBi-4200B	QBi-4125A
CPU	Intel® Pentium® Silver J5005 Processor, 4 cores, 4 threads, up to 2.80 GHz, TDP 10W (QBi-5005A/ QBi-5005B) Intel® Celeron® N4000 Processor, 2 Cores, 2 threads, up to 2.60 GHz, TDP 6W (QBi-4000B)	Intel® Pentium® N4000 Processor, 14nm, 4 cores, 4 threads, up to 2.5 GHz, TDP 6W	Intel® Pentium® Silver J4125 Processor, 14nm, 4 cores, 4 threads, up to 2.7 GHz, TDP 10W
Socket	FCBGA1090	FCBGA1296	FCBGA1090
Chipset	—	—	SoC
Memory	1 x DDR4 SO-DIMM socket, Max. Capacity 8 GB, Support Single Channel DDR4 2400 MHz	1 x DDR3L SO-DIMM socket, Max. Capacity 8 GB, Support Single Channel DDR3L 1866 MHz	1 x DDR4 SO-DIMM socket, Max. Capacity 8 GB, Support Single Channel DDR4 2400 MHz
Ethernet	1 x GbE LAN port (Realtek® RTL8111HS)	1 x GbE LAN port (Realtek® RTL8111HS)	2 x GbE LAN ports (Intel® I211AT and Realtek®RTL8111HS)
Graphic	QBi-5005A/ 5005B: Integrated Graphics Processor - Intel® UHD Graphics 605: QBi-4000B: Integrated Graphics Processor - Intel® UHD Graphics 600: 1 x HDMI 1.4, 1 x VGA, 1 x eDP 3 independent display outputs	Integrated Graphics Processor - Intel® HD Graphics 505: 1 x HDMI 1.4 1 x VGA 1 x eDP 3 independent display outputs	Integrated Graphics Processor - Intel® UHD Graphics 605: 2 x HDMI 1.4 1 x eDP 3 independent display outputs
Audio	Realtek® Audio Codec	Realtek® Audio Codec	Realtek® Audio Codec
Storage	1 x SATA 6Gb/s port (7-pin) 1 x SATA 6Gb/s port (FFC) 1 x eMMC 32GB (5005A only)	1 x SATA 6Gb/s port 1 x eMMC 32GB (4200A only)	1 x 2.5" HDD/SSD (SATA 6Gb/s)
Expansion Slots	1 x 2230 M.2 E-Key	1 x 2230 M.2 E-Key	1 x 2280 M.2 M-Key (SATA 6Gb/s) 1 x 2230 M.2 E-Key
Internal I/O	1 x 2-pin power connector (Optional) 1 x SATA power header 1 x CPU fan header 1 x Front panel header 2 x USB 2.0 headers	1 x 2-pin power connector 1 x SATA power header 1 x CPU fan header 1 x Front panel header 2 x USB 2.0 headers 1 x USB 3.0 header 1 x COM header (RS-232)	1 x 2-pin power connector 1 x SATA power header 1 x CPU fan header 1 x Front panel header 2 x USB 2.0 headers 1 x Speaker out header
Front IO	2 x USB 3.0 1 x Power button 1 x COM port (RS-232) 1 x Headphone Jack 1 x Microphone Jack	2 x USB 3.0 1 x Power button 1 x Audio Combo Jack (Headphone & Microphone)	2 x USB 3.0 1 x COM (RS-232) 1 x Headphone Jack 1 x Power button
Rear IO	1 x HDMI, 1 x VGA 1 x RJ45 LAN port 2 x USB 3.0	1 x HDMI, 1 x VGA 1 x RJ45 LAN port 2 x USB 3.0	2 x RJ45 LAN ports 2 x USB 3.0, 2 x HDMI 1 x DC Jack (+12V~19VDC)
Side IO	1 x DC Jack (+12V~19VDC)	1 x DC Jack (+12V~24VDC)	—
TPM	—	—	—
Operating Temp.	0°C to 60°C	0°C to 60°C	0°C to 60°C
Ordering Information	9MZGLKAHNR-SI (Bulk packing) (QBi-5005A) 9MZGLKCHMR-SI (Box packing) (QBi-5005B) 9MZGLKBHMR-SI (Box packing) (QBi-4000B)	9MZAPLAHNR-SI (Bulk packing) (QBi-4200A) 9MZAPLBHMR-SI (Box packing) (QBi-4200B)	9MGMLKAHMR-SI (Box packing) (QBi-4125A)
Heatsink P/N	12SP2-090019-00R	12SP2-090018-00R	12SP2-090018-00R
Fan Module P/N	—	—	TBD
Heat Spreader P/N	25ST5-CGAA00-A8R	25ST5-CGAA00-A8R	25ST5-CGAA00-A8R

GIGAIPC

GIGABYTE™ G R O U P

Building
a **SMARTER** Tomorrow



GIGAIPC

GIGAIPC CO., LTD.
GIGABYTE TECHNOLOGY GROUP

B1-A, No.205, Sec. 3, Beixin Rd., Xindian Dist.,
New Taipei City 23143, Taiwan (R.O.C)

TEL: +886-2-89131312 FAX: +886-2-89131332
Email: sales@gigaipc.com URL: www.gigaipc.com

技宸股份有限公司
技嘉集團

新北市 231 新店區北新路三段 205 號 B1-A

TEL: +886-2-89131312 FAX: +886-2-89131332
Email: sales@gigaipc.com URL: www.gigaipc.com



GMKT-C2021000