

# QBi-7100B (MFLP3AH)

---

10" x 10" Embedded Compact Board  
User's Manual 1st Ed

## Copyright Notice

---

This document is copyrighted, 2018. All rights are reserved. The original manufacturer reserves the right to make improvements to the products described in this manual at any time without notice.

No part of this manual may be reproduced, copied, translated, or transmitted in any form or by any means without the prior written permission of the original manufacturer. Information provided in this manual is intended to be accurate and reliable. However, the original manufacturer assumes no responsibility for its use, or for any infringements upon the rights of third parties that may result from its use.

The material in this document is for product information only and is subject to change without notice. While reasonable efforts have been made in the preparation of this document to assure its accuracy, GIGAIPC assumes no liabilities resulting from errors or omissions in this document, or from the use of the information contained herein.

GIGAIPC reserves the right to make changes in the product design without notice to its users.

## Acknowledgement

---

All other products' name or trademarks are properties of their respective owners.

- AMD® is trademark of Advanced Micro Devices.
- Microsoft Windows is a registered trademark of Microsoft Corp.
- Intel, Pentium, Celeron, and Xeon are registered trademarks of Intel Corporation
- Core, Atom are trademarks of Intel Corporation
- ITE is a trademark of Integrated Technology Express, Inc.
- IBM, PC/AT, PS/2, and VGA are trademarks of International Business Machines Corporation.

All other product names or trademarks are properties of their respective owners.

# Packing List

---

Before setting up your product, please make sure the following items have been shipped:

Item	Quantity
QBi-7100B	1
SATA power cable, 150 mm	1
SATA FFC cable, 100 mm	1

If any of these items are missing or damaged, please contact your distributor or sales representative immediately.

## About this Document

---

This User's Manual contains all the essential information, such as detailed descriptions and explanations on the product's hardware and software features (if any), its specifications, dimensions, jumper/connector settings/definitions, and driver installation instructions (if any), to facilitate users in setting up their product.

Users may refer to the [GIGAIPC.com](http://GIGAIPC.com) for the latest version of this document.

## Safety Precautions

---

Please read the following safety instructions carefully. It is advised that you keep this manual for future references

1. All cautions and warnings on the device should be noted.
2. Make sure the power source matches the power rating of the device.
3. Position the power cord so that people cannot step on it. Do not place anything over the power cord.
4. Always completely disconnect the power before working on the system's hardware.
5. No connections should be made when the system is powered as a sudden rush of power may damage sensitive electronic components.
6. If the device is not to be used for a long time, disconnect it from the power supply to avoid damage by transient over-voltage.
7. Always disconnect this device from any AC supply before cleaning.
8. While cleaning, use a damp cloth instead of liquid or spray detergents.
9. Make sure the device is installed near a power outlet and is easily accessible.
10. Keep this device away from humidity.
11. Place the device on a solid surface during installation to prevent falls
12. Do not cover the openings on the device to ensure optimal heat dissipation.

13. Watch out for high temperatures when the system is running.
14. Do not touch the heat sink or heat spreader when the system is running
15. Never pour any liquid into the openings. This could cause fire or electric shock.
16. As most electronic components are sensitive to static electrical charge, be sure to ground yourself to prevent static charge when installing the internal components. Use a grounding wrist strap and contain all electronic components in any static-shielded containers.
17. If any of the following situations arises, please the contact our service personnel:
  - i. Damaged power cord or plug
  - ii. Liquid intrusion to the device
  - iii. Exposure to moisture
  - iv. Device is not working as expected or in a manner as described in this manual
  - v. The device is dropped or damaged
  - vi. Any obvious signs of damage displayed on the device
- 18. DO NOT LEAVE THIS DEVICE IN AN UNCONTROLLED ENVIRONMENT WITH TEMPERATURES BEYOND THE DEVICE'S PERMITTED STORAGE TEMPERATURES (SEE CHAPTER 1) TO PREVENT DAMAGE.**

## FCC Statement

---

### **Warning!**



This device complies with Part 15 FCC Rules. Operation is subject to the following two conditions: (1) this device may not cause harmful interference, and (2) this device must accept any interference received including interference that may cause undesired operation.

### **Caution:**

*There is a danger of explosion if the battery is incorrectly replaced. Replace only with the same or equivalent type recommended by the manufacturer. Dispose of used batteries according to the manufacturer's instructions and your local government's recycling or disposal directives.*

### **Attention:**

*Il y a un risque d'explosion si la batterie est remplacée de façon incorrecte. Ne la remplacer qu'avec le même modèle ou équivalent recommandé par le constructeur. Recycler les batteries usées en accord avec les instructions du fabricant et les directives gouvernementales de recyclage.*



## China RoHS Requirements (CN)

产品中有毒有害物质或元素名称及含量

GIGAIPC Main Board/ Daughter Board/ Backplane

部件名称	有毒有害物质或元素					
	铅 (Pb)	汞 (Hg)	镉 (Cd)	六价铬 (Cr(VI))	多溴联苯 (PBB)	多溴二苯醚 (PBDE)
印刷电路板 及其电子组件	○	○	○	○	○	○
外部信号 连接器及线材	○	○	○	○	○	○

○: 表示该有毒有害物质在该部件所有均质材料中的含量均在 SJ/T 11363-2006 标准规定的限量要求以下。

X: 表示该有毒有害物质至少在该部件的某一均质材料中的含量超出 SJ/T 11363-2006 标准规定的限量要求。

备注: 此产品所标示之环保使用期限, 系指在一般正常使用状况下。

## China RoHS Requirement (EN)

### Poisonous or Hazardous Substances or Elements in Products GIGAIPC Main Board/ Daughter Board/ Backplane

Component	Poisonous or Hazardous Substances or Elements					
	Lead (Pb)	Mercury (Hg)	Cadmium (Cd)	Hexavalent Chromium (Cr(VI))	Polybrominated Biphenyls (PBB)	Polybrominated Diphenyl Ethers (PBDE)
PCB & Other Components	O	O	O	O	O	○
Wires & Connectors for External Connections	O	O	O	O	O	O

O : The quantity of poisonous or hazardous substances or elements found in each of the component's parts is below the SJ/T 11363-2006-stipulated requirement.  
X: The quantity of poisonous or hazardous substances or elements found in at least one of the component's parts is beyond the SJ/T 11363-2006-stipulated requirement.  
Note: The Environment Friendly Use Period as labeled on this product is applicable under normal usage only

## Table Contents

<b>10" x 10" Embedded Compact Board</b>	<b>1</b>
<b>User's Manual 1st Ed</b>	<b>1</b>
Copyright Notice .....	2
Acknowledgement .....	3
Packing List.....	4
About this Document .....	5
Safety Precautions .....	6
FCC Statement.....	8
China RoHS Requirements (CN).....	9
China RoHS Requirement (EN) .....	10
<b>Chapter1 - Product Specifications</b>	<b>13</b>
1.1 Specifications- QBi-7100B (MFLP3AH) .....	15
<b>Chapter 2 – Hardware Information</b>	<b>17</b>
2.1 Jumpers and Connectors .....	18
2.2.1 BATTERY (Battery Cable connector) .....	21
2.2.2 CPU FAN (CPU FAN connector) .....	22
2.2.3 EDP (Embedded Display Port Connector).....	23
2.2.4 ATX IN .....	24
2.2.5 BKL_SEL (Back light brightness control connector) .....	25
2.2.6 F_PANEL (Front panel header) .....	26
2.2.7 F_USB3_1 (Front USB 3.1 connector) .....	27

2.2.8	COM (Serial Port header).....	28
2.2.9	F_USB2_1, F_USB2_2 (USB 2.0 header) .....	29
2.2.10	SATA_PWR_0 (SATA 6Gb/s power connector).....	30
2.2.11	SATA0 (SATA 6Gb/s connector) .....	31

# Chapter 1

---

## Chapter1 - Product Specifications QBi-7100B (MFLP3AH)

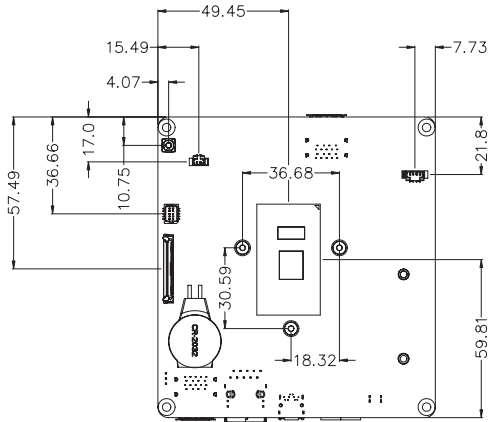
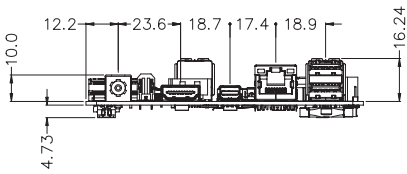
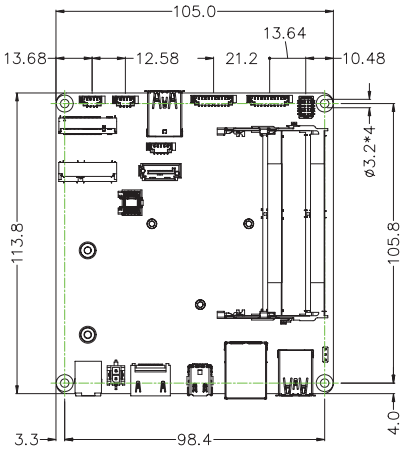
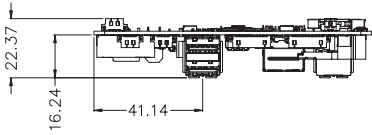

## 1.1 Specifications- QBi-7100B (MFLP3AH)

Motherboard	QBi-7100B (MFLP3AH)
Form Factor	Embedded Compact Board 105W x 110D mm
CPU	Intel® Core™ i3-7100U Processor 14nm, 2 cores, 4 threads 2.40 GHz TDP 15W 3 MB Smart Cache
Socket	1 x FCBGA1356
Chipset	—
Memory	2 x DDR4 SO-DIMM sockets, Max. Capacity 32 GB Dual channel memory architecture Support for DDR4 2133 MHz memory modules
Ethernet	1 x GbE LAN port (Intel® i219V)
Video	Integrated Graphics Processor - Intel® HD Graphics 620 support 1 x HDMI2.0 port, supporting a maximum resolution of 4096 x 2160@60 Hz 1 x mini DP port, supporting a maximum resolution of 4096 x 2160@60 Hz 1 x eDP port, supporting a maximum resolution of 3840 x 2160 @ 60Hz
Audio	Intel® integrated Audio
Storage	1 x SATA 6Gb/s port
Raid	—
Expansion Slots	1 x M.2 slot: - M-key - SATA 6Gb/s / PCIe X4 - Supports NGFF-2280 cards 1 x M.2 slot: - E-key - Supports NGFF-2230 (WiFi/BT)

Motherboard	QBi-7100B (MFLP3AH)
Internal I/O	1 x 2 pin power connector 1 x SATA 6Gb/s connector 1 x CPU fan header 2 x USB 2.0/1.1 headers 1 x USB3.0 header 1 x COM header(RS232) 1 x LPC header 1 x Front panel header
Front IO	2 x USB3.0
Rear IO	1 x HDMI 1 x Mini Display 1 x RJ45 2 x USB3.0 1 x DC_IN Jack ( 12~24V )
Side IO	—
TPM	—
OS Compatibility	Windows 10 (x64)
PSU Connectors	1 x 12~24V DC-in 1 x 2-pin Box header power connector (12~24V)
Operating Properties	Operating temperature: 0°C to 60°C Operating humidity: 0-90% (non-condensing) Non-operating temperature: -20°C to 70°C Non-operating humidity: 0%-95% (non-condensing)



# Chapter 2

---

## Chapter 2 – Hardware Information

# 2.1 Jumpers and Connectors

---

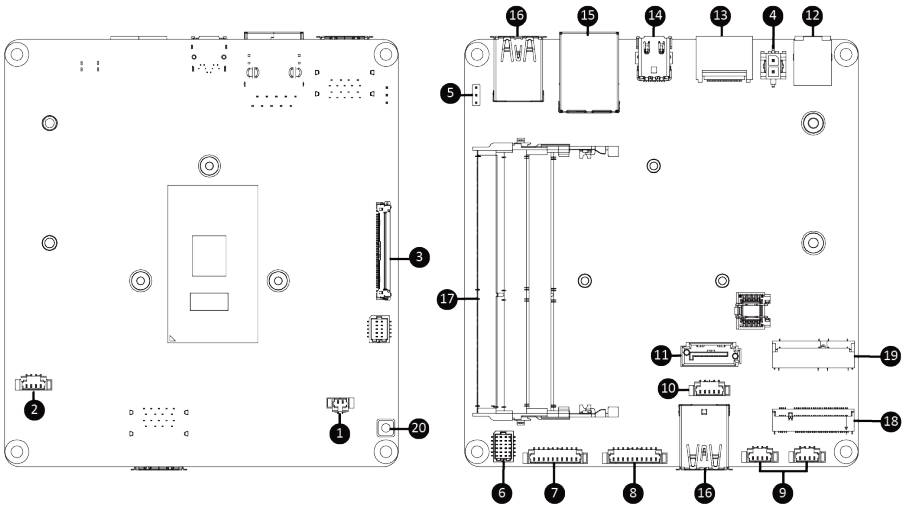

No	Code	Description
1	BATTERY	Battery cable connector
2	CPU_FAN	CPU FAN connector
3	EDP	Embedded Display Port Connector
4	ATX_IN	
5	BKL_SEL	Back light brightness control connector
6	F_PANEL	Front panel connector
7	F_USB3_1	Front USB 3.1 connector
8	COM	Serial port connector
9	F_USB2_1 F_USB2_2	USB 2.0 header
10	SATA_PWR_0	SATA 6Gb/s power connector
11	SATA0	SATA 6Gb/s connector
12	DC_IN	DC in Jack
13	HDMI20	HDMI 2.0 Port
14	MDP	Mini Display
15	LAN	GbE LAN Port

No	Code	Description
16	F_USB3_1	Front USB 3.0 connector
17	SODIMM1 SODIMM2	2 x DDR4 SO-DIMM sockets, Max. Capacity 32 GB. Support Dual Channel DDR4 2133 MHz memory modules
18	M2M	2280 M.2 M-Key (SATA 6Gb/s)
19	M2E	2230 M.2 E-Key
20	Power Button	Power Switch

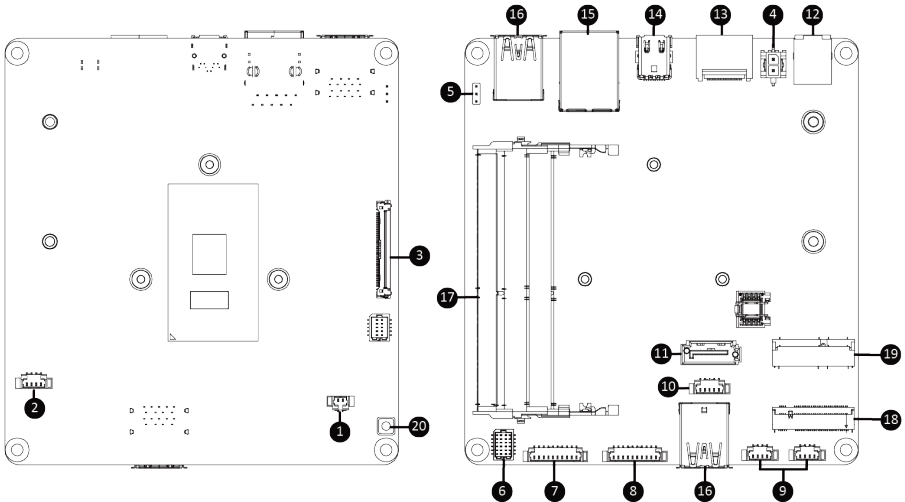

## 2.2.1 BATTERY (Battery Cable connector)

1

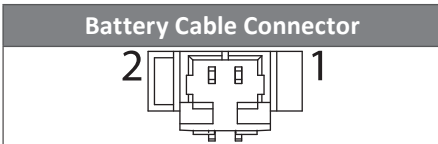
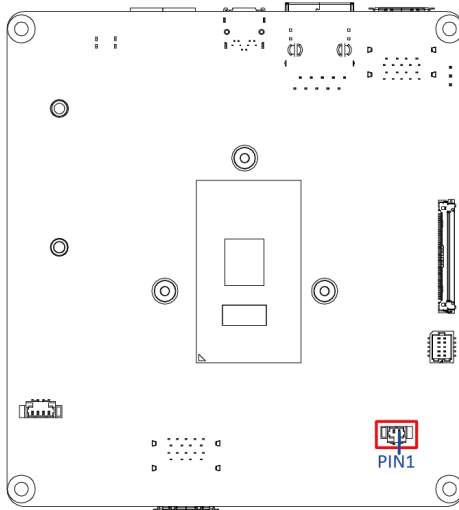

Connector PN	Vendor
85205-0270L	ACES
A1250WV-S-02PC	JOINT-TECH

Pin No.	Definition
1	3.3V
2	GND

## 2.2.2 CPU FAN (CPU FAN connector)

2

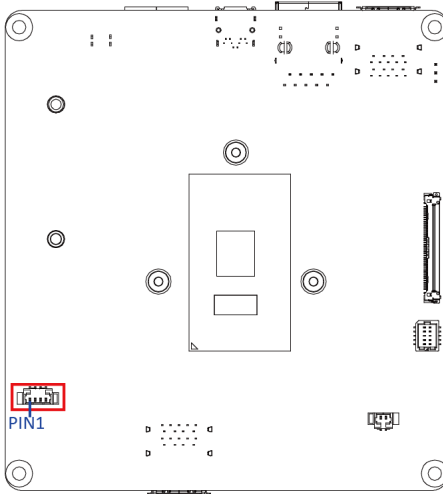

**CPU FAN connector**

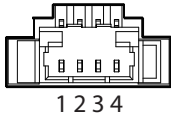

**Connector PN**

85205-0470N

A1250WV-S-04PC

**Vendor**

ACES

JOINT-TECH

**Pin No.**

**Definition**

1	GND
2	+V5S
3	TACH_PWRFAN1
4	PWM_PWMFAN1

## 2.2.3 EDP (Embedded Display Port Connector)

**3**

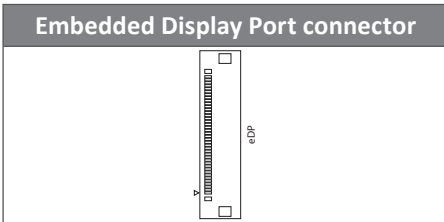
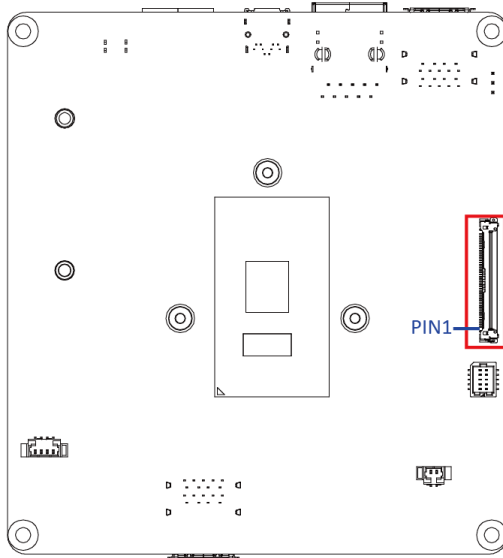

Pin No.	Definition	Pin No.	Definition
1	NC	21	+LCD_VCC (5V)
2	GND	22	NC
3	EDP_LANN3	23	GND
4	EDP_LANP3	24	GND
5	GND	25	GND
6	EDP_LANN2	26	GND
7	EDP_LANP2	27	EDP_HPDI_3V3
8	GND	28	GND
9	EDP_LANN1	29	GND
10	EDP_LANP1	30	GND
11	GND	31	GND
12	EDP_LANNO	32	EDP_BKLTEN_3V3

Pin No.	Definition	Pin No.	Definition
13	EDP_LANP0	33	EDP_BKLCTL_3V3
14	GND	34	NC
15	EDP_AUX_C_DP	35	NC
16	EDP_AUX_C_DN	36	+BL_PWR (10V or DCIN)
17	GND	37	+BL_PWR (10V or DCIN)
18	+LCD_VCC (5V)	38	+BL_PWR (10V or DCIN)
19	+LCD_VCC (5V)	39	+BL_PWR (10V or DCIN)
20	+LCD_VCC (5V)	40	NC

Note: Please ensure pin 8 is connected to Ground.

Connector PN	Vendor
20455-040E-12	I-PEX

## 2.2.4 ATX IN

4

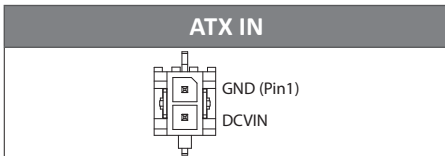
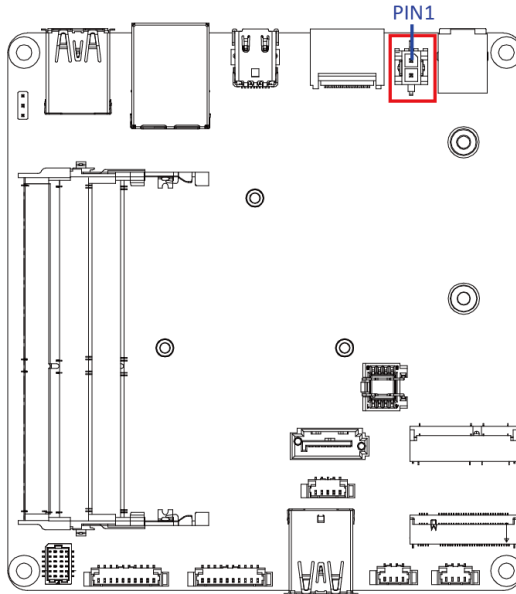

Connector PN	Vendor
99-01740-B004-A	TCONN

Pin No.	Definition
1	GND (Pin1)
2	DCVIN



## 2.2.5 BKL\_SEL (Back light brightness control connector)

5

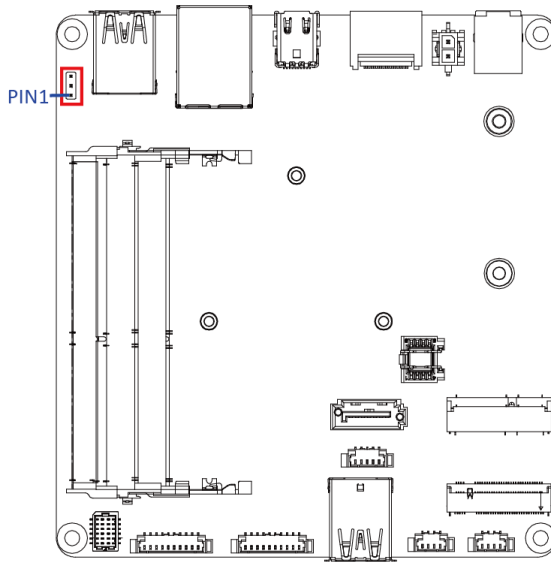

Back light brightness control connector

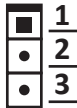

Pin No.	Definition
1	VIN
2	+BL_PWR_Q
3	VIN_10V

Connector PN

222-96-03GBE1

PH03N33BAAA00

Vendor

PINREX

HORNGTONG

Jumper

DCIN(12V-24V)

10V Fix

1-2

2-3 (Default)

## 2.2.6 F\_PANEL (Front panel header)

6

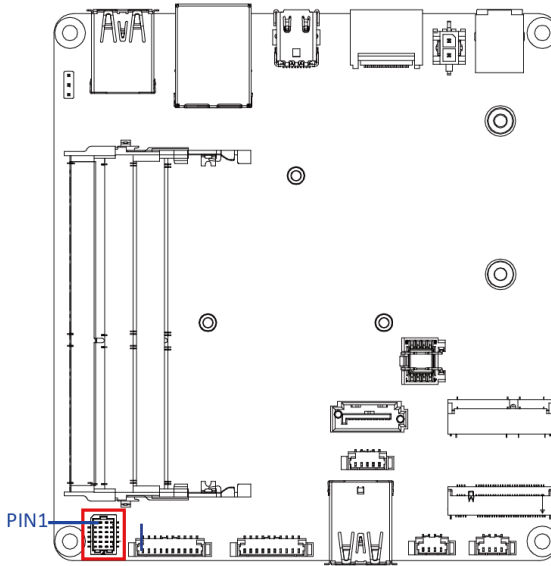

Front Panel Connector

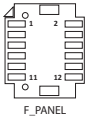

Connector PN

87216-1206-06

Vendor

ACES

Pin No.	Definition
1	SATA_LED_P
2	MPD_+
3	GND (SATA_LEN_N)
4	MPD-
5	GND
6	-PANSHW (Power BTN)
7	PMU_RSTBTN_N (Reset BTN)
8	GND
9	+V5S
10	+V3.3A
11	+V5A
12	NC

## 2.2.7 F\_USB3\_1 (Front USB 3.1 connector)

7

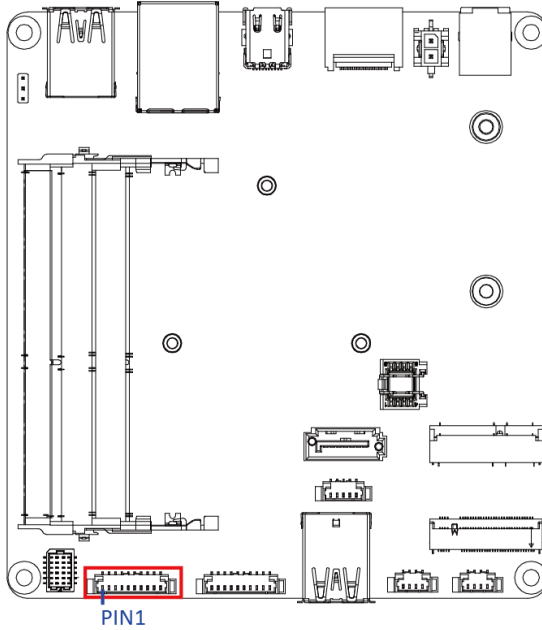

USB 3.0 connector	

Connector PN	Vendor
DF13C-10P-1.25V(51)	HRS
85205-10701	ACES

Pin No.	Definition
1	VCC
2	D-
3	D+
4	GND
5	TXN
6	TXP
7	GND
8	RXN
9	RXP
10	NC

## 2.2.8 COM (Serial Port header)

8

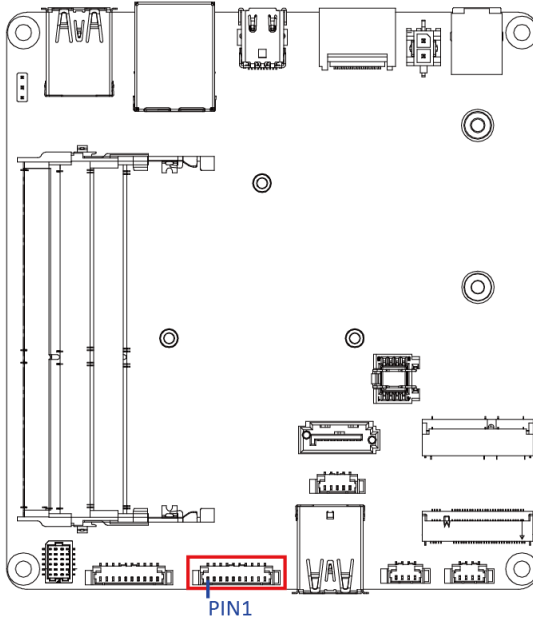

Serial Port Cable Connector

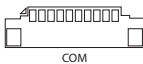

Connector PN

DF13C-10P-1.25V(51)

Vendor

HRS

85205-10701

ACES

Pin No.	Definition
1	NDCDA-
2	NRXDA-
3	NTXDA-
4	NDTRA-
5	GND
6	NDSRA-
7	NRTSA-
8	NCTSA-
9	NRIA-
10	NC

## 2.2.9 F\_USB2\_1, F\_USB2\_2 (USB 2.0 header)

7

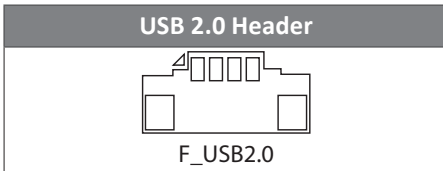
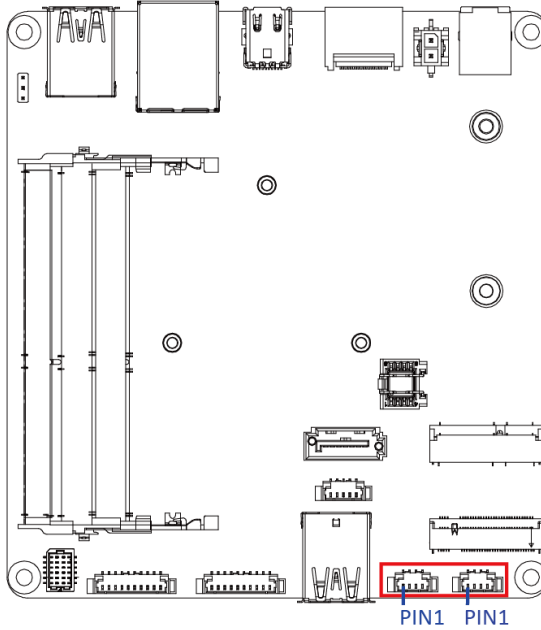

Connector PN	Vendor
A1250WV-S-04PNLBT1T00L	JOINT-TECH
50273-0047N-001	ACES

Pin No.	Definition
1	FUSEVCC3
2	USBN5_C
3	USBP5_C
4	GND

## 2.2.10 SATA\_PWR\_0 (SATA 6Gb/s power connector)

10

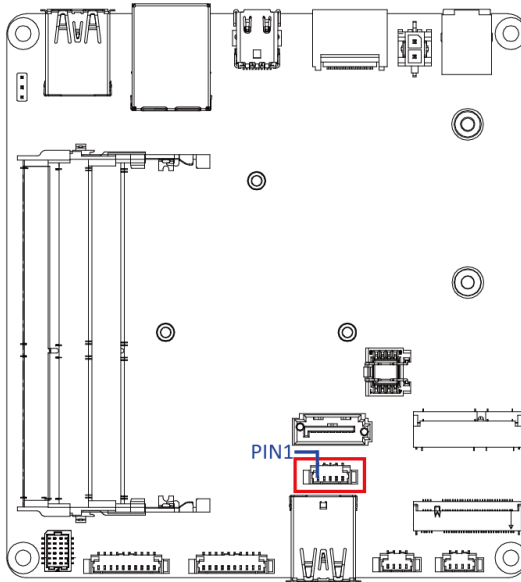

SATA 6Gb/s power connector

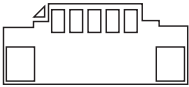

SATA\_PWR\_0

Connector PN

85205-0570N

CI4405M1VRP-LF

Vendor

ACES

CVILUX

Pin No.	Definition
1	+V5S
2	+V5S
3	+V3.3S
4	GND
5	GND

## 2.2.11 SATA0 (SATA 6Gb/s connector)

11

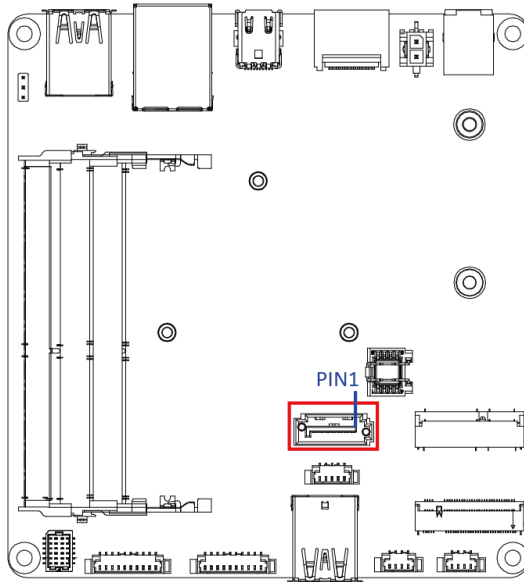

SATA 6Gb/s power connector

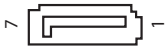

Connector PN

WATF-07DBLBA1UW

Vendor

WINWIN

Pin No. Definition

Pin No.	Definition
1	GND
2	TXP
3	TXN
4	GND
5	RXN
6	RXP
7	GND