

iTXL-Q47EA (MQ47EAT-SI)

Thin Mini-ITX Motherboard

User's Manual 1st Ed

Copyright Notice

This document is copyrighted, 2021. All rights are reserved. The original manufacturer reserves the right to make improvements to the products described in this manual at any time without notice.

No part of this manual may be reproduced, copied, translated, or transmitted in any form or by any means without the prior written permission of the original manufacturer. Information provided in this manual is intended to be accurate and reliable. However, the original manufacturer assumes no responsibility for its use, or for any infringements upon the rights of third parties that may result from its use.

The material in this document is for product information only and is subject to change without notice. While reasonable efforts have been made in the preparation of this document to assure its accuracy, GIGAIPC assumes no liabilities resulting from errors or omissions in this document, or from the use of the information contained herein.

GIGAIPC reserves the right to make changes in the product design without notice to its users.

Acknowledgement

All other products' name or trademarks are properties of their respective owners.

- Microsoft Windows is a registered trademark of Microsoft Corp.
- Intel, Pentium, Celeron, and Xeon are registered trademarks of Intel Corporation
- Core, Atom are trademarks of Intel Corporation
- ITE is a trademark of Integrated Technology Express, Inc.
- IBM, PC/AT, PS/2, and VGA are trademarks of International Business Machines Corporation.

All other product names or trademarks are properties of their respective owners.

Packing List

Before setting up your product, please make sure the following items have been shipped:

Item	Quantity
iTXL-Q47EA MB	1
SATA power cable	2
Standard I/O Shield	1
Low-Profile I/O Shield	1

If any of these items are missing or damaged, please contact your distributor or sales representative immediately.

About this Document

This User's Manual contains all the essential information, such as detailed descriptions and explanations on the product's hardware and software features (if any), its specifications, dimensions, jumper/connector settings/definitions, and driver installation instructions (if any), to facilitate users in setting up their product.

Users may refer to the GIGAIPC.com for the latest version of this document.

Safety Precautions

Please read the following safety instructions carefully. It is advised that you keep this manual for future references

1. All cautions and warnings on the device should be noted.
2. Make sure the power source matches the power rating of the device.
3. Position the power cord so that people cannot step on it. Do not place anything over the power cord.
4. Always completely disconnect the power before working on the system's hardware.
5. No connections should be made when the system is powered as a sudden rush of power may damage sensitive electronic components.
6. If the device is not to be used for a long time, disconnect it from the power supply to avoid damage by transient over-voltage.
7. Always disconnect this device from any AC supply before cleaning.
8. While cleaning, use a damp cloth instead of liquid or spray detergents.
9. Make sure the device is installed near a power outlet and is easily accessible.
10. Keep this device away from humidity.
11. Place the device on a solid surface during installation to prevent falls
12. Do not cover the openings on the device to ensure optimal heat dissipation.

13. Watch out for high temperatures when the system is running.
14. Do not touch the heat sink or heat spreader when the system is running
15. Never pour any liquid into the openings. This could cause fire or electric shock.
16. As most electronic components are sensitive to static electrical charge, be sure to ground yourself to prevent static charge when installing the internal components. Use a grounding wrist strap and contain all electronic components in any static-shielded containers.
17. If any of the following situations arises, please the contact our service personnel:
 - i. Damaged power cord or plug
 - ii. Liquid intrusion to the device
 - iii. Exposure to moisture
 - iv. Device is not working as expected or in a manner as described in this manual
 - v. The device is dropped or damaged
 - vi. Any obvious signs of damage displayed on the device
- 18. DO NOT LEAVE THIS DEVICE IN AN UNCONTROLLED ENVIRONMENT WITH TEMPERATURES BEYOND THE DEVICE'S PERMITTED STORAGE TEMPERATURES (SEE CHAPTER 1) TO PREVENT DAMAGE.**

FCC Statement

Warning!



This device complies with Part 15 FCC Rules. Operation is subject to the following two conditions: (1) this device may not cause harmful interference, and (2) this device must accept any interference received including interference that may cause undesired operation.

Caution:

There is a danger of explosion if the battery is incorrectly replaced. Replace only with the same or equivalent type recommended by the manufacturer. Dispose of used batteries according to the manufacturer's instructions and your local government's recycling or disposal directives.

Attention:

Il y a un risque d'explosion si la batterie est remplacée de façon incorrecte. Ne la remplacer qu'avec le même modèle ou équivalent recommandé par le constructeur. Recycler les batteries usées en accord avec les instructions du fabricant et les directives gouvernementales de recyclage.

China RoHS Requirements (CN)

产品中有毒有害物质或元素名称及含量

GIGAIPC Main Board/ Daughter Board/ Backplane

部件名称	有毒有害物质或元素					
	铅 (Pb)	汞 (Hg)	镉 (Cd)	六价铬 (Cr(VI))	多溴联苯 (PBB)	多溴二苯醚 (PBDE)
印刷电路板 及其电 子组件	○	○	○	○	○	○
外部信号 连接器 及线材	○	○	○	○	○	○

○: 表示该有毒有害物质在该部件所有均质材料中的含量均在 SJ/T 11363-2006 标准规定的限量要求以下。
 X: 表示该有毒有害物质至少在该部件的某一均质材料中的含量超出 SJ/T 11363-2006 标准规定的限量要求。
 备注: 此产品所标示之环保使用期限, 系指在一般正常使用状况下。

China RoHS Requirement (EN)

Poisonous or Hazardous Substances or Elements in Products GIGAIPC Main Board/ Daughter Board/ Backplane

Component	Poisonous or Hazardous Substances or Elements					
	Lead (Pb)	Mercury (Hg)	Cadmium (Cd)	Hexavalent Chromium (Cr(VI))	Polybrominated Biphenyls (PBB)	Polybrominated Diphenyl Ethers (PBDE)
PCB & Other Components	○	○	○	○	○	○
Wires & Connectors for External Connections	○	○	○	○	○	○
<p>○ : The quantity of poisonous or hazardous substances or elements found in each of the component's parts is below the SJ/T 11363-2006-stipulated requirement.</p> <p>X: The quantity of poisonous or hazardous substances or elements found in at least one of the component's parts is beyond the SJ/T 11363-2006-stipulated requirement.</p> <p>Note: The Environment Friendly Use Period as labeled on this product is applicable under normal usage only</p>						

Table Contents

Thin Mini-ITX Motherboard User's Manual 1st Ed	1
Copyright Notice	2
Acknowledgement	3
Packing List.....	4
About this Document	5
Safety Precautions	6
FCC Statement.....	8
China RoHS Requirements (CN).....	9
China RoHS Requirement (EN)	10
Chapter 1 - Product Specifications	13
1.1 Specifications	15
Chapter 2 – Hardware Information	17
2.1 Jumpers and Connectors	18
2.2.1 IO Connector Information.....	22
2.2.2 DC_IN (DC In Jack).....	23
2.2.3 DC_IN2 (ATX 1x4 Pin Power Connector).....	24
2.2.4 SATA2, 3, 4, 5 (SATA 6Gb/s Connector)	25
2.2.5 Battery (Battery Connector)	26
2.2.6 FP_Audio (Front Panel Audio Header)	27
2.2.7 SPKR (Speaker Out Connector)	28
2.2.8 M2E (M.2 Slot, 2230 E-Key)	29
2.2.9 PCIEX8 (1 x PCIe x16 (Gen3 x8 bus) slot).....	29

2.2.10	CPU_FAN (CPU FAN Connector)	30
2.2.11	FUSB2_2 (USB 2.0 Header)	31
2.2.12	FUSB2_1 (USB 2.0 Header).....	32
2.2.13	SYS_FAN (System Fan Connector)	33
2.2.14	LSW (LVDS Resolution Jumper).....	34
2.2.15	EDP (Embedded Display Port connector)	35
2.2.16	BKL_CN (Backlight Control Connector)	36
2.2.17	LVDS (LVDS Connector)	37
2.2.18	SYS_PANEL (System Panel Header).....	38
2.2.19	GPIO_CNT (General purpose input/output Connector)...	39
2.2.20	COM1 (COM header RS-232/422/485 & RI/5V/12V)	40
2.2.21	JCOM1 (COM1 RI# pin RI#/5V/12V Select).....	41
2.2.22	AT_CN (AT/ATX mode select jumper).....	42
2.2.23	COM2 (RS232 Serial Port Header)	43
2.2.24	F_USB2_3 (USB 2.0 Header).....	44
2.2.25	ATX_CTL (ATX Control Header, Support PS-ON Signal of Power Supply Unit)	45
2.2.26	SATA_PWR1, SATA_PWR2 (SATA Power Connector x2) .	46
2.2.27	CLR_CMOS (Clear CMOS Jumper).....	47
2.2.28	SODIMM1, SODIMM2 (2 x DDR4 SO-DIMM Sockets) ...	48
2.2.29	M2M (M.2 Slot, 2280 M-Key)	48

Chapter 1

Chapter 1 - Product Specifications

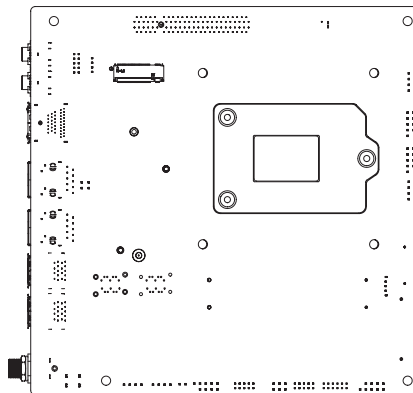
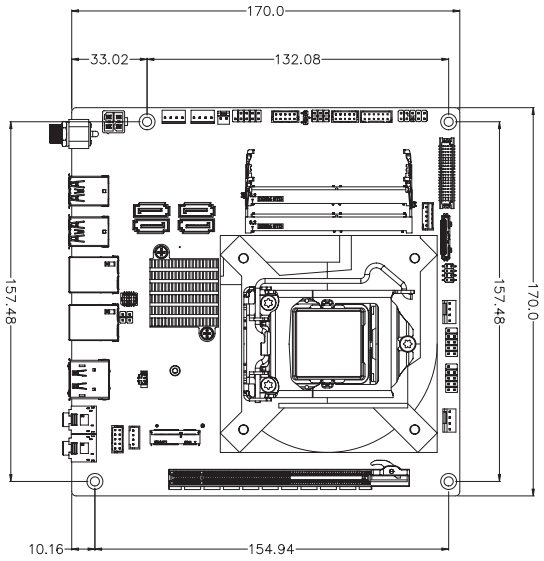
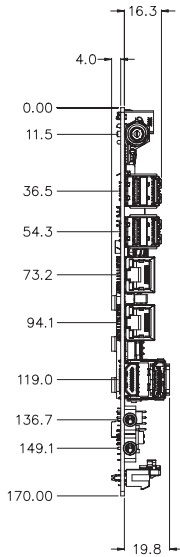

1.1 Specifications

Motherboard	iTXL-Q47EA (MQ47EAT-SI)
Form Factor	Thin Mini-ITX 170W x 170D (mm)
CPU	Support for 10th Generation Intel® Core™ i9/i7/i5/i3 processors, Pentium® & Celeron® processors in the LGA1200 package TDP under 65W L3 cache varies with CPU
Socket	LGA 1200
Chipset	Intel® Q470E Express Chipset
Memory	2 x DDR4 SO-DIMM sockets, Max. Capacity 64GB Support Dual channel DDR4 2933/2666/2400 MHz memory modules
Ethernet	2 x GbE LAN Ports (Intel® I219LM & I211AT)
Video	Integrated Graphics Processor - Intel® HD Graphics support: 1 x HDMI 2.0 port, supporting a maximum resolution of 4096x2160 @60Hz 1 x DP port, supporting a maximum resolution of 4096x2160 @60Hz 1 x LVDS port, supporting a maximum resolution of 1920x1080 @60Hz 1 x eDP port, supporting a maximum resolution of 4096x2160 @60Hz * eDP connector is alternative with LVDS port, only one can be worked at the same time (3 independent display outputs)
Audio	Realtek® ALC897
Storage	4 x SATA 6Gb/s Ports
Raid	Intel® SATA RAID 0/1/5/10
Expansion Slots	1 x PCIe x16 (Gen3 x8) 1 x 2280 M.2 M-Key (PCIe x4, SATA 6Gb/s) 1 x 2230 M.2 E-Key

Motherboard		iTXL-Q47EA (MQ47EAT-SI)
Internal I/O	<ul style="list-style-type: none"> 1 x 4-pin ATX main power connector 2 x SATA Power connectors 1 x CPU fan header 1 x System fan header 1 x Front panel header 1 x Front panel audio header 1 x 2W Speaker out header 6 x USB 2.0 headers 1 x COM header (RS-232) 1 x COM header (RS-232/422/485 & RI/5V/12V) 1 x GPIO (8 bits) & SMBus header 1 x Clear CMOS jumper 1 x Backlight Control header 1 x ATX Control header 1 x AT/ATX mode select jumper 	
Rear I/O	<ul style="list-style-type: none"> 2 x Audio Jacks (Line out, Mic in) 1 x HDMI 1 x Display Port 2 x RJ45 LAN Ports 4 x USB 3.2 Gen 1 1 x DC Jack (+12V/+19~24VDC) 	
TPM	1 x TPM Header	
OS Compatibility	Windows® 10 (x64)	
PSU Connectors	<ul style="list-style-type: none"> 1 x DC-in (+12V/ +19~24VDC) 1 x 4-pin ATX power connector 	
Operating Properties	<ul style="list-style-type: none"> Operating temperature: 0°C to 60°C Operating humidity: 0-90% (non-condensing) Non-operating temperature: -40°C to 85°C Non-operating humidity: 0%-95% (non-condensing) 	
Order Information	Motherboard: 9MQ47EATMR-SI	
Optional kit:	<ul style="list-style-type: none"> TPM 2.0 module : 9CTM000NR-00 TPM Cable : 25CRZ-100600-S9R 	

Chapter 2

Chapter 2 – Hardware Information

2.1 Jumpers and Connectors

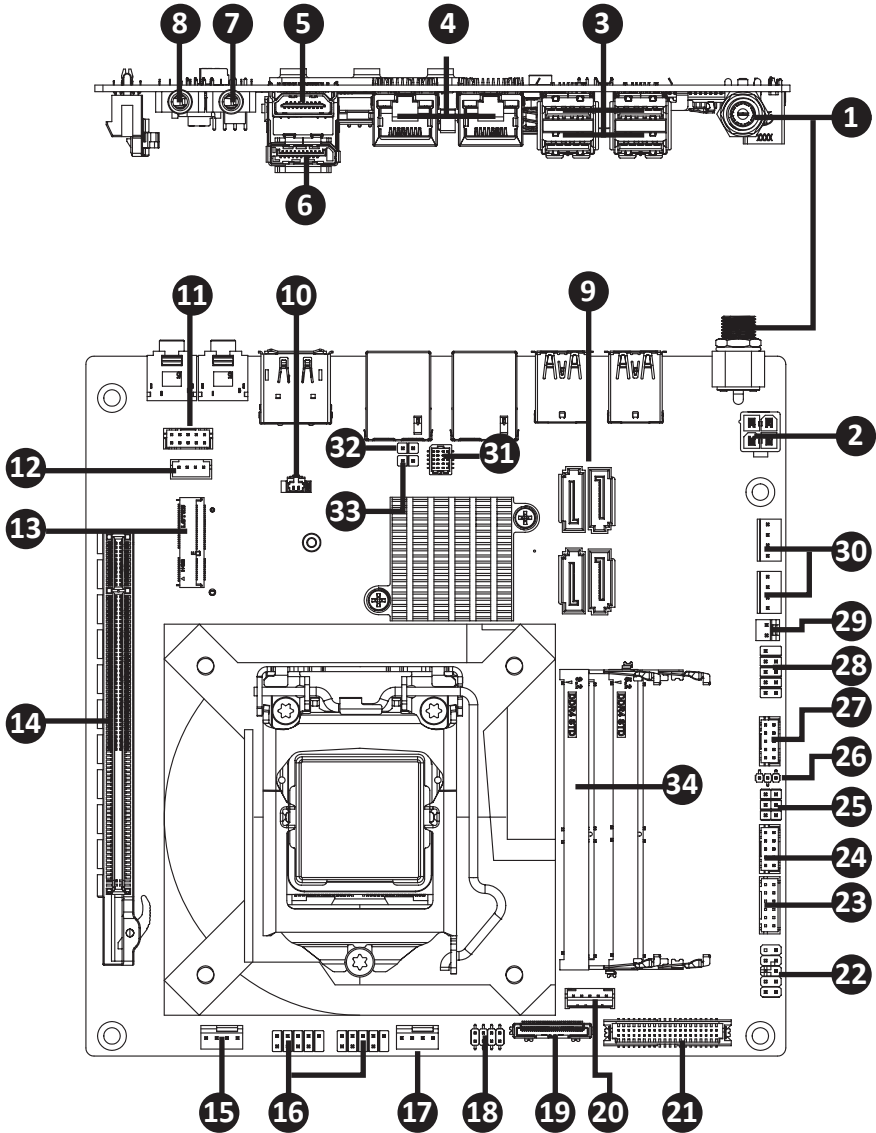

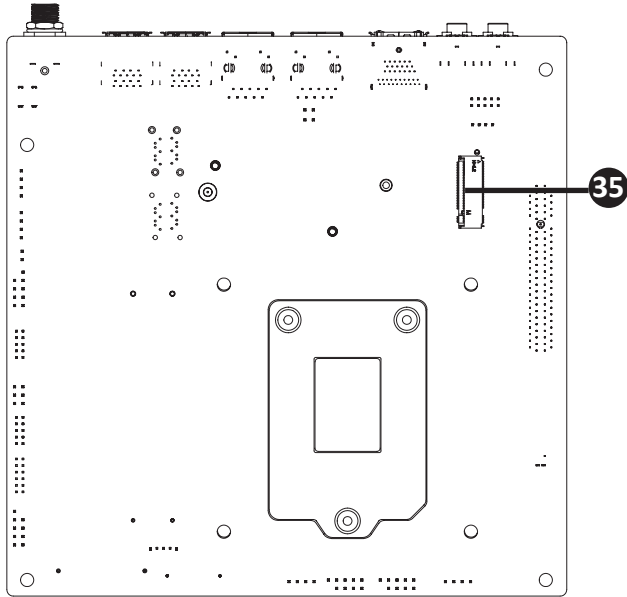

No	Code	Description
1	DC_IN	DC In Jack
2	DC_IN2	ATX 2x2 Pin Power Connector
3	USB31_1, USB31_2,	USB 3.2 Gen 1 Type A Connector x 4
4	LAN1, LAN2	GbE Ethernet LAN ports x 2
5	HDMI 2	HDMI 2.0 Connector
6	DP	Display Port Connector
7	LINE_OUT	Line Out port (Green)
8	MIC_IN	Mic In port (Pink)

No	Code	Description
9	SATA2, 3, 4, 5	SATA 6 Gb/s Connector x 4
10	Battery	Battery Connector
11	FP_Audio	Front Panel Audio Header
12	SPKR	Speaker out Connector
13	M2E	M.2 Slot, 2230 E-Key
14	PCIEX8	1 x PCIe x16 (Gen3 x8 bus) slot
15	CPU_FAN	CPU FAN Connector
16	FUSB2_1	USB 2.0 Header
16	FUSB2_2	USB 2.0 Header
17	SYS_FAN	System Fan Connector
18	LSW	LVDS Resolution Jumper
19	EDP	Embedded Display Port connector
20	BKL_CN	Backlight Control Connector
21	LVDS	LVDS Connector
22	SYS_PANEL	System Panel Header
23	GPIO_CNT	General purpose input/out Connector
24	COM1	COM header RS-232/422/485 & RI/5V/12V
25	JCOM1	COM1 RI# pin RI#/5V/12V Select
26	AT_CN	AT/ATX mode select jumper
27	COM2	COM header RS232
28	FUSB2_3	USB 2.0 Header
29	ATX_CTL	ATX Control Header, Support PS-ON Signal of Power Supply Unit

No	Code	Description
30	SATA_PWR1 SATA_PWR2	SATA power Connector x 2
32	CLR_CMOS	Clear CMOS Jumper
33	SODIMM1, SODIMM2	2 x DDR4 SO-DIMM Sockets
34	M2M	M.2 Slot, 2280 M-Key

2.2.1 IO Connector Information

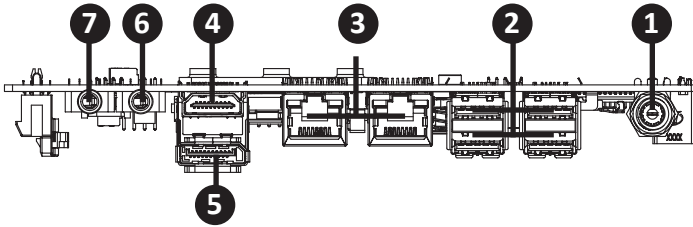

	Code	Description
1	DC_IN	DC In Jack
2	USB31_1, USB31_2,	USB3.2 Gen 1 Type A Connector x 4
3	LAN1, LAN2	GbE Ethernet LAN port x 2
4	HDMI 2	HDMI 2.0 Connector
5	DP	Display Port Connector
6	LINE_OUT	Line Out port (Green)
7	MIC_IN	Mic In port (Pink)

2.2.2 DC_IN (DC In Jack)

1

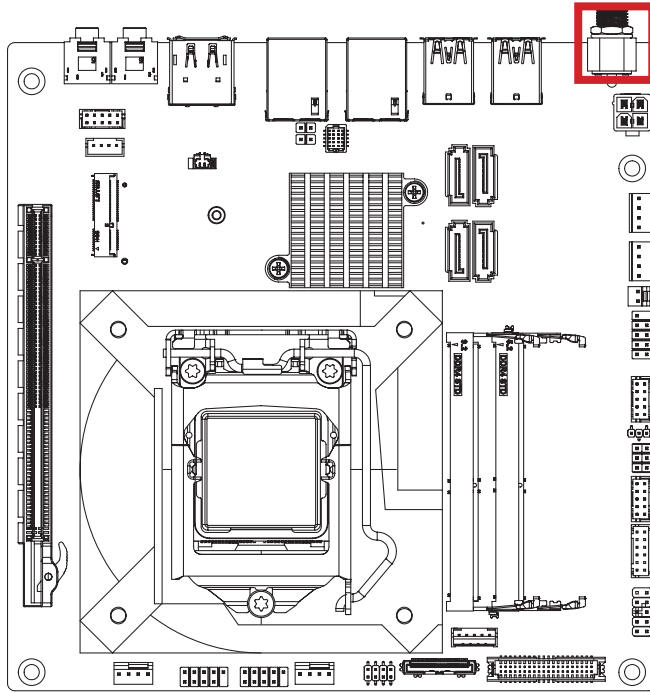

DC In Jack



Connector PN

655-360-000

Vendor

SHEN-MING

2.2.3 DC_IN2 (ATX 1x4 Pin Power Connector)

2

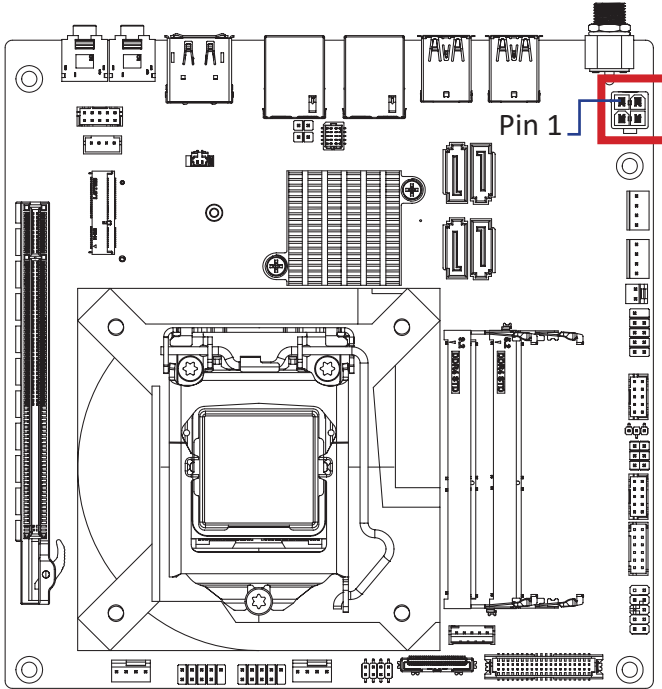

Power Connector



Connector PN	Vendor
740-81-04TW56	PINREX

Connector PN	Vendor
740-81-04TW56	PINREX

Pin No.	Definition
1	GND
2	GND
3	DC IN
4	DC IN

2.2.4 SATA2, 3, 4, 5 (SATA 6Gb/s Connector)

9

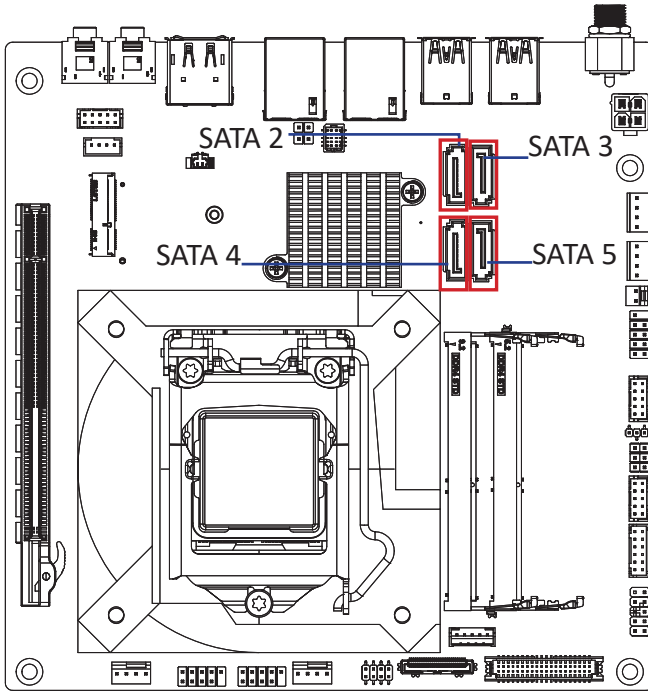

SATA 6GB/S Connector

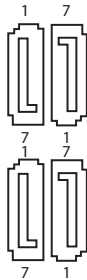

Pin No.	Definition
1	GND
2	TXP
3	TXN
4	GND
5	RXN
6	RXP
7	GND

2.2.5 Battery (Battery Connector)

10

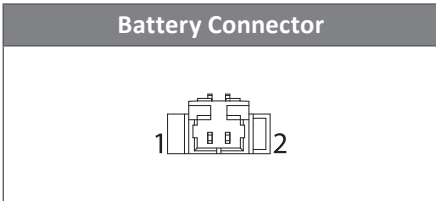
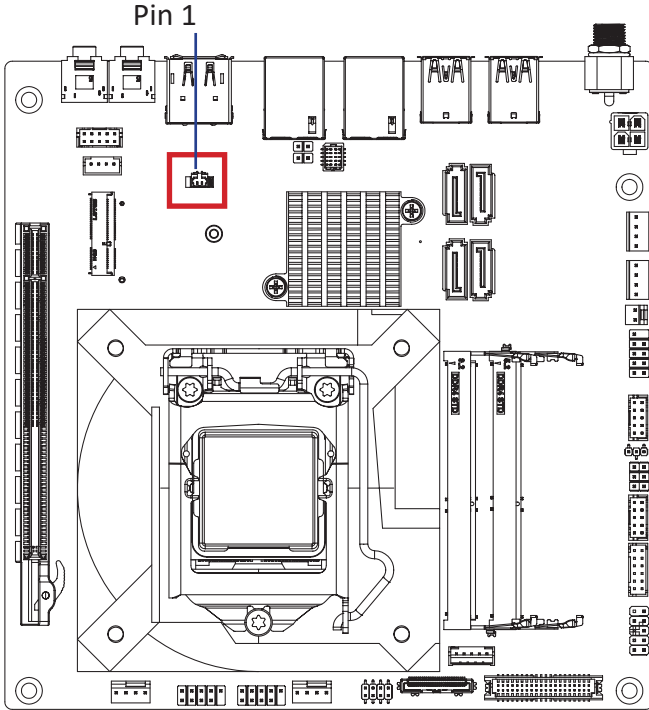

Pin No.	Definition
1	3V
2	GND

2.2.6 FP_Audio (Front Panel Audio Header)

11

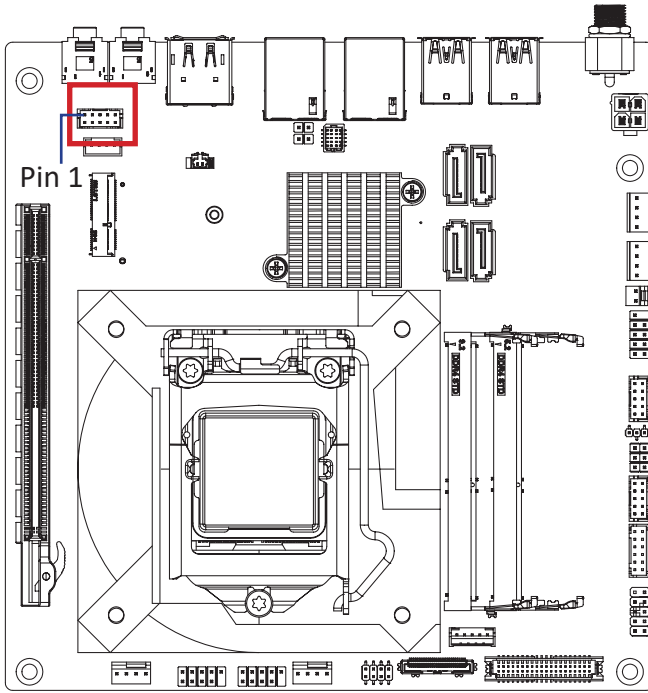

Front Audio Connector

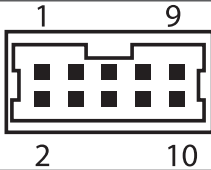

Connector PN

725-81-10TW00
A2004WV-2X05P46

Vendor

PINREX
JOINT-TECH

Pin No.	Definition	Pin No.	Definition
1	MIC-LEFT	6	GND
2	GND	7	JACKSENCE DELTECT
3	MIC-RIGHT	8	NC
4	DELTECT	9	LINE-LEFT
5	LINE-RIGHT	10	GND

2.2.7 SPKR (Speaker Out Connector)

12

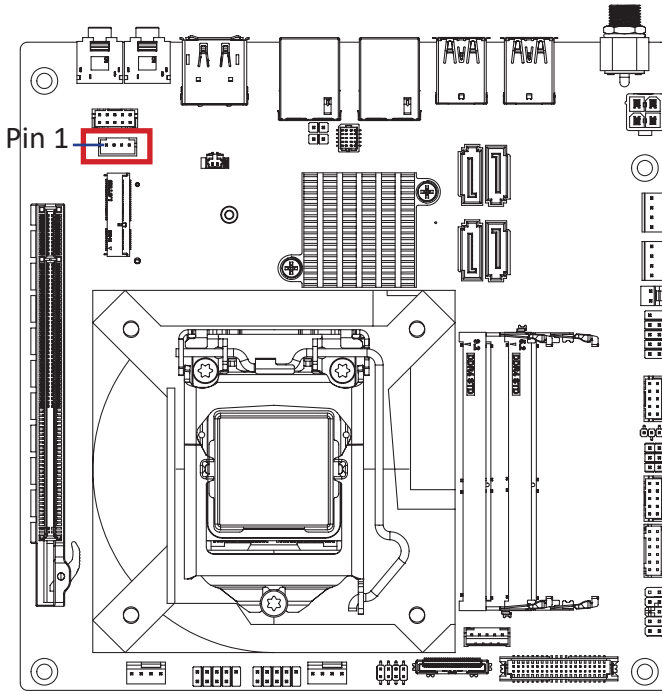

Speaker Out Connector

1



Pin No.	Definition
1	SPEAKER L+
2	SPEAKER L-
3	SPEAKER R-
4	SPEAKER R+

Connector PN

721-81-045W00

A2001WV-04P146

Vendor

PINREX

JOINT-TECH

2.2.8 M2E (M.2 Slot, 2230 E-Key)

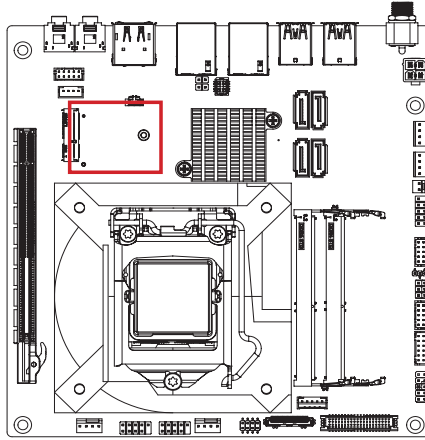
13

2.2.9 PCIe8 (1 x PCIe x16 (Gen3 x8 bus) slot)

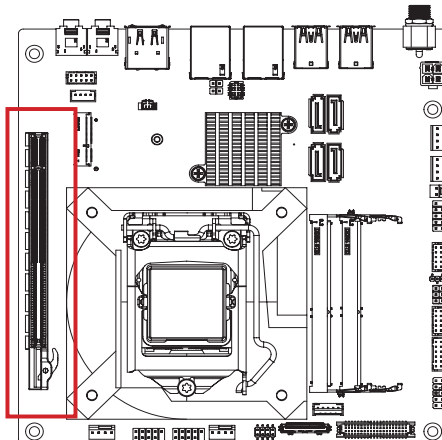
14

2.2.10 CPU_FAN (CPU FAN Connector)

15

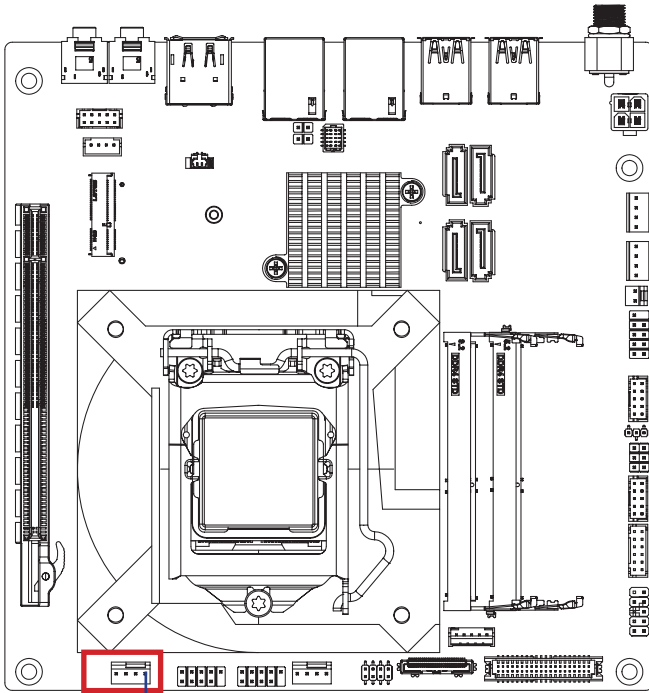

Pin 1

CPU Fan Connector	
4	1

Connector PN	Vendor
744-81-045W11	PINREX

Pin No.	Definition
1	GND
2	12V
3	Sense
4	PWM

2.2.11 FUSB2_2 (USB 2.0 Header)

16

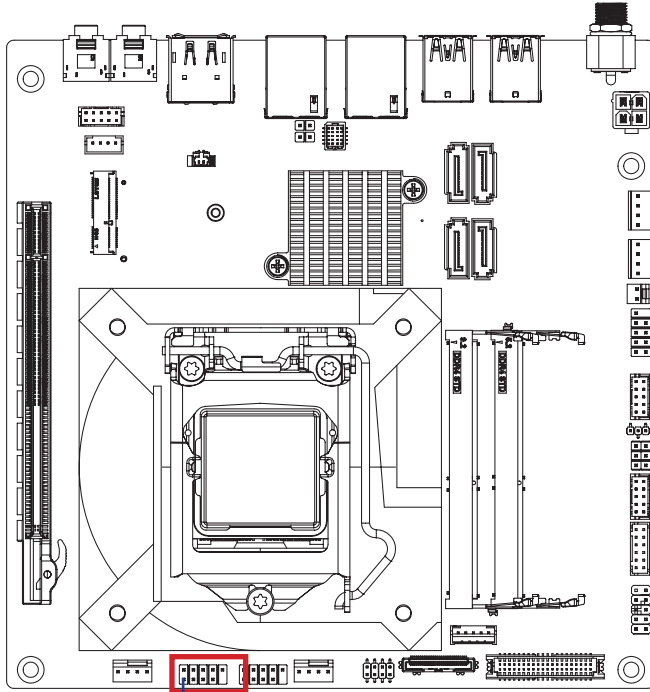

Pin 1

USB 2.0 Header

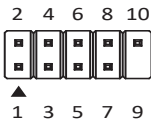

Connector PN

210-92-05GB04

PH10R53BAZ009

Vendor

PINREX

HORNGTONG

Pin No.	Definition
1	5V
2	5V
3	D2n
4	D1n
5	D2p
6	D1p
7	GND
8	GND
9	No Pin
10	NC

2.2.12 FUSB2_1 (USB 2.0 Header)

16

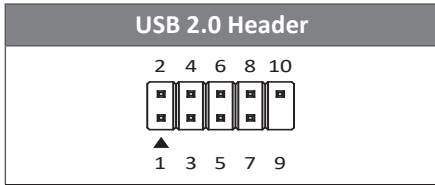
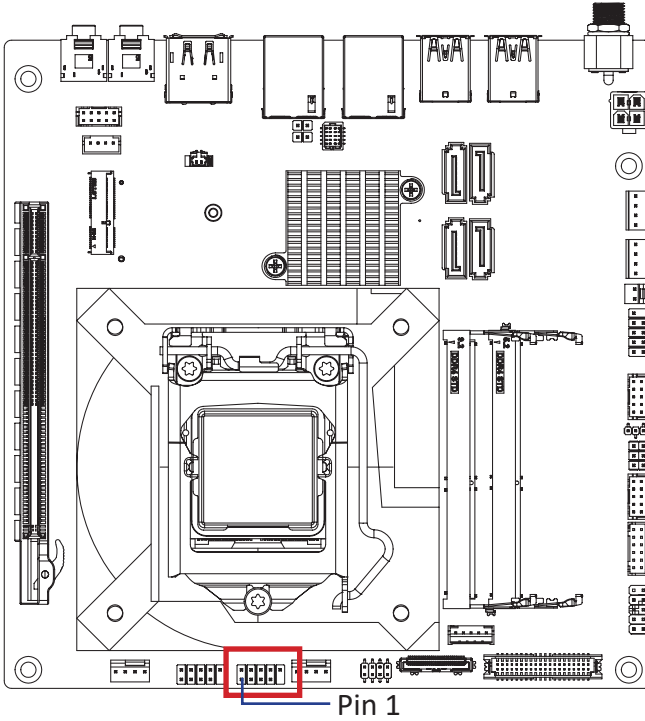

Connector PN	Vendor
210-92-05GB04	PINREX
PH10R53BAZ009	HORNGTONG

Pin No.	Definition
1	5V
2	5V
3	D2n
4	D1n
5	D2p
6	D1p
7	GND
8	GND
9	No Pin
10	NC

2.2.13 SYS_FAN (System Fan Connector)

17

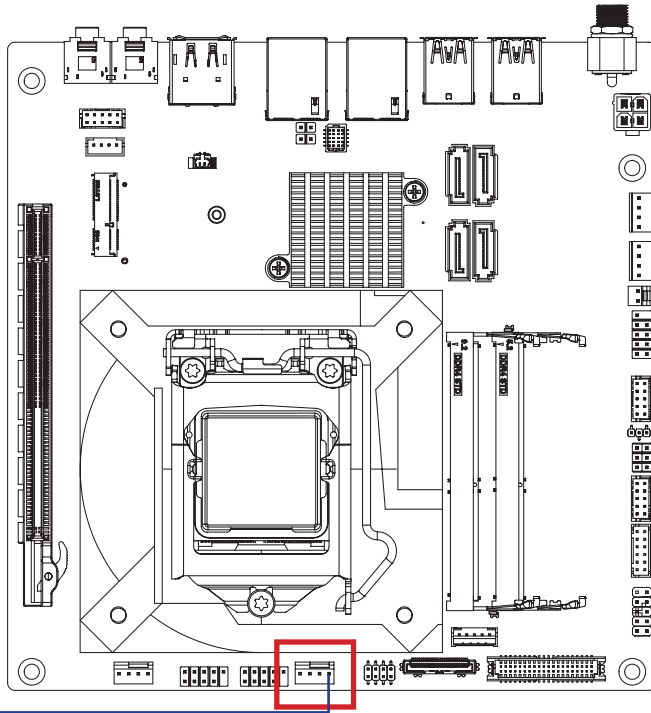

Pin 1

System FAN	
4	1









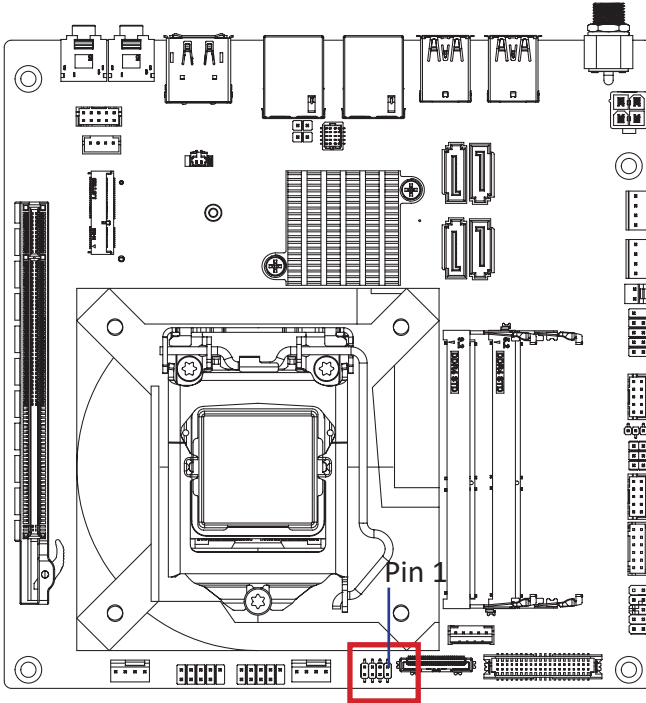





Connector PN	Vendor
744-81-045R11	PINREX
WF04R22RJQ105	HORNGTONG

Pin No.	Definition
1	GND
2	12V
3	Sense
4	PWM

2.2.14 LSW (LVDS Resolution Jumper)

18



LVDS Resolution Jumper			
Jumper Setting	Resolution	Jumper Setting	Resolution
8 1	800 x 600 18bit	1 	1366 x 768 24bit
1 	1024 x 768 18bit	1 	1440 x 900 24bit
1 	1024 x 768 24bit	1 	1400 x 1050 24bit
1 	1024 x 600 18bit	1 	1600 x 900 24bit
1 	1280 x 800 18bit	1 	1680 x 1050 24bit
1 	1280 x 960 18bit	1 	1600 x 1200 24bit
1 	1280 x 1024 24bit	1 	1920 x 1080 24bit
1 	1366 x 768 18bit	1 	1920 x 1200 24bit

Connector PN	Vendor
222-97-04GBE1	PINREX

2.2.15 EDP (Embedded Display Port connector)

19

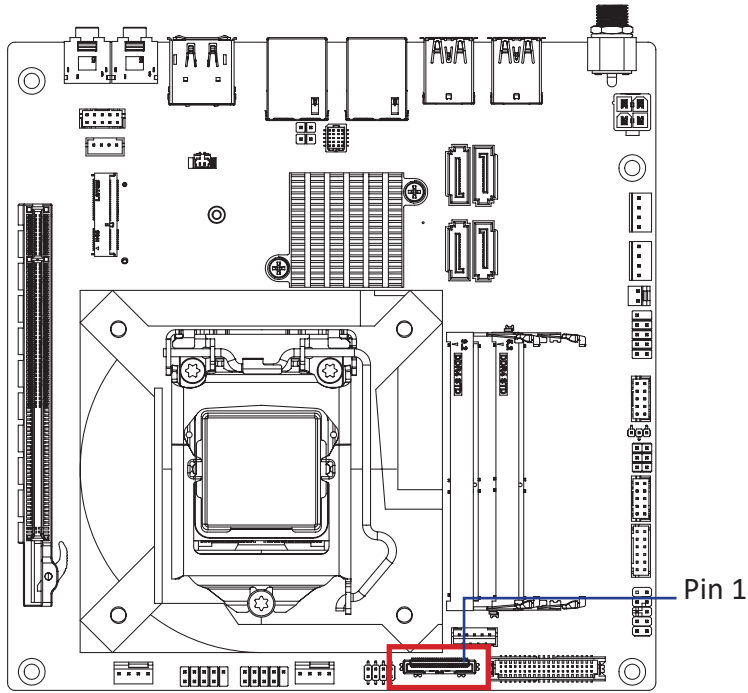

Embedded Display Port connector

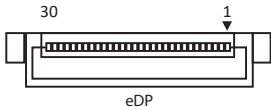

Pin No.	Definition	Pin No.	Definition
1	GND	16	GND
2	TX0n	17	Hot Plug Detect
3	TX0p	18	Backlight Enable
4	GND	19	GND
5	TX1n	20	Backlight control
6	TX1p	21	GND
7	GND	22	3.3V
8	TX2n	23	3.3V
9	TX2p	24	3.3V

Pin No.	Definition	Pin No.	Definition
10	GND	25	3.3V
11	TX3n	26	GND
12	TX3p	27	5V
13	GND	28	5V
14	AUXn	29	5V
15	AUXp	30	5V

Connector PN	Vendor
115B30-000040-G4-R	STARCONN

2.2.16 BKL_CN (Backlight Control Connector)

20

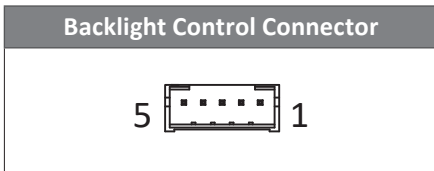
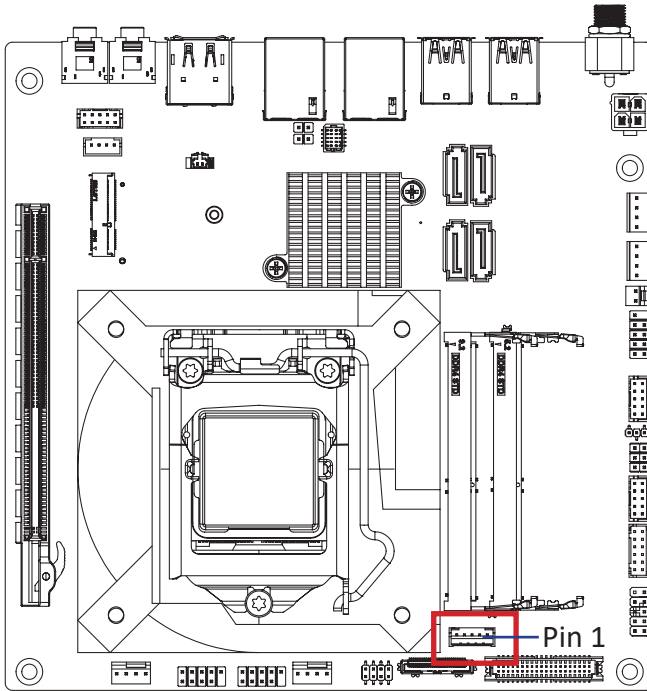

Connector PN	Vendor
721-81-05TW00	PINREX
A2001WV-05P146	JOINT-TECH

Pin No.	Definition
1	5V
2	PWM
3	Backlight enable
4	GND
5	12V

2.2.17 LVDS (LVDS Connector)

21

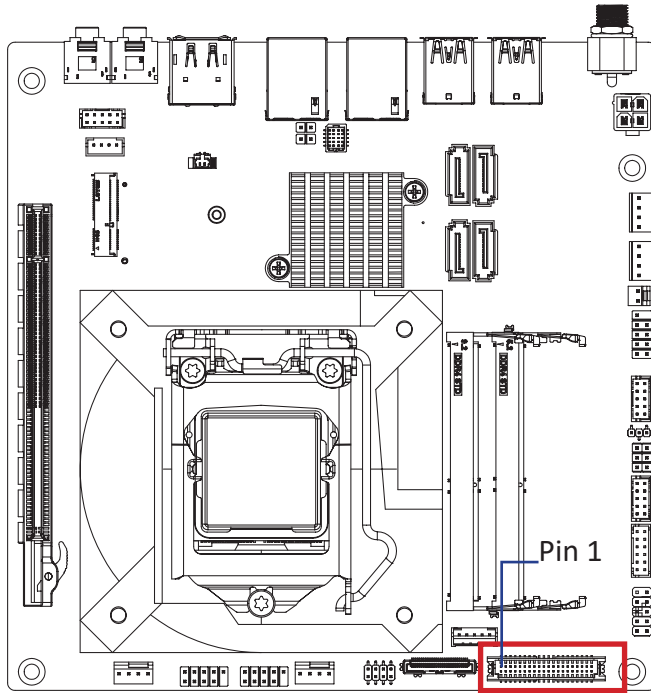

LVDS Connector

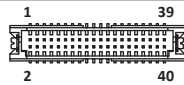

Pin No.	Definition	Pin No.	Definition
1	3.3V	21	A5+
2	5V	22	A4+
3	3.3V	23	A5-
4	5V	24	A4-
5	SPECO	25	GND
6	SPEDO	26	GND
7	GND	27	A7+
8	GND	28	A6+
9	A1+	29	A7-
10	A0+	30	A6-
11	A1-	31	GND
12	A0-	32	GND
13	GND	33	CLK2+
14	GND	34	CLK1+
15	A3+	35	CLK2-
16	A2+	36	CLK1-

Pin No.	Definition	Pin No.	Definition
17	A3-	37	GND
18	A2-	38	GND
19	GND	39	12V
20	GND	40	12V

Connector PN	Vendor
712-76-40GWE0	PINREX
A1252WV-SF-2X20PD01	JOINT-TECH

For each model support LVDS function. But below model no need to add. A0~A3 is odd channel 0~3, A4~A7 is even channel.

Note: *The LVDS output connector of the unit is only intended to be connected to an UL/IEC/EN approval equipment with fire enclosure.

2.2.18 SYS_PANEL (System Panel Header)

22

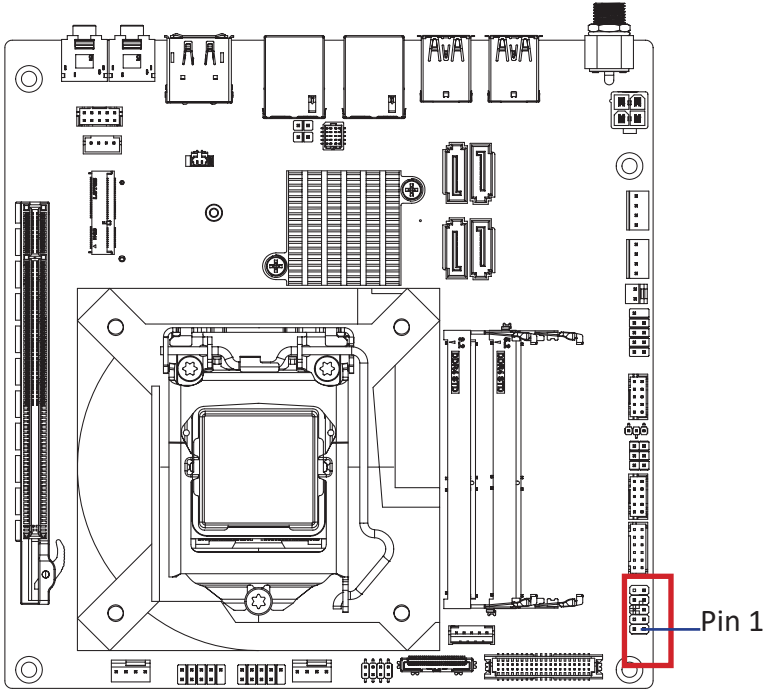

System Panel Header	

Pin No.	Definition
1	HD-P
2	MPD-P
3	HD-N
4	MPD-N
5	GND
6	POWER-ON
7	Reset
8	GND
9	Reserved
10	NC

Connector PN	Vendor
210-92-05G111	PINREX
210-92-05GW5W	PINREX

2.2.19 GPIO_CNT (General purpose input/output Connector)

23

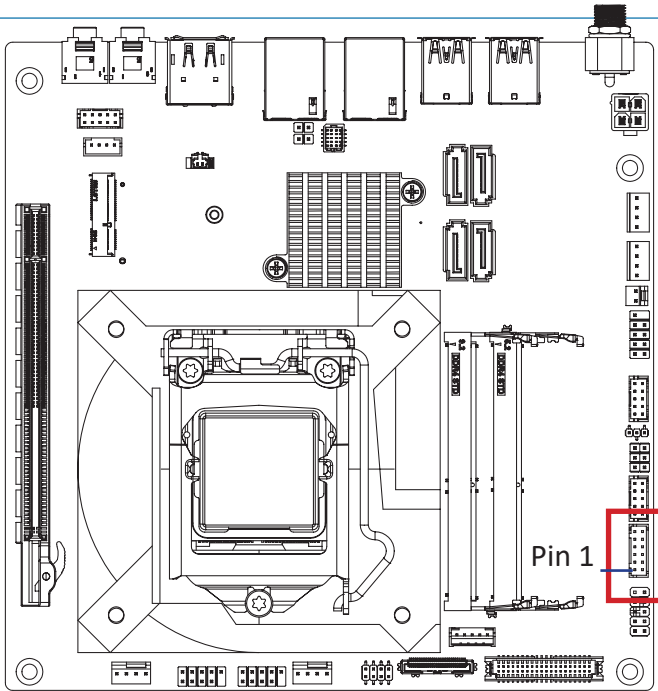

Pin No.	Definition
1	GPIO-output_1
2	GPIO-input_1
3	GPIO-output_2
4	GPIO-input_2
5	GPIO-output_3
6	GPIO-input_3
7	GPIO-output_4

Pin No.	Definition
8	GPIO-input_4
9	SMBus Clock
10	SMBus DATA
11	5V
12	GND

Connector PN	Vendor
725-81-12TW00	PINREX
A2004WV-2X06P46	JOINT-TECH

2.2.20 COM1 (COM header RS-232/422/485 & RI/5V/12V)

24

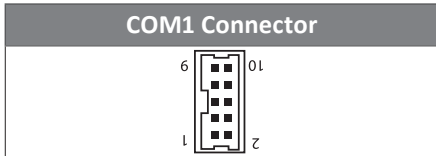
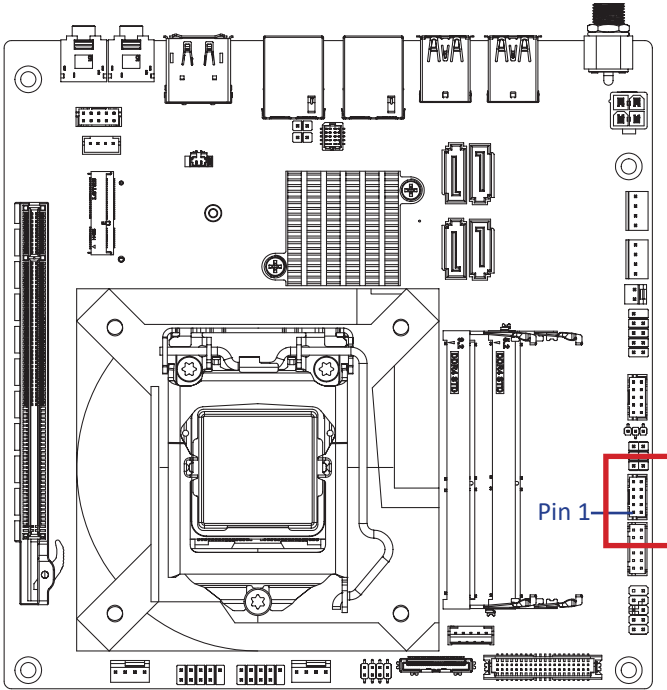

Connector PN	Vendor
725-81-10TW00	PINREX
A2004WV-2X05P46	JOINT-TECH

Pin No.	Definition
1	RX
2	DCD
3	DTR
4	TX
5	DSR
6	GND
7	CTS
8	RTS
9	RI
10	NC

2.2.21 JCOM1 (COM1 RI# pin RI#/5V/12V Select)

25

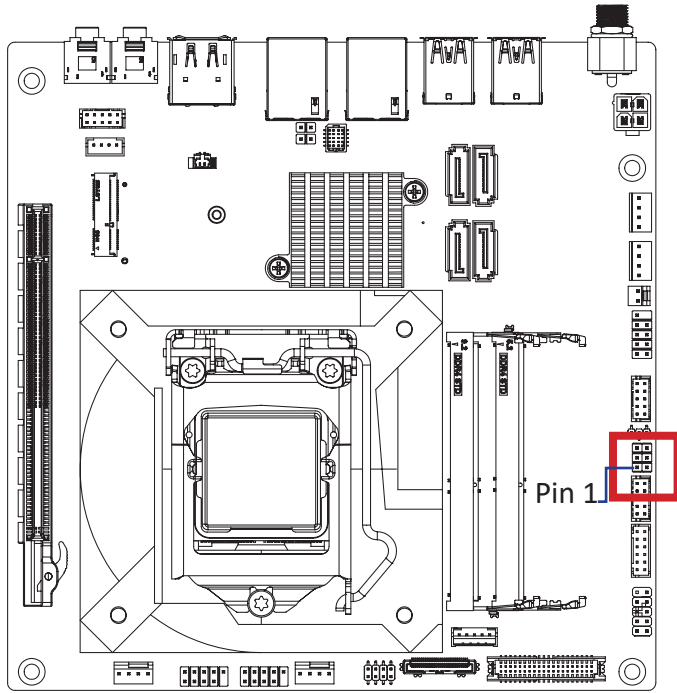

JCOM1 Jumper Select	
	1-2 Close: 5V (Power COM)
	3-4 Close: RI (Stand COM)
	5-6 Close: 12V (Power COM)

Connector PN	Vendor
220-97-03GB01	PINREX
PH06N53BAZ000	HORNGTONG

2.2.22 AT_CN (AT/ATX mode select jumper)

26

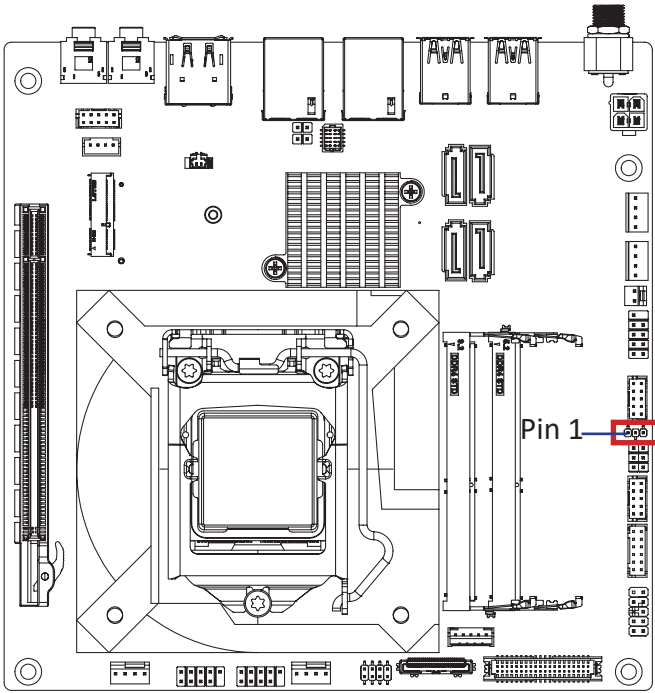

AT/ATX mode select jumper



1

Connector PN

PH03N33BAAA00

Vendor

HORNGTONG

Pin No.	Definition
1	AT MODE
2	Detect
3	ATX MODE

Jumper setting
 1-2 Close : AT mode.
 2-3 Close : ATX mode.(Default setting)

2.2.23 COM2 (RS232 Serial Port Header)

27

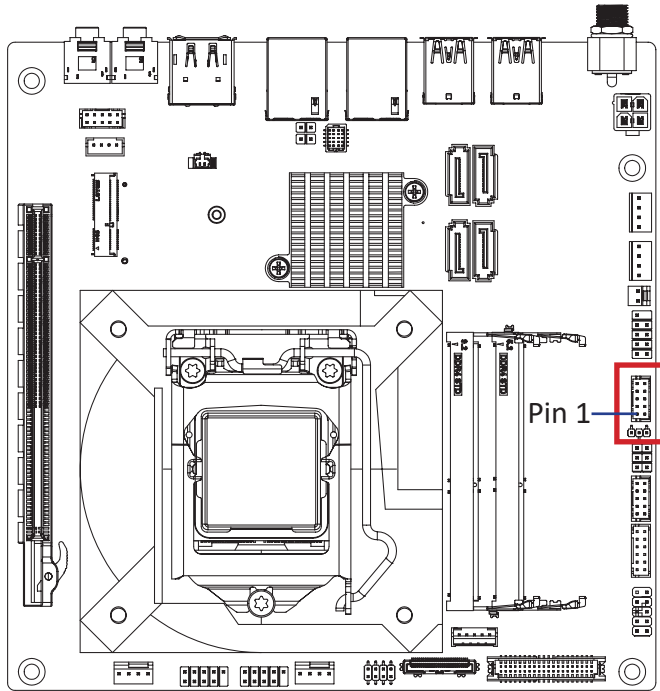

COM 2 Header

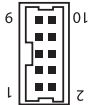

Connector PN

725-81-10TW00

A2004WV-2X05P46

Vendor

PINREX

JOINT-TECH

Pin No.	Definition
1	RX
2	DCD
3	DTR
4	TX
5	DSR
6	GND
7	CTS
8	RTS
9	RI
10	NC

2.2.24 F_USB2_3 (USB 2.0 Header)

28

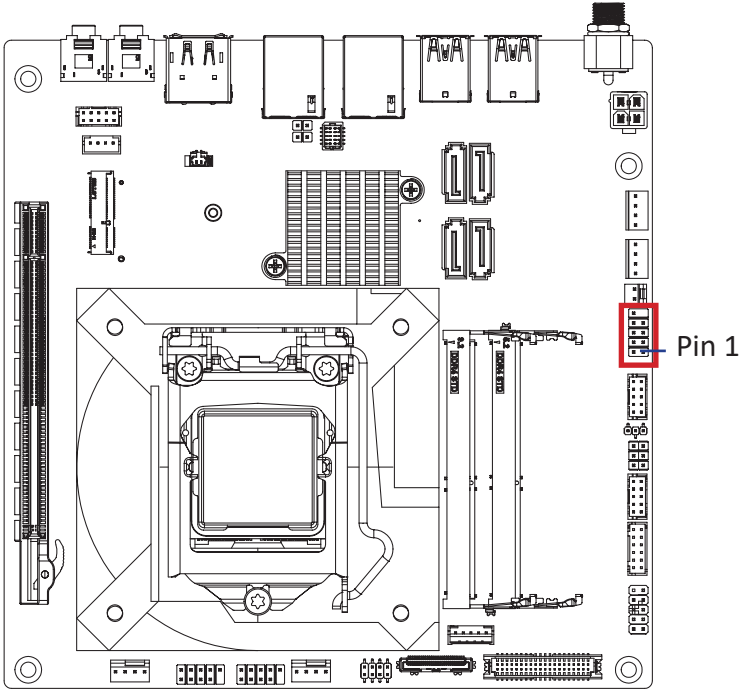

USB 2.0 Header

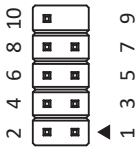

Pin No.	Definition
1	5V
2	5V
3	D2n
4	D1n
5	D2p
6	D1p
7	GND
8	GND
9	No Pin
10	NC

Connector PN

Vendor

210-92-05GB04

PINREX

PH10R53BAZ009

HORNGTONG

2.2.25 ATX_CTL (ATX Control Header, Support PS-ON Signal of Power Supply Unit)

29

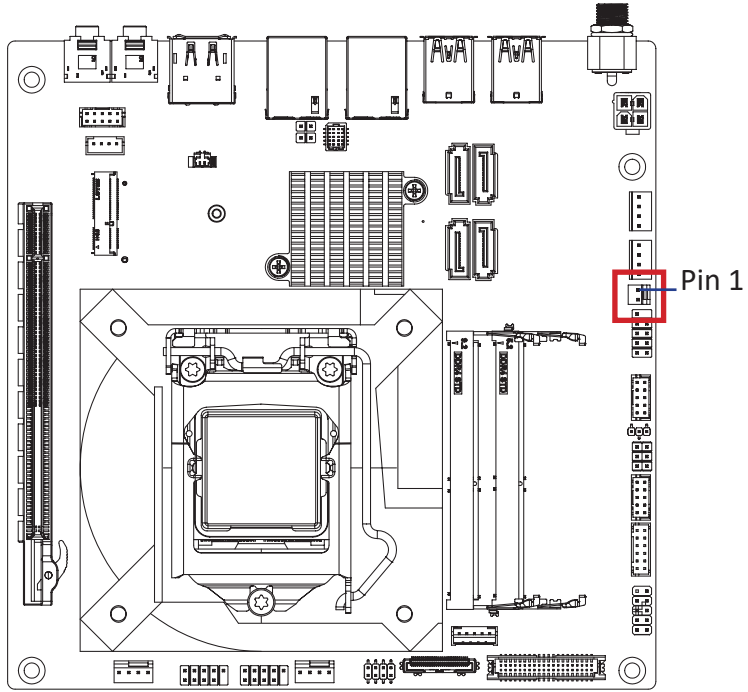

ATX Control Header

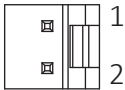

Connector PN

744-81-02TW10

Vendor

PINREX

Pin No.	Definition
1	PSON#
2	5V

2.2.26 SATA_PWR1, SATA_PWR2 (SATA Power Connector x 2)

30

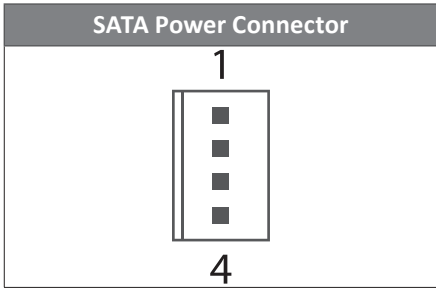
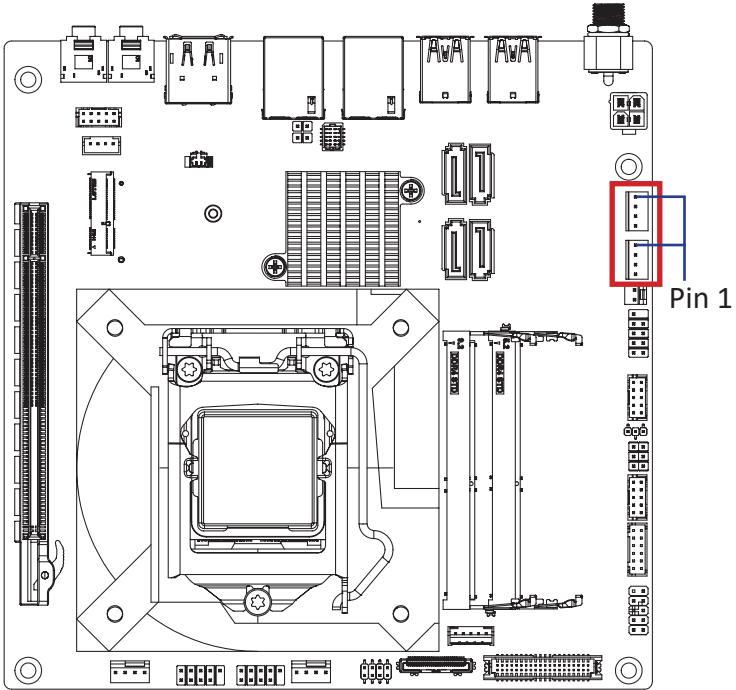

Connector PN	Vendor
743-81-04TW00	PINREX
WF04Q2-3BJQ000	HORNGTONG

Pin No.	Definition
1	5V
2	GND
3	GND
4	5V

2.2.27 CLR_CMOS (Clear CMOS Jumper)

32

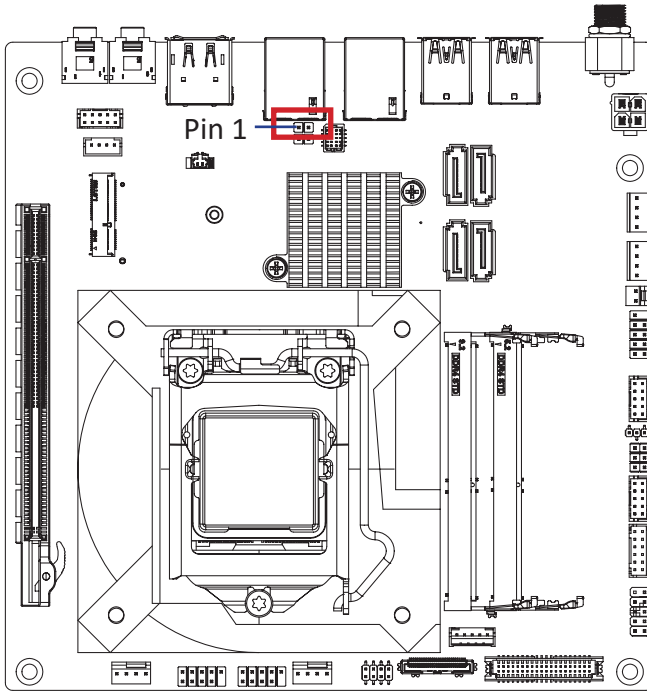

Clear CMOS Jumper



Pin No.	Definition
1	Clear CMOS
2	GND
Open: Normal Operation (Default setting) Close: Clear CMOS data.	

2.2.28 SODIMM1, SODIMM2 (2 x DDR4 SO-DIMM Sockets)

34

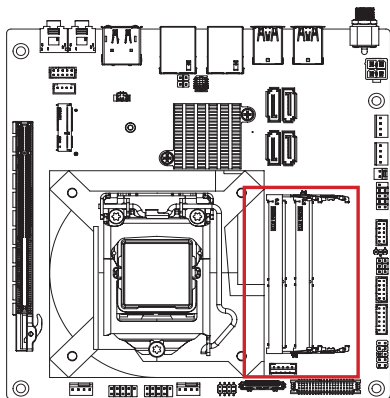

2.2.29 M2M (M.2 Slot, 2280 M-Key)

35

