

# QBiX-Lite-AMDA1605H-A1 (QL-1605A-SI)

---

QBiX-Lite Industrial Embedded System  
Quick Start Guide

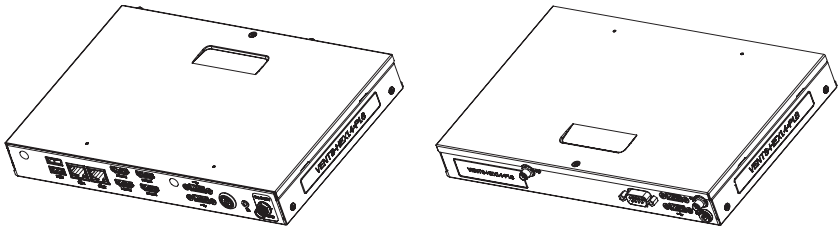

## Copyright Notice

---

This document is copyrighted, 2019. All rights are reserved. The original manufacturer reserves the right to make improvements to the products described in this manual at any time without notice.

No part of this manual may be reproduced, copied, translated, or transmitted in any form or by any means without the prior written permission of the original manufacturer. Information provided in this manual is intended to be accurate and reliable. However, the original manufacturer assumes no responsibility for its use, or for any infringements upon the rights of third parties that may result from its use.

The material in this document is for product information only and is subject to change without notice. While reasonable efforts have been made in the preparation of this document to assure its accuracy, GIGAIPC assumes no liabilities resulting from errors or omissions in this document, or from the use of the information contained herein.

GIGAIPC reserves the right to make changes in the product design without notice to its users.

## Acknowledgement

---

All other products' name or trademarks are properties of their respective owners.

- AMD is trademark of Advanced Micro Devices.
- Microsoft Windows is a registered trademark of Microsoft Corp.
- Intel, Pentium, Celeron, and Xeon are registered trademarks of Intel Corporation
- Core, Atom are trademarks of Intel Corporation
- ITE is a trademark of Integrated Technology Express, Inc.
- IBM, PC/AT, PS/2, and VGA are trademarks of International Business Machines Corporation.

All other product names or trademarks are properties of their respective owners.

# Packing List

---

Before setting up your product, please make sure the following items have been shipped:

Item	Quantity
Power Cord (Optional, by region)	1
PSU ADP 19V 65W 100-240VAC (25EP0-1065W1-A3S)	1
Bracket Wall Mount (25HB1-SD4000-R0R)	1
HDD Screw #2-M3x4L (25KS2-13004G-S0R)	4
M.2 Standoff (12KSF-F10303-20R)	1
Wall Mount Screw M3.0*L6.0 (25KS9-130600-S0R)	4
M.2 Standoff Screw M2x4L (25KSG-130048-S0R)	1
SATA Cable (25CF4-160000-S9R)	1
M.2 Heatsink (25ST1-1231Z1-S7R)	1
WiFi PAD (25ST3-200060-T5R)	1
Exsiccator (10g)	1

If any of these items are missing or damaged, please contact your distributor or sales representative immediately.

## About this Document

---

This User's Manual contains all the essential information, such as detailed descriptions and explanations on the product's hardware and software features (if any), its specifications, dimensions, jumper/connector settings/definitions, and driver installation instructions (if any), to facilitate users in setting up their product.

Users may refer to the [GIGAIPC.com](http://GIGAIPC.com) for the latest version of this document.

## Safety Precautions

---

Please read the following safety instructions carefully. It is advised that you keep this manual for future references

1. All cautions and warnings on the device should be noted.
2. Make sure the power source matches the power rating of the device.
3. Position the power cord so that people cannot step on it. Do not place anything over the power cord.
4. Always completely disconnect the power before working on the system's hardware.
5. No connections should be made when the system is powered as a sudden rush of power may damage sensitive electronic components.
6. If the device is not to be used for a long time, disconnect it from the power supply to avoid damage by transient over-voltage.
7. Always disconnect this device from any AC supply before cleaning.
8. While cleaning, use a damp cloth instead of liquid or spray detergents.
9. Make sure the device is installed near a power outlet and is easily accessible.
10. Keep this device away from humidity.
11. Place the device on a solid surface during installation to prevent falls
12. Do not cover the openings on the device to ensure optimal heat dissipation.

13. Watch out for high temperatures when the system is running.
14. Do not touch the heat sink or heat spreader when the system is running
15. Never pour any liquid into the openings. This could cause fire or electric shock.
16. As most electronic components are sensitive to static electrical charge, be sure to ground yourself to prevent static charge when installing the internal components. Use a grounding wrist strap and contain all electronic components in any static-shielded containers.
17. If any of the following situations arises, please the contact our service personnel:
  - i. Damaged power cord or plug
  - ii. Liquid intrusion to the device
  - iii. Exposure to moisture
  - iv. Device is not working as expected or in a manner as described in this manual
  - v. The device is dropped or damaged
  - vi. Any obvious signs of damage displayed on the device
- 18. DO NOT LEAVE THIS DEVICE IN AN UNCONTROLLED ENVIRONMENT WITH TEMPERATURES BEYOND THE DEVICE'S PERMITTED STORAGE TEMPERATURES (SEE CHAPTER 1) TO PREVENT DAMAGE.**

## FCC Statement

---

### **Warning!**



This device complies with Part 15 FCC Rules. Operation is subject to the following two conditions: (1) this device may not cause harmful interference, and (2) this device must accept any interference received including interference that may cause undesired operation.

### **Caution:**

*There is a danger of explosion if the battery is incorrectly replaced. Replace only with the same or equivalent type recommended by the manufacturer. Dispose of used batteries according to the manufacturer's instructions and your local government's recycling or disposal directives.*

### **Attention:**

*Il y a un risque d'explosion si la batterie est remplacée de façon incorrecte. Ne la remplacer qu'avec le même modèle ou équivalent recommandé par le constructeur. Recycler les batteries usées en accord avec les instructions du fabricant et les directives gouvernementales de recyclage.*

## Table Contents

<b>QBiX-Lite Industrial Embedded System</b>	<b>1</b>
<b>Quick Start Guide</b>	<b>1</b>
Copyright Notice .....	2
Acknowledgement .....	3
Packing List.....	4
About this Document.....	5
Safety Precautions .....	6
FCC Statement.....	8
<b>Chapter 1 - Product Specifications</b>	<b>11</b>
1.1 Specifications .....	13
	<b>15</b>
<b>Chapter 2 – QBiX-Lite-AMDA1605H-A1 (QL-1605A-SI)</b>	<b>15</b>
<b>Industrial Embedded System Kit</b>	<b>15</b>
2.1 Dimension .....	16
2.2 Getting Familiar with Your Unit.....	17
2.3 A) Wireless Module: How to safely install the Module (Wireless Module inclusion may vary based on local distribution) .....	19
2.4 B) Memory Installation: DDR4 SO-DIMM .....	20
2.5 Antenna Installation (Antenna inclusion may vary based on local distribution) .....	21
2.6 DB9 COM Pin Define .....	22
2.7 Support .....	23

2.8	Safety and Regulatory Information.....	24
<b>Chapter 3 – Hardware Information</b>		<b>25</b>
3.1	Jumpers and Connectors .....	26
3.2.1	BKL_CN (Back light brightness control connector).....	29
3.2.2	SPK_OUT (Speaker out connector).....	30
3.2.3	F_Audio (Audio line-out port) .....	31
3.2.4	SODIMM1, SODIMM2 (DDR4 SO-DIMM slot#1/slot#2) .....	32
3.2.5	SATAPW (SATA 6 Gb/s power connector) .....	33
3.2.6	SATA (SATA 6 Gb/s connector) .....	34
3.2.7	FUSB2_2 (USB 2.0 header).....	35
3.2.8	FUSB2_1 (USB 2.0 header).....	36
3.2.9	GPIO_CNT (General Purpose input/output header) ...	37
3.2.10	SYS_PANEL (Front panel header) .....	38
3.2.11	M2E (M.2 E-key for WiFi NGFF) .....	39
3.2.12	M2M (M.2 M key for NVME/SATA).....	39
3.2.13	AT_CN (AT/ATX power mode select jumper) .....	40
3.2.14	HDMI/eDP_CN (HDMI/eDP mode select jumper) .....	41
3.2.15	JCOM2 (COM2 RI pin RI/5V/12V Select) .....	42
3.2.16	JCOM1 (COM1 RI pin RI/5V/12V Select).....	43
3.2.17	COM1 (Serial port header).....	44
3.2.18	COM2 (Serial port header).....	45
3.2.19	COM3 (Serial port header).....	46

3.2.20	COM4 (Serial port header).....	47
3.2.21	MPCIE (Mini PCIE for 3G/4G module).....	48
3.2.22	DC IN (DC IN 1 x 4 pin power connector) .....	49
3.2.23	EDP (eDP Connector) .....	50
3.2.24	CPU_FAN (System FAN Connector) .....	51
3.2.25	SYS_FAN (System FAN Connector) .....	52
3.2.26	Battery (Battery Connector) .....	53
3.2.27	IO Connector Information .....	54



# Chapter 1

---

## Chapter 1 - Product Specifications

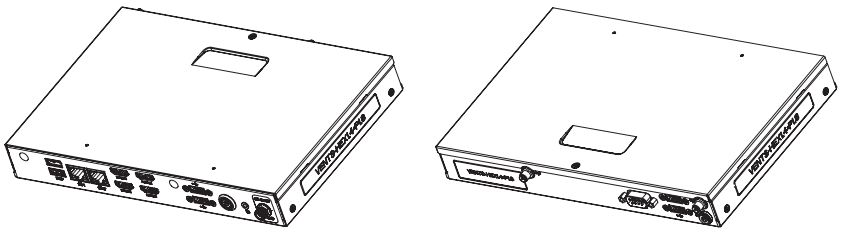

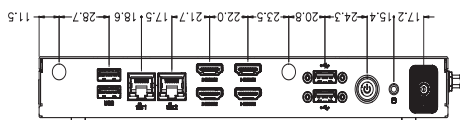
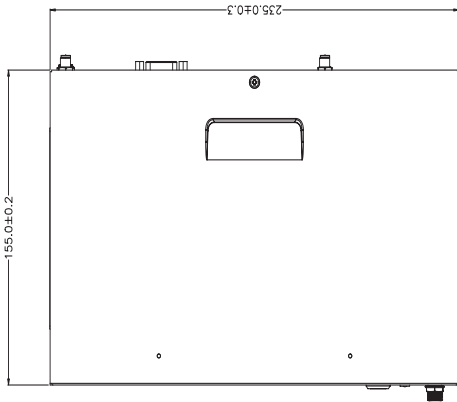
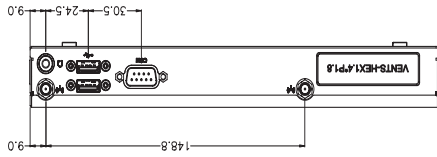
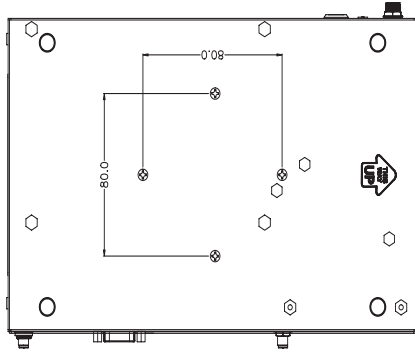

## 1.1 Specifications

System	QBiX-Lite-AMDA1605H-A1 (QL-1605A-SI)
Dimension	System Size : 234W x 155D x 30H (mm)
CPU	AMD Ryzen™ V1605B Embedded Processor 14nm, 4 cores, 8 threads, up to 3.6GHz, TDP 25W 2MB of shared L2 plus 4MB of shared L3 total
Chipset	SoC
Memory	2 x DDR4 SO-DIMM sockets, Max. Capacity 32 GB Support Dual channel DDR4 2400 MHz memory modules
Ethernet	2 x GbE LAN Ports (Realtek® RTL8111HS)
Graphic support	Integrated Graphics Processor - AMD Radeon™ Vega 8 Graphics: 4 x HDMI 2.0 ports, supporting a maximum resolution of 4096x2160 @60Hz *Support EDID emulation with AMD graphic driver/utility
Audio	Realtek® Audio Codec
Storage	1 x 2.5" HDD/SSD (SATA 6Gb/s)
Expansion Slots	1 x 2280 M.2 M-Key (PCIe x4, SATA 6Gb/s) 1 x 2230 M.2 E-Key (WiFi/BT) 1 x Full-size Mini PCIe with SIM slot (PCIe x1 + USB2.0) -- support 3G module
Front I/O	2 x RJ45 LAN Ports 2 x USB 3.2 Gen 1 2 x USB 2.0 4 x HDMI 1 x Power button with LED 1 x HDD LED 1 x Screw type DC Jack
Rear I/O	1 x COM Port (RS-232/422/485 & RI/5V/12V) 2 x USB 2.0 1 x Line out phone jack 2 x External Antenna Holes (Optional)
Side I/O	—
TPM	Onboard TPM 2.0 security chip INFINEON SLB9665TT2.0
Power	+9V~36VDC (Adapter 19V/65W)

System	QBiX-Lite-AMDA1605H-A1 (QL-1605A-SI)
Operation Temperature	Operating temperature: 0°C to 50°C Operating humidity: 0-90% (non-condensing) Non-operating temperature: -20°C to 70°C Non-operating humidity: 0%-95% (non-condensing) Use wide temperature range memory and storage
Vibration During Operation	Operation: IEC 60068-2-64, 1 Grms, random, 5 ~ 500 Hz, 1 hr / Per Axis, with SSD/M.2 2242 Non-operation: IEC 60068-2-6, 2 G, Sine, 10 ~ 500 Hz, 1 Oct/min, 1 hr / Per Axis
Shock During Operation	Operation: IEC 60068-2-27, 50 G, half sine, 11 ms duration, With SSD
Packaging Content	Carton size: 481 x 300 x 375 (mm) Packing Capacity: 5pcs  Including: Power cord (Optional, by region) x 1 PSU ADP 19V 65W 100-240VAC x 1 (25EP0-1065W1-A3S) Bracket Wall Mount x 1 (25HB1-SD4000-R0R) Screw For Wall Mount M3.0*L6.0 x 4 (25KS9-130600-S0R) Screw For HDD #2-M3x4L x 4 (25KS2-13004G-S0R) M.2 Standoff x 1 (12KSF-F10303-20R) Screw I Head For M.2 Standoff M2x4L x 1 (25KSG-130048-S0R) SATA Cable x 1 (25CF4-160000-S9R) M.2 Heatsink x 1 (25ST1-1231Z1-S7R) WiFi PAD x 1 (25ST3-200060-T5R)
Order Information	System : 6BQL1605AMR-SI

## Chapter 2

---

### Chapter 2 – QBiX-Lite-AMDA1605H-A1 (QL-1605A-SI) Industrial Embedded System Kit

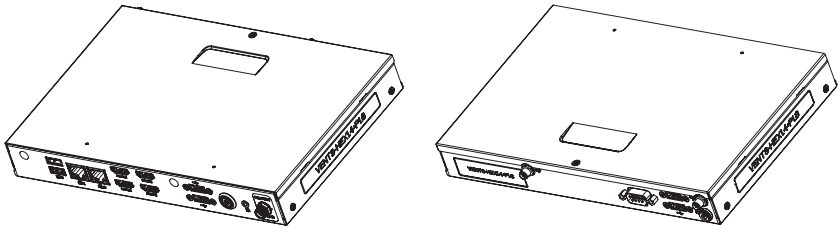

# 2.1 Dimension

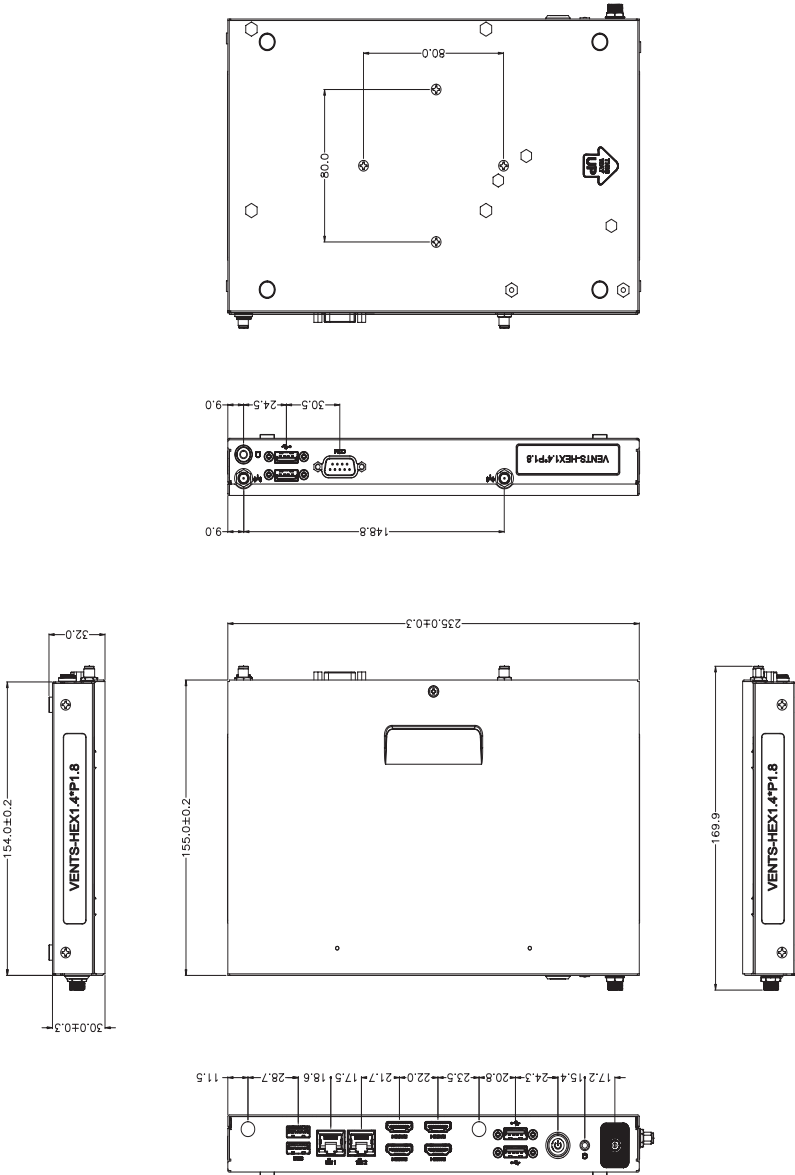

## 2.2 Getting Familiar with Your Unit

### [Front I/O Side]

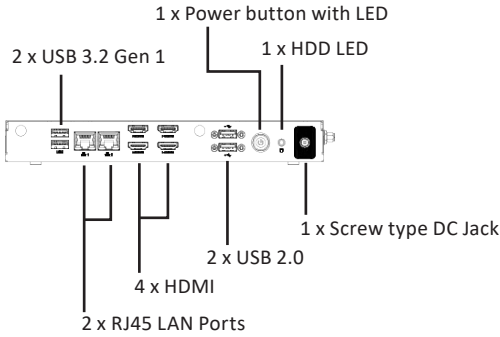

### [Left Side]



### [Rear I/O Side]

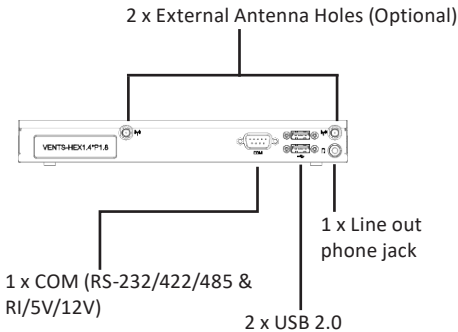

### [Right Side]



## [Install]

- \* Before opening the case, make sure to unplug the power cord.
- \* Before Connecting the power, make sure to fasten the case securely.

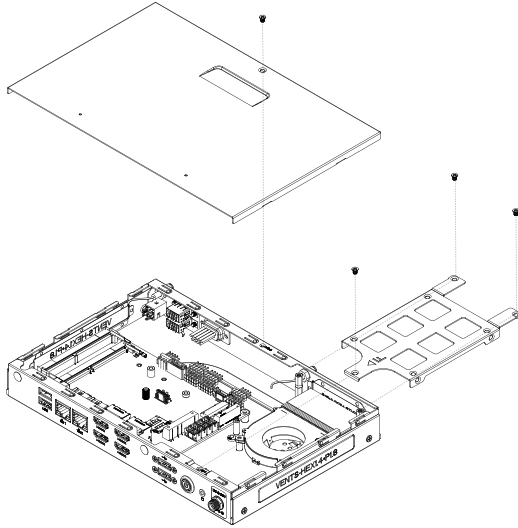

## [Bottom PCB Side]

	Information
A	2 x DDR4 SO-DIMM sockets, Max. Capacity 32 GB, Support Dual Channel DDR4 2400 MHz
B	1 x Full-size miniPCIe with SIM slot

	Information
C	1 x 2230 M.2 E-Key
D	1 x 2280 M.2 M-Key (PCIe x4, SATA 6Gb/s)
E	2.5" Hard drive/ SSD

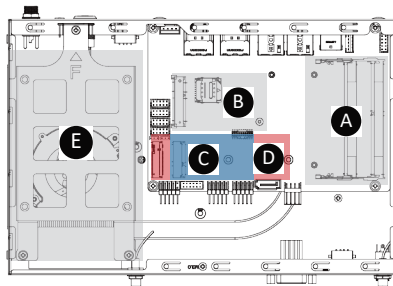

## 2.3 A) Wireless Module: How to safely install the Module (Wireless Module inclusion may vary based on local distribution)

1

Carefully insert the wireless module into the M.2 slot

小心地將無線模組安裝於M.2插槽中。

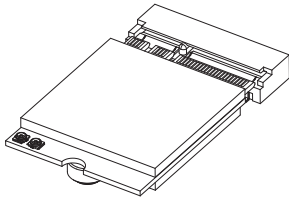

2

Lock the screw in the middle.

鎖入固定於無線模組中央頂端的螺絲。

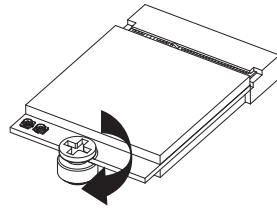

3

Install the antenna on the left side of the connection wireless module down.

向下安裝連結於無線模組左側頂端天線。

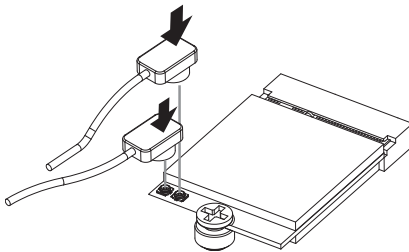

## 2.4 B) Memory Installation: DDR4 SO-DIMM

---

①

Carefully insert SO-DIMM memory modules.

小心地由下至上將 SO-DIMM 記憶體安裝於記憶體插槽。

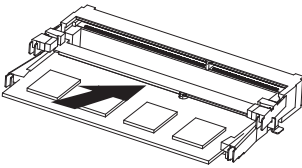

②

Push down until the modules click into place.

當記憶體固定於插槽後，再輕輕下壓至定點。

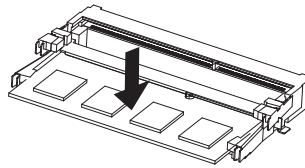

③

Carefully insert SO-DIMM memory modules.

安裝下層記憶體後，重覆前述動作安裝上層記憶體。

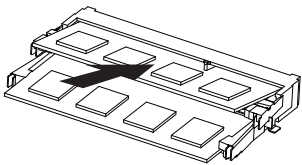

④

Push down until the modules click into place.

當記憶體固定於插槽後，再輕輕下壓至定點。

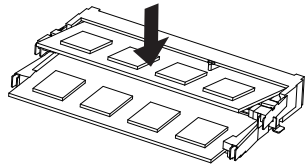

## 2.5 Antenna Installation (Antenna inclusion may vary based on local distribution)

①

Carefully insert the antennas into the connectors.  
小心地將天線插入天線插孔中。

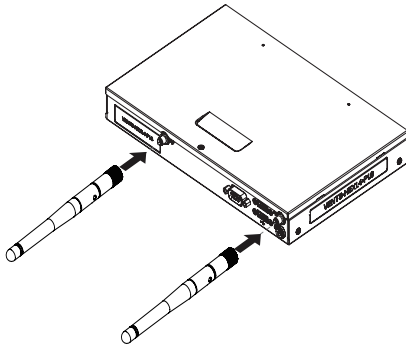

②

Turn the antennas clockwise until they are completely secure on the connectors.  
握住天線接頭底端，按順時針方向將天線旋入插孔中牢牢固定。

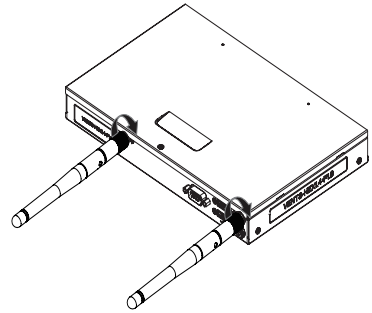

③

Flip up the antenna heads so that they are perpendicular to the machine.  
栓緊後請將天線拉起朝上呈垂直狀。

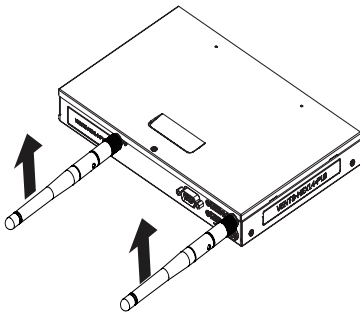

## 2.6 DB9 COM Pin Define

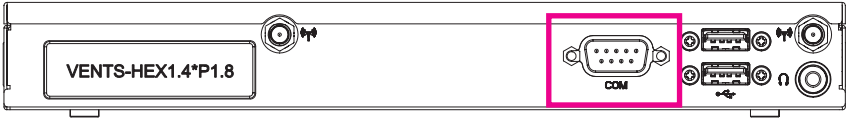

### DB9 COM

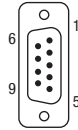

25CF8-180620-S9R

Pin No.	Pin Define
1	DCD
2	RXD
3	TXD
4	DTR
5	GND
6	DSR
7	RTS
8	CTS
9	RI

## 2.7 Support

---

- For AVL list, go to: <http://www.gigaipc.com>
- To download the latest drivers, go to: <http://www.gigaipc.com>
- For product support, go to: <http://www.gigaipc.com>

## 2.8 Safety and Regulatory Information

---

Risk of explosion if the battery is replaced with an incorrect type. Batteries should be recycled where possible.

Disposal of used Batteries must be in accordance with local environmental regulations.

Failure to use the included Power Adapter may violate regulatory compliance and may expose the user to safety hazards.

**HDMI**™  
HIGH DEFINITION MULTIMEDIA INTERFACE



At the end of its serviceable life, this product should not be treated as household or general waste. It should be handed over to the applicable collection point for the recycling of electrical and electronic equipment, or returned to the supplier for disposal.

# Chapter 3

---

## Chapter 3 – Hardware Information

# 3.1 Jumpers and Connectors

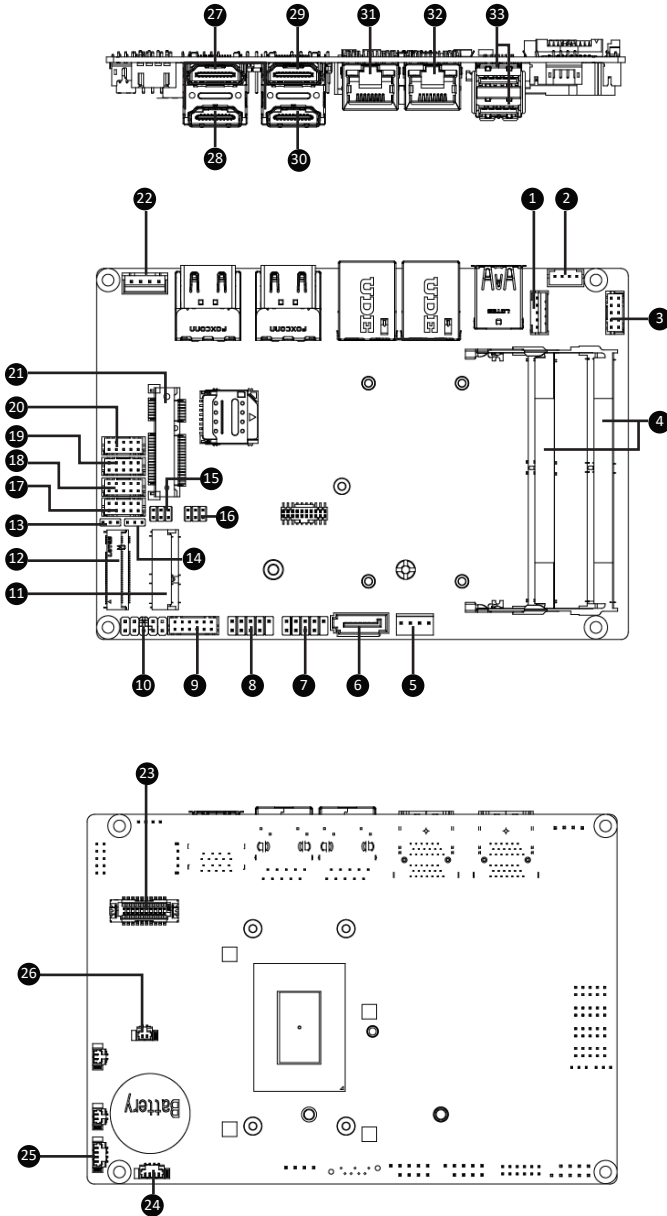

	Code	Description
1	BKL_CN	Backlight brightness control connector
2	SPKR	Speaker out connector
3	F_AUDIO	Audio line-out port
4	SODIMM1, SODIMM2	DDR4 SO-DIMM slot#1/slot#2
5	SATAPWR	SATA 6 Gb/s Power Connector
6	SATA	SATA 6 Gb/s Connector
7	FUSB20_2	USB 2.0 header x 1
8	FUSB20_1	USB 2.0 header x 1
9	GPIO_CNT	General Purpose input/output header
10	SYS_PANEL	Front panel header
11	M2E	M.2 E-Key for WiFi NGFF
12	M2M	M.2 M Key for NVME/SATA
13	AT_CN	AT/ATX power mode select jumper
14	HDMI/eDP_CN	HDMI/eDP mode select jumper
15	JCOM2	COM2 RI pin RI/5V/12V Select
16	JCOM1	COM1 RI pin RI/5V/12V Select
17	COM4	RS-232 COM Serial port header
18	COM3	RS-232 COM Serial port header
19	COM2	COM2 RS-232/422/485, and 5V/12V/RI COM Serial port header
20	COM1	COM1 RS-232/422/485, and 5V/12V/RI COM Serial port header
21	MPCIE	Mini PCIE for 3G/4G module

	Code	Description
22	DC_IN	DC IN 1x4-pin power connector
23	EDP	eDP connector (*The HDMI3's Function is Disabled, during eDP Function Enabled)
24	CPU_FAN	CPU Fan connector
25	SYS_FAN	System Fan connector
26	Battery	Battery connector
27	HDMI1	HDMI Connector
28	HDMI2	HDMI Connector
29	HDMI3	HDMI Connector (*The HDMI3's Function is Disabled, during eDP Function Enabled)
30	HDMI4	HDMI Connector
31	LAN2	LAN Connectors
32	LAN1	LAN Connectors
33	USB3	USB 3.2 Gen 1

## 3.2.1 BKL\_CN (Back light brightness control connector)

1

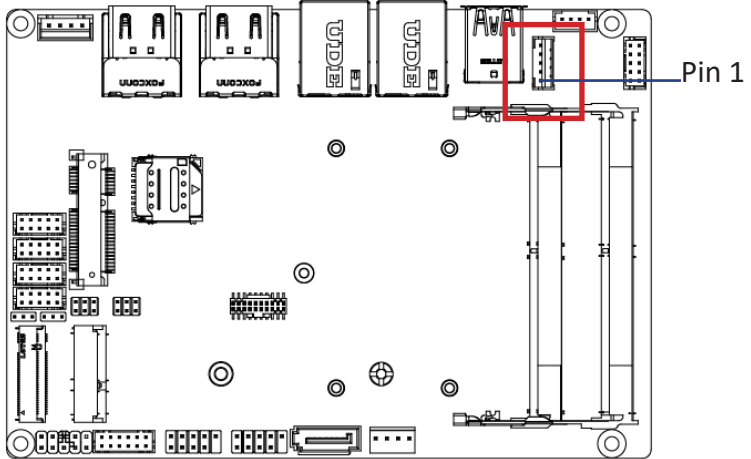

Back light brightness control connector



Pin No.	Definition
1	12V
2	GND
3	eDP_BKLTEN
4	eDP_BKLTCTL
5	5V

## 3.2.2 SPK\_OUT (Speaker out connector)

2

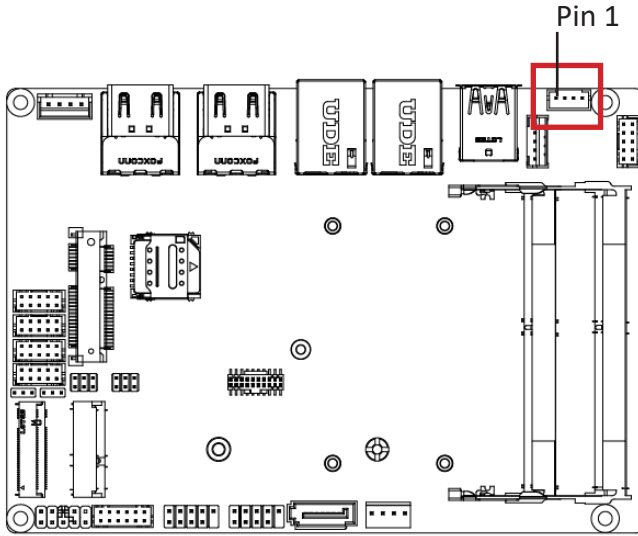

Speaker out connector



Pin No.	Definition
1	Speaker Out R+
2	Speaker Out R-
3	Speaker Out L-
4	Speaker Out L+

## 3.2.3 F\_Audio (Audio line-out port)

3

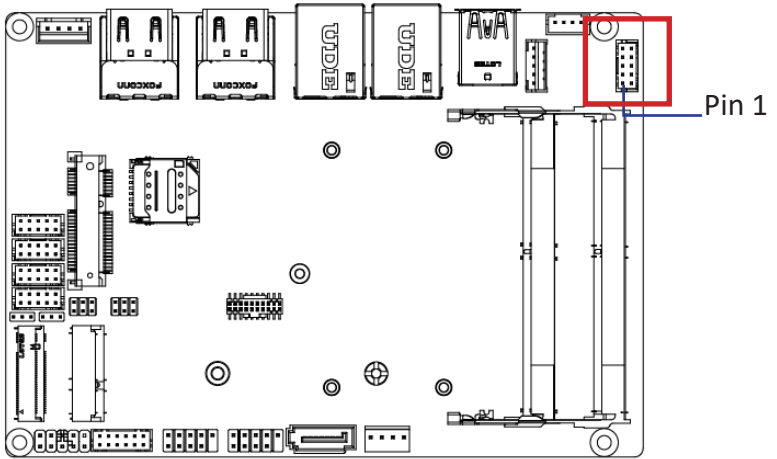

F\_Audio Connector



Pin No.	Definition	Pin No.	Definition
1	F_MIC1_L	2	GND
3	F_MIC1_R	4	F_AUDIO_DET
5	F_HP_R	6	F_MIC_JD
7	FAUDIO_JD	8	NC
9	F_HP_L	10	F_HP_JD

### 3.2.4 SODIMM1, SODIMM2 (DDR4 SO-DIMM slot#1/ slot#2)

4

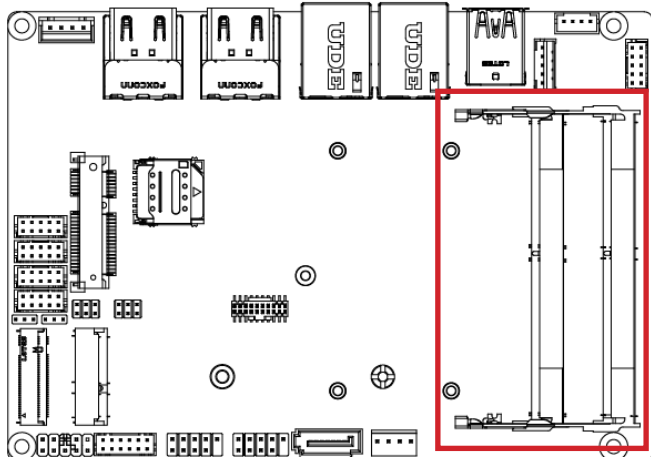

## 3.2.5 SATAPW (SATA 6 Gb/s power connector)

5

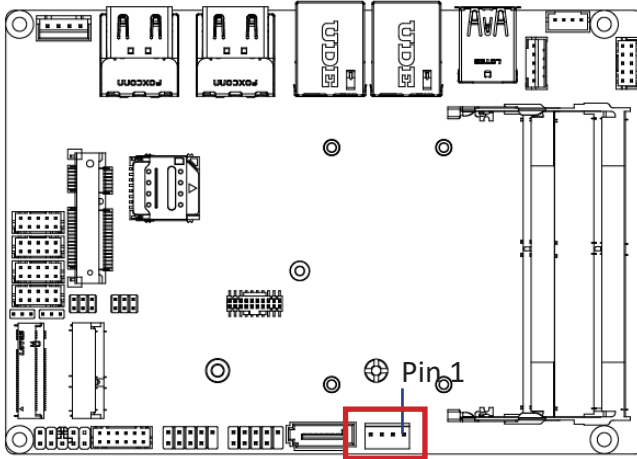

Hard Disk Power Connector



Pin No.	Definition
1	12V
2	GND
3	GND
4	5V

### 3.2.6 SATA (SATA 6 Gb/s connector)

6

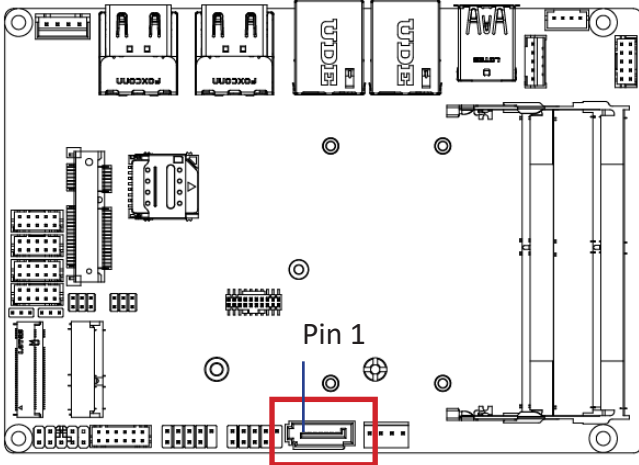

**SATA 6Gb/s Connector**

Pin No.	Definition
1	GND
2	TXP
3	TXN
4	GND
5	RXN
6	RXP
7	GND

## 3.2.7 FUSB2\_2 (USB 2.0 header)

7

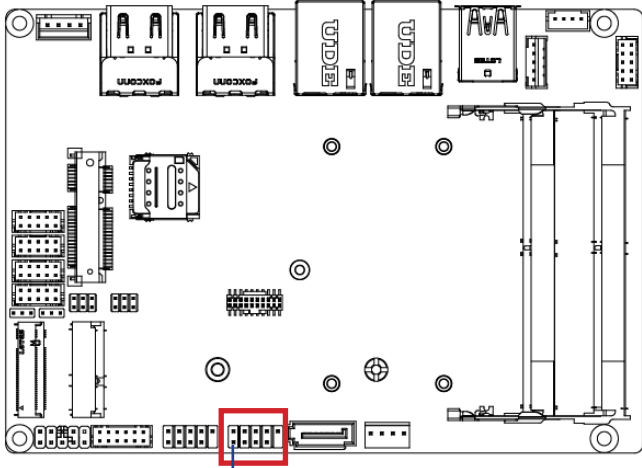

Pin 1

USB 2.0 Header



Pin No.	Definition
1	5V
2	5V
3	DX-
4	DY-
5	DX+
6	DY+
7	GND
8	GND
9	No Pin
10	No Connect

### 3.2.8 FUSB2\_1 (USB 2.0 header)

8

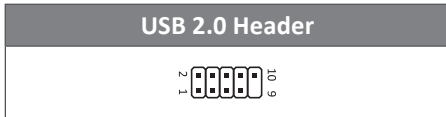
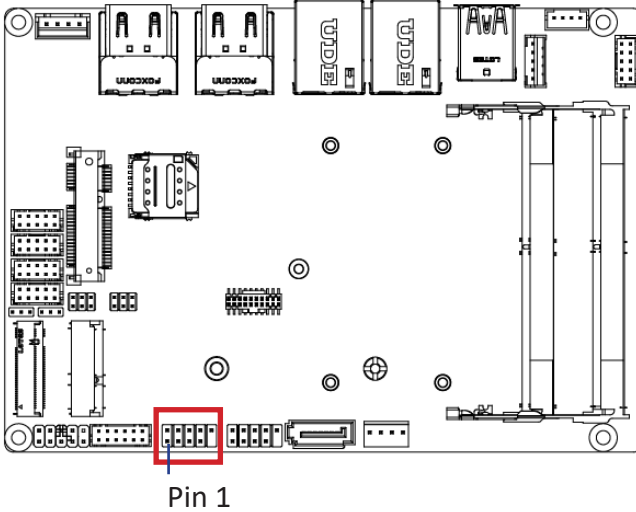

Pin No.	Definition
1	5V
2	5V
3	DX-
4	DY-
5	DX+
6	DY+
7	GND
8	GND
9	No Pin
10	No Connect

## 3.2.9 GPIO\_CNT (General Purpose input/output header)

9

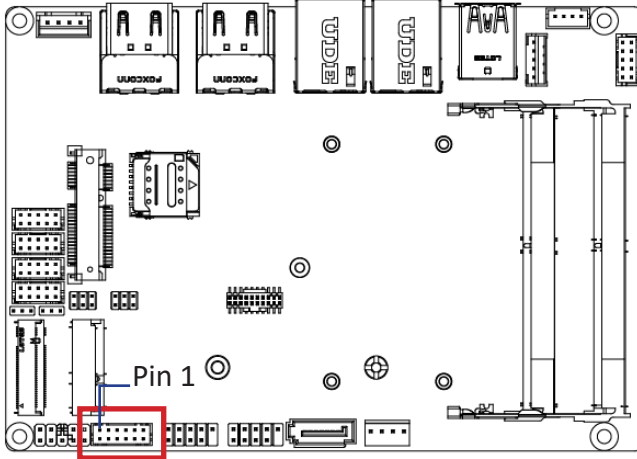

GPIO Connector



Pin No.	Definition	Pin No.	Definition
1	GPI_0	2	GPO_0
3	GPI_1	4	GPO_1
5	GPI_2	6	GPO_2
7	GPI_3	8	GPO_3
9	SMB_IO_CLK	10	SMB_IO_DATA
11	3.3V	12	GND

### 3.2.10 SYS\_PANEL (Front panel header)

10

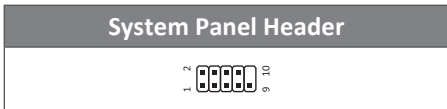
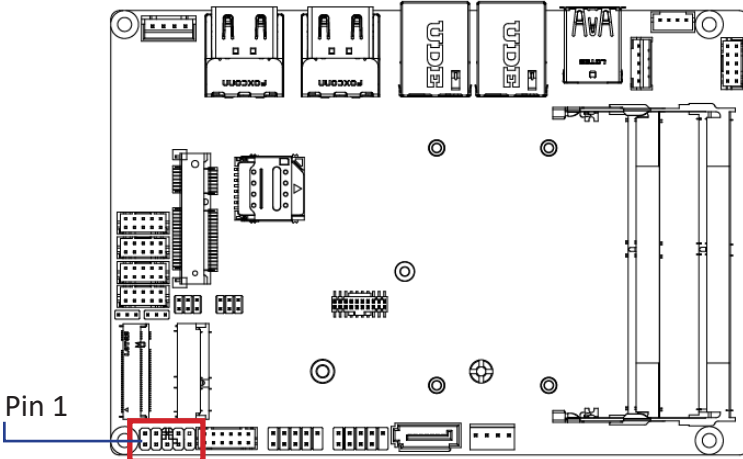

Pin No.	Definition
1	HDD LED+
2	Power LED+
3	HDD LED-
4	Power LED-
5	GND
6	Power Button+
7	Reset Button
8	Power Button-
9	No Connect
10	No Pin

## 3.2.11 M2E (M.2 E-key for WiFi NGFF)

11

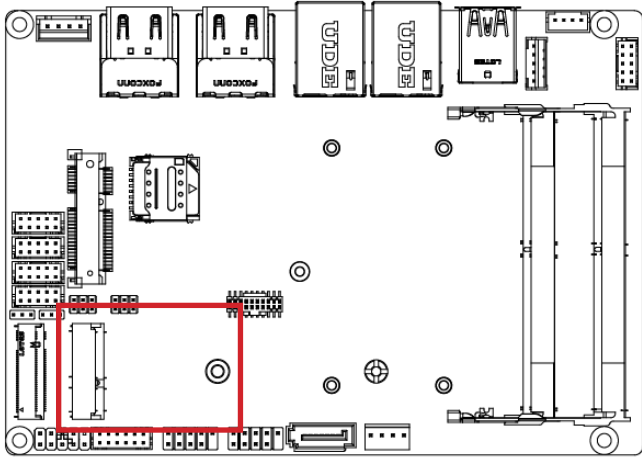

## 3.2.12 M2M (M.2 M key for NVME/SATA)

12

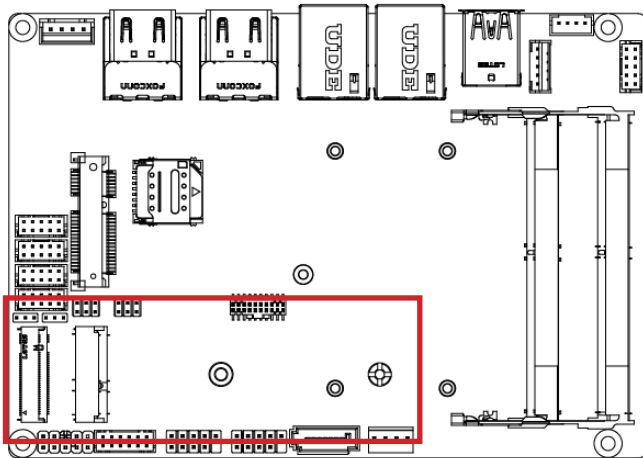

### 3.2.13 AT\_CN (AT/ATX power mode select jumper)

13

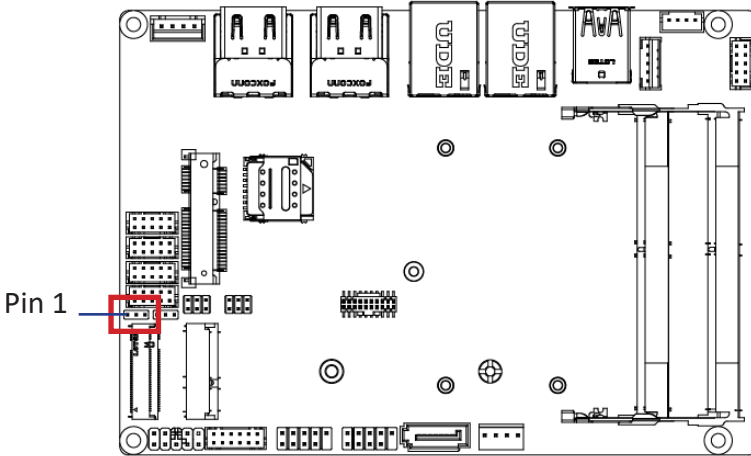

AT/ATX power mode select jumper	
	1-2 Close : AT mode.
	2-3 Close : ATX mode. (Default setting)

Pin No.	Definition
1	AT
2	COMM
3	ATX

## 3.2.14 HDMI/eDP\_CN (HDMI/eDP mode select jumper)

14

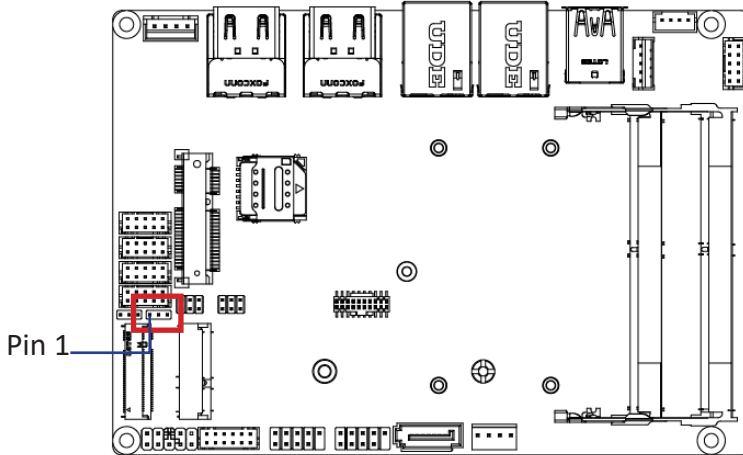

Pin 1

### HDMI/eDP mode select jumper

	1-2 Close: HDMI mode. (Default setting, HDMI3 I/O is Enable)
	2-3 Close: eDP mode. (HDMI3 I/O Port is Disable)

Pin No.	Definition
1	HDMI
2	COMM
3	eDP

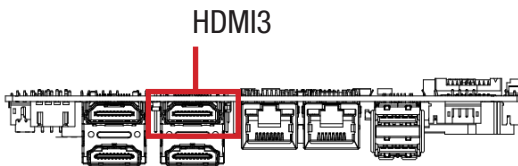

HDMI3

### 3.2.15 JCOM2 (COM2 RI pin RI/5V/12V Select)

15

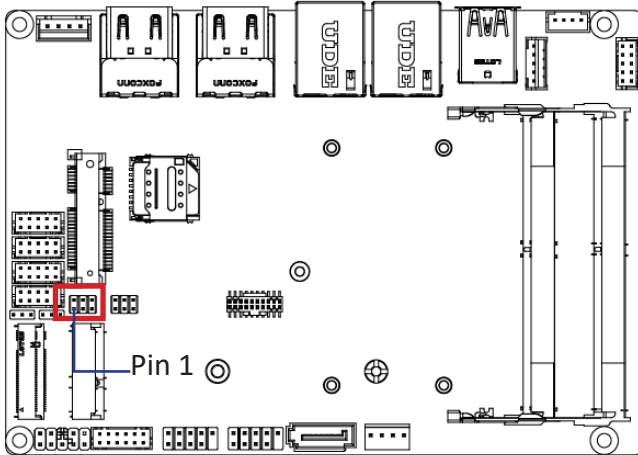

JCOM11 Jumper Select	
	1-2 Close: 5V (Power COM)
	3-4 Close: RI (Stand COM) Default
	5-6 Close: 12V (Power COM)

## 3.2.16 JCOM1 (COM1 RI pin RI/5V/12V Select)

16

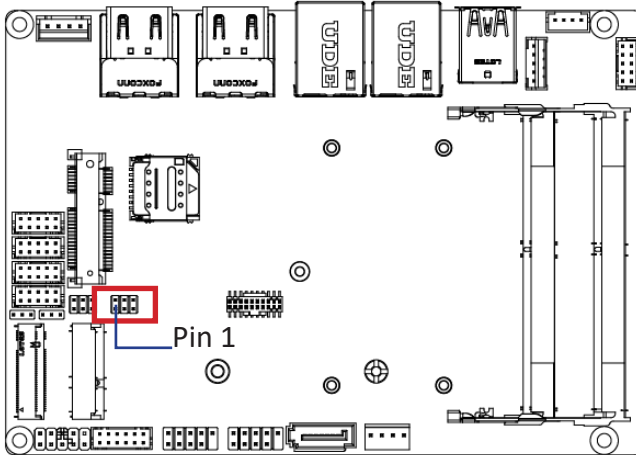

### JCOM11 Jumper Select

	1-2 Close: 5V (Power COM)
	3-4 Close: RI (Stand COM) Default
	5-6 Close: 12V (Power COM)

### 3.2.17 COM1 (Serial port header)

17

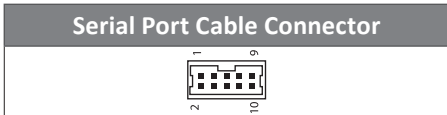
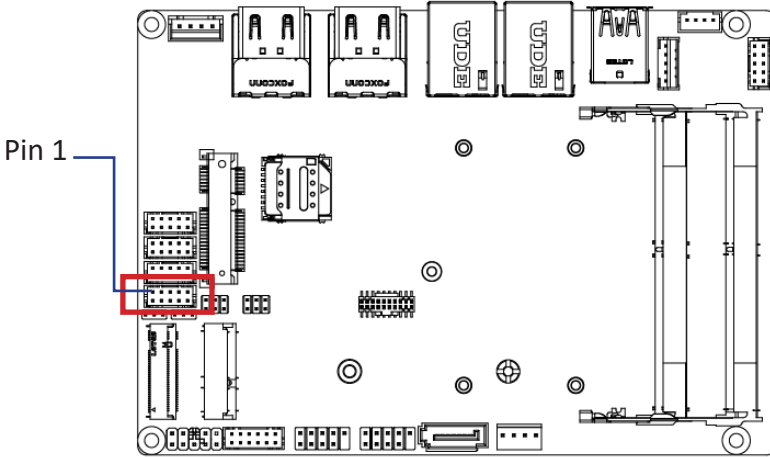

Pin No.	Definition
1	RXD
2	DCD
3	DTRD
4	TXD
5	DSR
6	GND
7	CTS
8	RTS
9	No Connect
10	RI/5V/12V

## 3.2.18 COM2 (Serial port header)

18

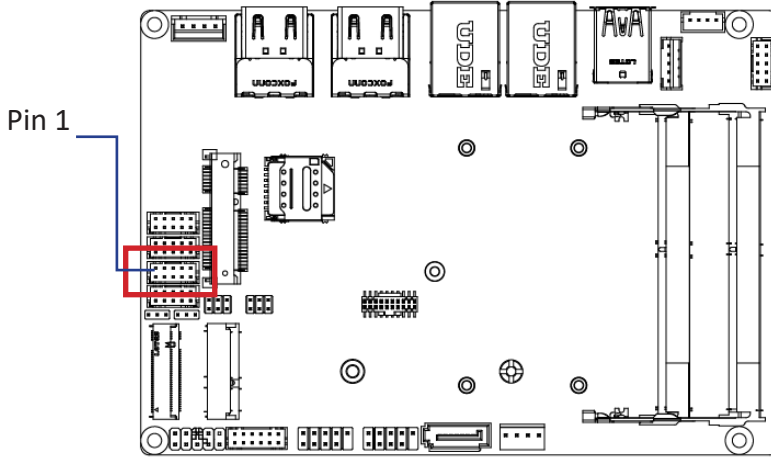

Serial Port Cable Connector



Pin No.	Definition
1	RXD
2	DCD
3	DTRD
4	TXD
5	DSR
6	GND
7	CTS
8	RTS
9	No Connect
10	RI/5V/12V

### 3.2.19 COM3 (Serial port header)

19

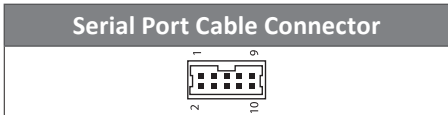
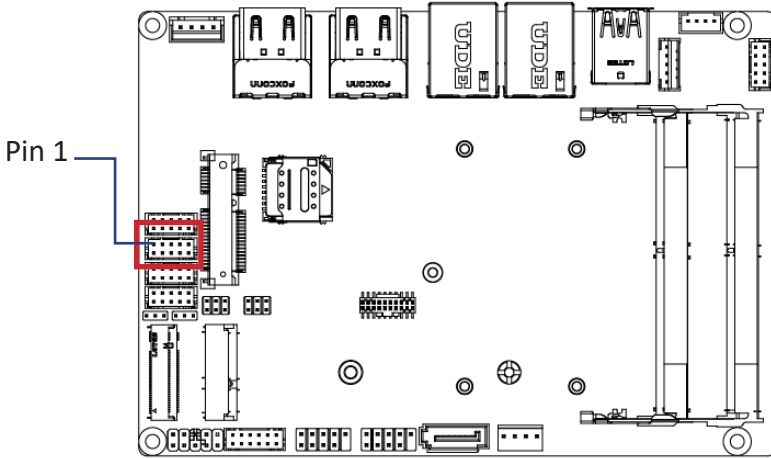

Pin No.	Definition
1	RXD
2	DCD
3	DTRD
4	TXD
5	DSR
6	GND
7	CTS
8	RTS
9	No Connect
10	RI/5V/12V

## 3.2.20 COM4 (Serial port header)

20

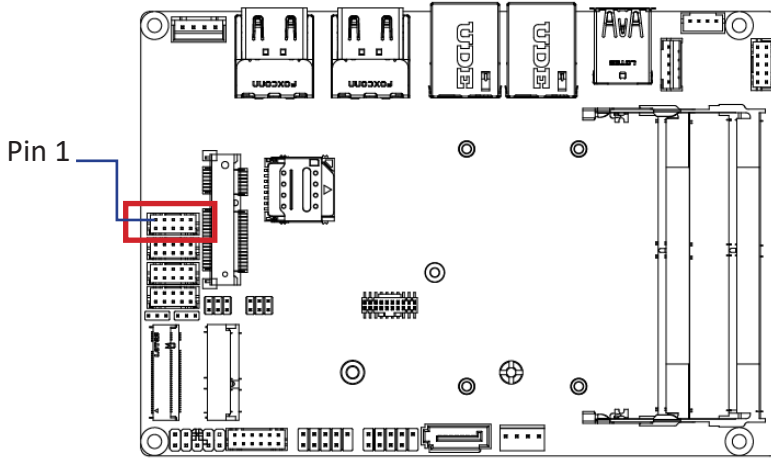

Serial Port Cable Connector



Pin No.	Definition
1	RXD
2	DCD
3	DTRD
4	TXD
5	DSR
6	GND
7	CTS
8	RTS
9	No Connect
10	RI/5V/12V

### 3.2.21 MPCIE (Mini PCIE for 3G/4G module)

21

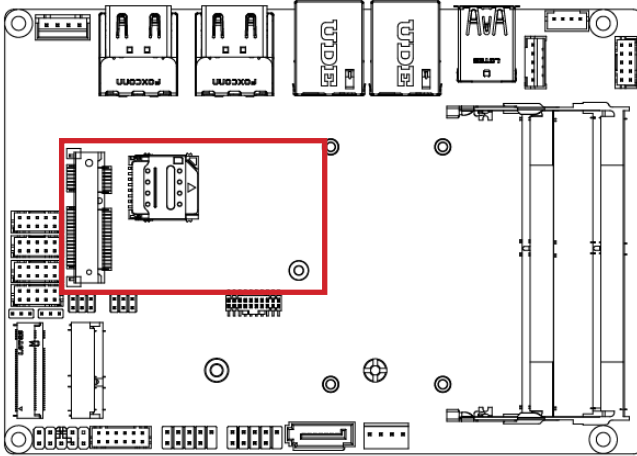

## 3.2.22 DC IN (DC IN 1 x 4 pin power connector)

22

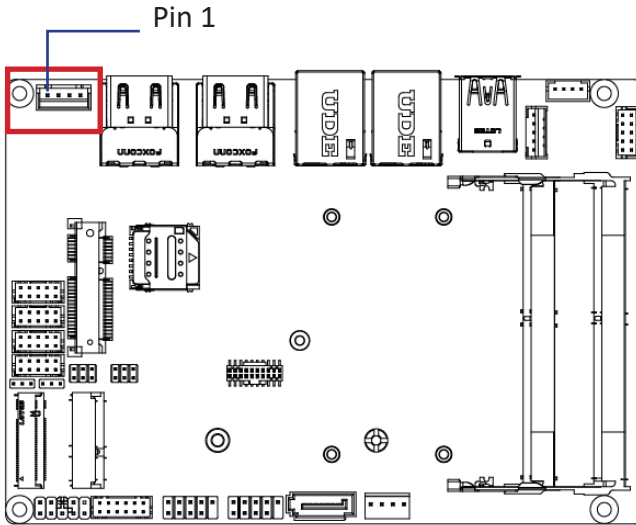

DC IN power connector

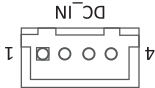

Pin No.	Definition
1	GND
2	DCIN
3	DCIN
4	GND

### 3.2.23 EDP (eDP Connector)

23

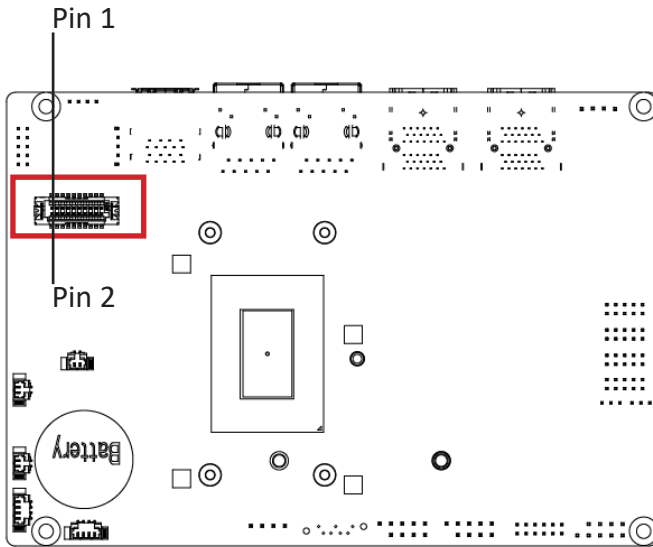

Pin No.	Definition	Pin No.	Definition
1	GND	2	GND
3	EDP_TXN0	4	EDP_TXN3
5	EDP_TXP0	6	EDP_TXP3
7	GND	8	eDP_DET#
9	EDP_TXN1	10	GND
11	EDP_TXP1	12	EDP_AUXN
13	GND	14	EDP_AUXP
15	EDP_TXN2	16	GND
17	EDP_TXP2	18	EDP_HPD
19	5V	20	3.3V

## 3.2.24 CPU\_FAN (System FAN Connector)

24

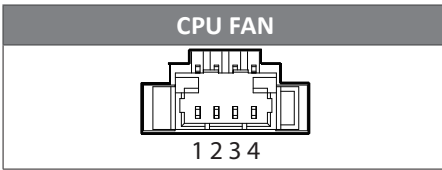
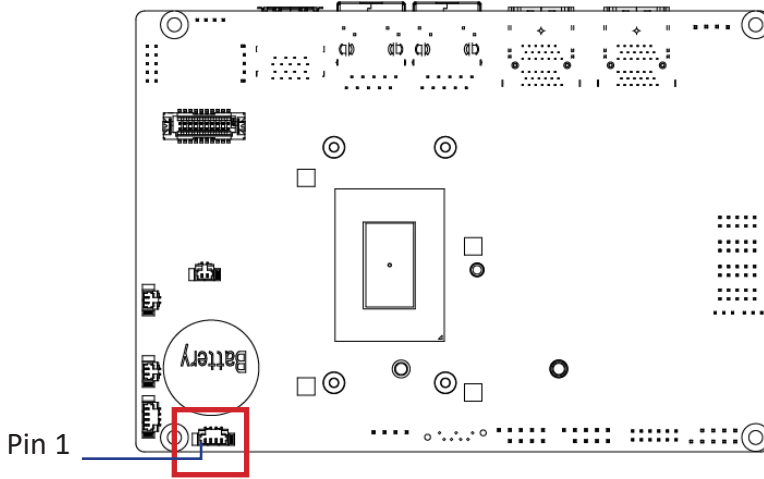

Pin No.	Definition
1	GND
2	12V
3	FANTECH
4	PWM

### 3.2.25 SYS\_FAN (System FAN Connector)

25

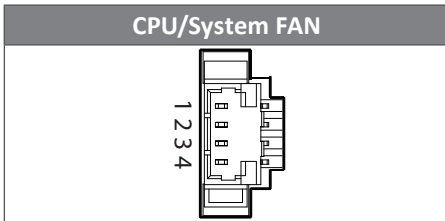
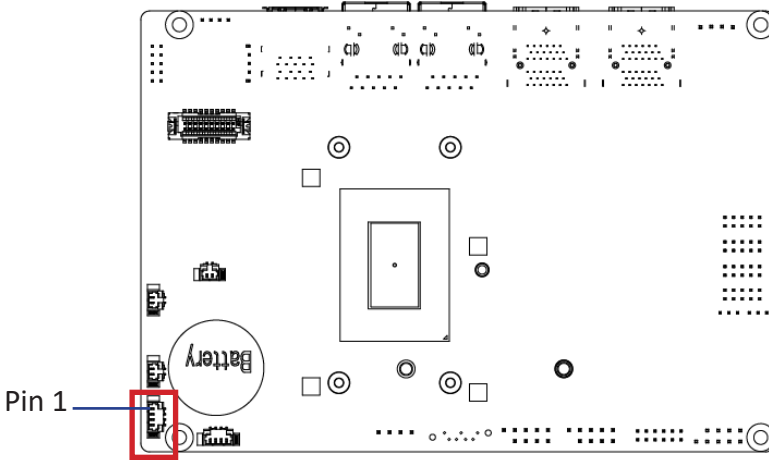

Pin No.	Definition
1	GND
2	12V
3	FANTECH
4	PWM

## 3.2.26 Battery (Battery Connector)

26

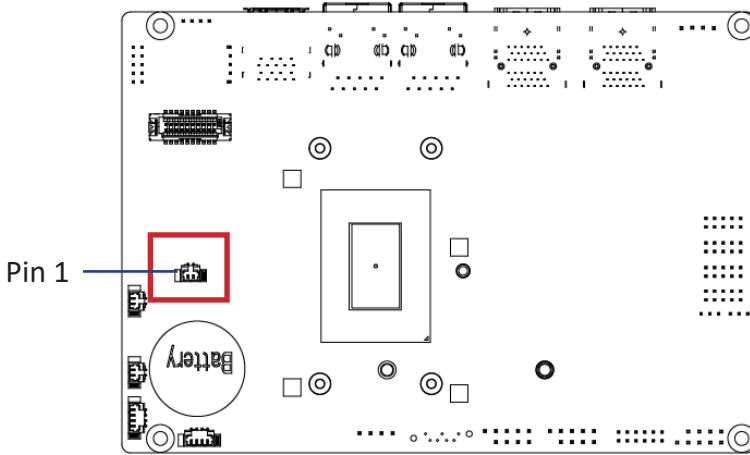

Battery Cable Connector

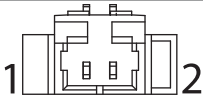

Pin No.	Definition
1	3.3V RTC
2	GND

### 3.2.27 IO Connector Information

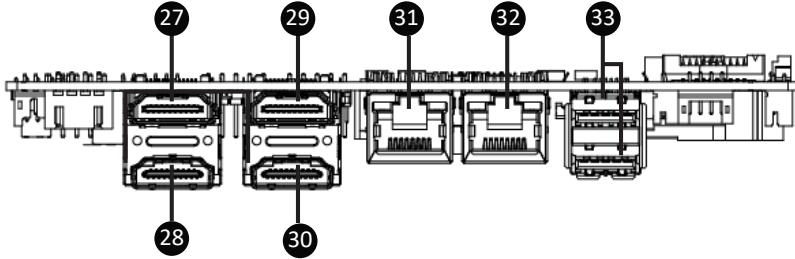

	Code	Description
27	HDMI 1	HDMI Connector
28	HDMI 2	HDMI Connector
29	HDMI 3	HDMI Connector (*The HDMI's Function is Disabled, during eDP Function Enabled)
30	HDMI 4	HDMI Connector
31	LAN2	LAN Connectors
32	LAN1	LAN Connectors
33	USB3	USB 3.2 Gen 1