

QBiX-Pro-AMDA1605H-A1 (QP-1605A-SI)

QBiX-Pro Industrial Embedded System
Quick Start Guide

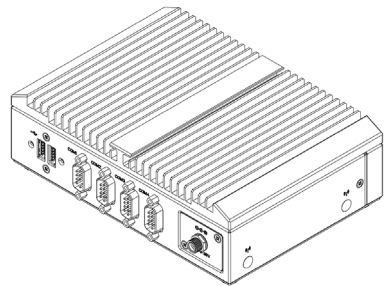
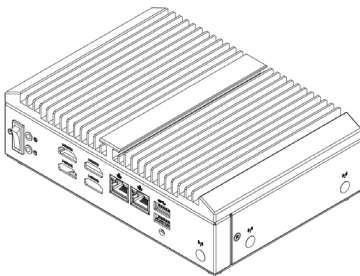

Copyright Notice

This document is copyrighted, 2019. All rights are reserved. The original manufacturer reserves the right to make improvements to the products described in this manual at any time without notice.

No part of this manual may be reproduced, copied, translated, or transmitted in any form or by any means without the prior written permission of the original manufacturer. Information provided in this manual is intended to be accurate and reliable. However, the original manufacturer assumes no responsibility for its use, or for any infringements upon the rights of third parties that may result from its use.

The material in this document is for product information only and is subject to change without notice. While reasonable efforts have been made in the preparation of this document to assure its accuracy, GIGAIPC assumes no liabilities resulting from errors or omissions in this document, or from the use of the information contained herein.

GIGAIPC reserves the right to make changes in the product design without notice to its users.

Acknowledgement

All other products' name or trademarks are properties of their respective owners.

- AMD is trademark of Advanced Micro Devices.
- Microsoft Windows is a registered trademark of Microsoft Corp.
- Intel, Pentium, Celeron, and Xeon are registered trademarks of Intel Corporation
- Core, Atom are trademarks of Intel Corporation
- ITE is a trademark of Integrated Technology Express, Inc.
- IBM, PC/AT, PS/2, and VGA are trademarks of International Business Machines Corporation.

All other product names or trademarks are properties of their respective owners.

Packing List

Before setting up your product, please make sure the following items have been shipped:

Item	Quantity
System kit	1
19V / 65W adapter	1
Power cord (May vary based on local distribution)	1
Screw I Head For 2.5" HDD M3x8L (25KSG-130081-K1R)	4
SATA Cable (25CF4-170020-S9R)	1
Thermal pad for HDD (25ST3-200052-T5R)	2
Thermal Pad for WiFi module (25ST3-200060-T5R)	1
Thermal pad for DIMM2 (25ST3-200051-T5R)	1
Exsiccator (10g)	1

If any of these items are missing or damaged, please contact your distributor or sales representative immediately.

About this Document

This User's Manual contains all the essential information, such as detailed descriptions and explanations on the product's hardware and software features (if any), its specifications, dimensions, jumper/connector settings/definitions, and driver installation instructions (if any), to facilitate users in setting up their product.

Users may refer to the GIGAIPC.com for the latest version of this document.

Safety Precautions

Please read the following safety instructions carefully. It is advised that you keep this manual for future references

1. All cautions and warnings on the device should be noted.
2. Make sure the power source matches the power rating of the device.
3. Position the power cord so that people cannot step on it. Do not place anything over the power cord.
4. Always completely disconnect the power before working on the system's hardware.
5. No connections should be made when the system is powered as a sudden rush of power may damage sensitive electronic components.
6. If the device is not to be used for a long time, disconnect it from the power supply to avoid damage by transient over-voltage.
7. Always disconnect this device from any AC supply before cleaning.
8. While cleaning, use a damp cloth instead of liquid or spray detergents.
9. Make sure the device is installed near a power outlet and is easily accessible.
10. Keep this device away from humidity.
11. Place the device on a solid surface during installation to prevent falls
12. Do not cover the openings on the device to ensure optimal heat dissipation.

13. Watch out for high temperatures when the system is running.
14. Do not touch the heat sink or heat spreader when the system is running
15. Never pour any liquid into the openings. This could cause fire or electric shock.
16. As most electronic components are sensitive to static electrical charge, be sure to ground yourself to prevent static charge when installing the internal components. Use a grounding wrist strap and contain all electronic components in any static-shielded containers.
17. If any of the following situations arises, please the contact our service personnel:
 - i. Damaged power cord or plug
 - ii. Liquid intrusion to the device
 - iii. Exposure to moisture
 - iv. Device is not working as expected or in a manner as described in this manual
 - v. The device is dropped or damaged
 - vi. Any obvious signs of damage displayed on the device
- 18. DO NOT LEAVE THIS DEVICE IN AN UNCONTROLLED ENVIRONMENT WITH TEMPERATURES BEYOND THE DEVICE'S PERMITTED STORAGE TEMPERATURES (SEE CHAPTER 1) TO PREVENT DAMAGE.**

FCC Statement

Warning!



This device complies with Part 15 FCC Rules. Operation is subject to the following two conditions: (1) this device may not cause harmful interference, and (2) this device must accept any interference received including interference that may cause undesired operation.

Caution:

There is a danger of explosion if the battery is incorrectly replaced. Replace only with the same or equivalent type recommended by the manufacturer. Dispose of used batteries according to the manufacturer's instructions and your local government's recycling or disposal directives.

Attention:

Il y a un risque d'explosion si la batterie est remplacée de façon incorrecte. Ne la remplacer qu'avec le même modèle ou équivalent recommandé par le constructeur. Recycler les batteries usées en accord avec les instructions du fabricant et les directives gouvernementales de recyclage.

Table Contents

QBiX-Pro Industrial Embedded System	1
Quick Start Guide	
Copyright Notice	2
Acknowledgement	3
Packing List.....	4
About this Document.....	5
Safety Precautions	6
FCC Statement.....	8
Chapter 1 - Product Specifications	11
1.1 Specifications	13
Chapter 2 – QBiX-Pro-AMDA1605H-A1 (QP-1605A-SI) Industrial Embedded System Kit	15
2.1 Dimension	16
2.2 Getting Familiar with Your Unit.....	17
2.3 A) Wireless Module: How to safely install the Module (Wireless Module inclusion may vary based on local distribution)	19
2.4 B) Memory Installation: DDR4 SO-DIMM	20
2.5 Antenna Installation (Antenna inclusion may vary based on local distribution)	21
2.7 Support	23
2.8 Safety and Regulatory Information.....	24
Chapter 3 – Hardware Information	25
3.1 Jumpers and Connectors	26
3.2.1 BKL_CN (Backlight Control header)	29

3.2.2	SPK_OUT (Speaker out connector)	30
3.2.3	F_Audio (Front panel audio header)	31
3.2.4	SODIMM1, SODIMM2 (DDR4 SO-DIMM slot)	32
3.2.5	SATAPW (SATA power connector)	33
3.2.6	SATA (SATA 6Gb/s connector)	34
3.2.7	F_USB2_2 (USB 2.0 header)	35
3.2.8	F_USB2_1 (USB 2.0 header)	36
3.2.9	GPIO_CNT (General purpose input/output header) ...	37
3.2.10	SYS_PANEL (Front panel header)	38
3.2.11	M2E (M.2 E-key for WiFi NGFF)	39
3.2.12	M2M (M.2 M key for NVME/SATA)	39
3.2.13	AT_CN (AT/ATX mode select jumper)	40
3.2.14	HDMI/eDP_CN (HDMI/eDP mode select jumper)	41
3.2.15	JCOM2 (COM2 RI pin RI/5V/12V Select)	42
3.2.16	JCOM1 (COM1 RI pin RI/5V/12V Select)	43
3.2.17	COM1 (Serial port header, RS-232/422/485 & RI/5V/12V)	44
3.2.18	COM2 (Serial port header, RS-232/422/485 & RI/5V/12V)	45
3.2.19	COM3 (Serial port header, RS-232)	46
3.2.20	COM4 (Serial port header, RS-232)	47
3.2.21	MPCIE (Mini PCIE for 3G/4G module)	48
3.2.22	DC IN (DC IN 1 x 4 pin power connector)	49
3.2.23	Battery (Battery Connector)	50
3.2.24	EDP (eDP Connector)	51
3.2.25	CPU_FAN (CPU FAN Connector)	52
3.2.26	SYS_FAN (System FAN Connector)	53
3.2.27	IO Connector Information	54

Chapter 1

Chapter 1 - Product Specifications

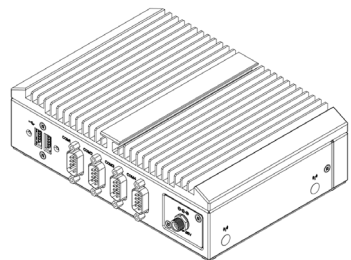
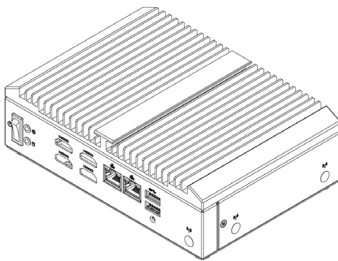

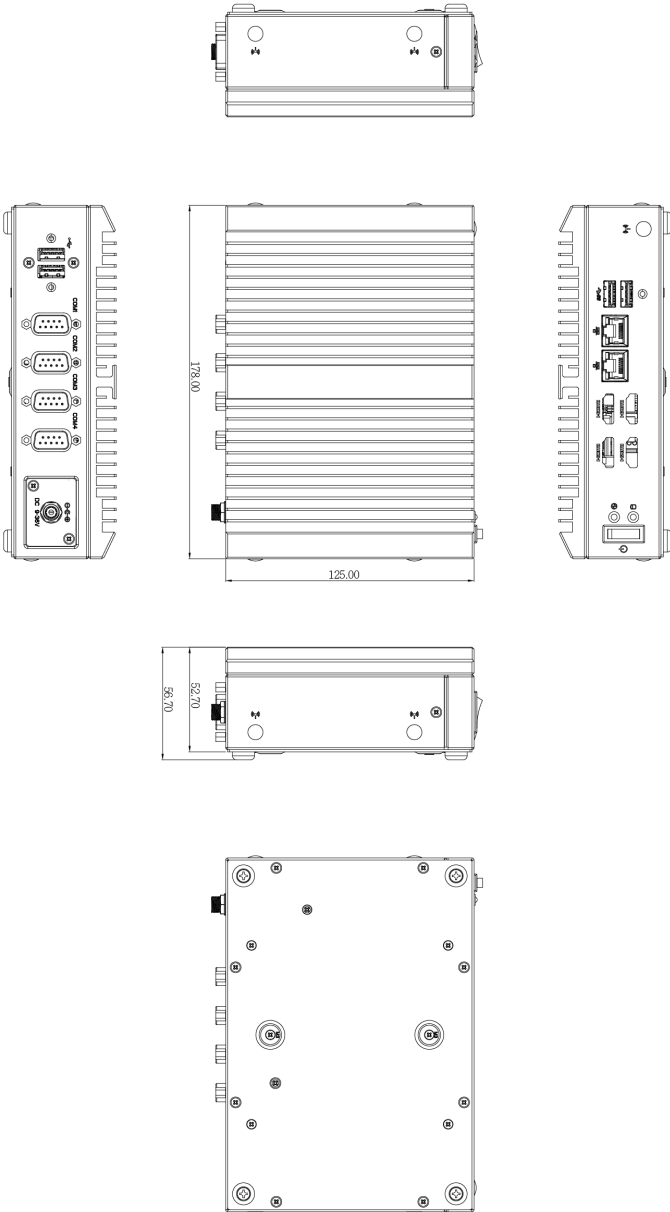

1.1 Specifications

System	QBiX-Pro-AMDA1605H-A1 (QP-1605A-SI)
Dimension	System Size : 178W x 125D x 52.7H (mm)
CPU	AMD® RYZEN™ V1605B Embedded Processor 14nm, 4 cores, 8 threads, 2.0 GHz, up to 3.6GHz TDP 25W 2MB of shared L2 plus 4MB of shared L3 total
Chipset	SoC
Memory	2 x DDR4 SO-DIMM sockets, Max. Capacity 32 GB Support Dual channel DDR4 2400MHz memory modules
Ethernet	2 x GbE LAN Ports (Realtek® RTL8111HS)
Graphic support	Integrated Graphics Processor - AMD Radeon™ Vega 8 Graphics 4 x HDMI port, supporting a maximum resolution of 4096x2160 @60Hz *Support EDID emulation with AMD graphic driver/utility (4 independent display outputs)
Audio	Realtek® Audio Codec
Storage	1 x 2.5" HDD/SSD (SATA 6Gb/s)
Expansion Slots	1 x 2280 M.2 M-Key (PCIe x4, SATA 6Gb/s) 1 x 2230 M.2 E-Key (WiFi/BT) 1 x Full-size Mini PCIe with SIM slot (PCIe x1 + USB2.0) -- support 3G module
Front I/O	2 x RJ45 LAN Ports 2 x USB 3.2 Gen 1 4 x HDMI 1 x Power switch 1 x Power & HDD LED
Rear I/O	2 x USB 2.0 2 x COM Ports (RS-232/422/485 & RI/5V/12V) 2 x COM Ports (RS-232) 1 x Screw Type DC Jack
Side I/O	2 x External Antenna Holes (Optional)
TPM	Onboard TPM 2.0 security chip INFINEON SLB9665TT2.0
Power	+9V~36VDC (Adapter 19V/65W)

System	QBiX-Pro-AMDA1605H-A1 (QP-1605A-SI)
Operation temperature	Operating temperature: 0°C to 50°C Operating humidity: 0-90% (non-condensing) Non-operating temperature: -20°C to 70°C Non-operating humidity: 0%-95% (non-condensing) Use wide temperature range memory and storage
Vibration During Operation	Operation: IEC 60068-2-64, 5 Grms, random, 5 ~ 500 Hz, 1 hr / Per Axis, With SSD/M.2 2242 Non-operation: IEC 60068-2-6, 2 G, Sine, 10 ~ 500 Hz, 1 Oct/ min, 1 hr / Per Axis
Shock During Operation	Operation: IEC 60068-2-27, 50 G, half sine, 11 ms duration, With SSD
Packaging Content	Carton size: 505 x 333 x 231 (mm) Packing Capacity: 5pcs Including: Screw I Head for 2.5" HDD M3x8L x 4 (P/N: 25KSG-130081-K1R) Thermal Pad x 2 (P/N: 25ST3-200052-T5R) Thermal Pad x 1 (P/N: 25ST3-200060-T5R) Thermal Pad x 1 (P/N: 25ST3-200051-T5R) SATA Cable x 1 (P/N: 25CF4-170020-S9R) Power Cord : Optional (by region) Power ADP 19V 65W 100-240VAC x 1 (P/N: 25EP0-1065W1-A3S)
Order Information	System: 6BQP1605AMR-SI (Box packing)

Chapter 2

Chapter 2 – QBiX-Pro-AMDA1605H-A1 (QP-1605A-SI) Industrial Embedded System Kit

2.2 Getting Familiar with Your Unit

[Front Side]

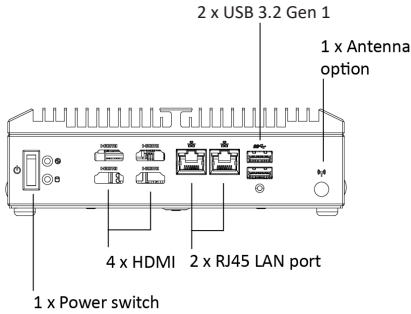

[Left Side]

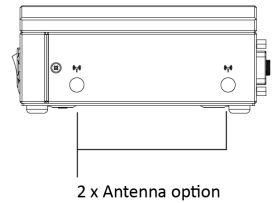

[Rear Side]

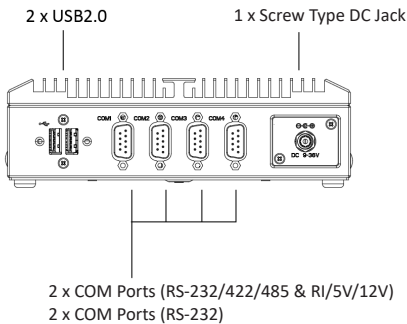

[Right Side]

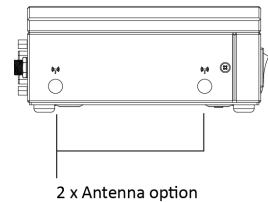

[Install]

- * Before opening the case, make sure to unplug the power cord.
- * 打開機殼前，請確實移除電源。
- * Before Connecting the power, make sure to fasten the case securely.
- * 接上電源前，請確實將機殼完整鎖附。

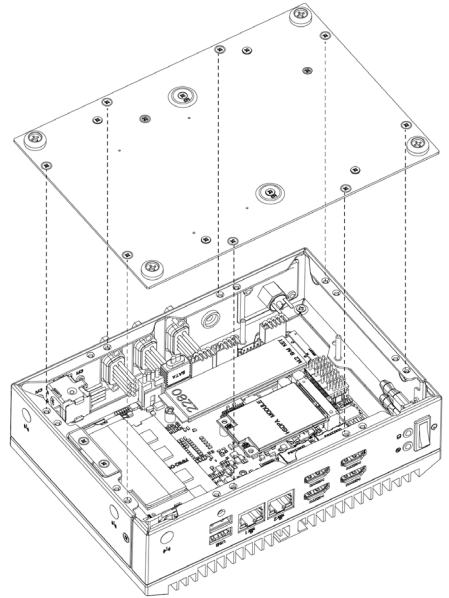
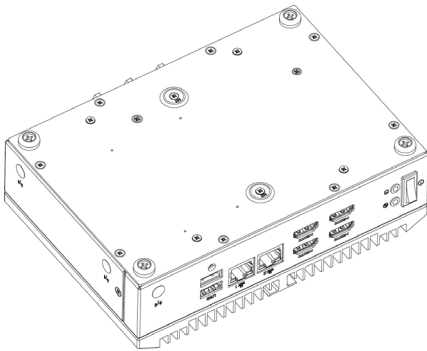

[Bottom PCB Side]

Information	
A	1 x Mini-PCIe slot (PCIe x1+USB2.0) with SIM Slot
B	2 x DDR4 SO-DIMM sockets, Max. Capacity 32 GB

Information	
C	1* M.2 slot(Support NGFF-2230 Wifi/BT) 1* M.2 slot(Supports NGFF-2280 SATA/PCIe x4)
D	2.5" Hard drive/SSD

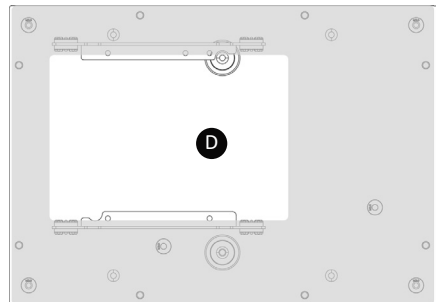
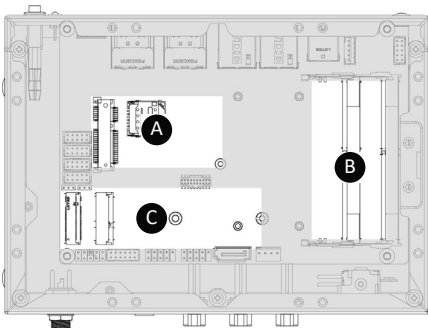

2.3 A) Wireless Module: How to safely install the Module (Wireless Module inclusion may vary based on local distribution)

1

Carefully insert the wireless module into the M.2 slot

小心地將無線模組安裝於M.2插槽中。

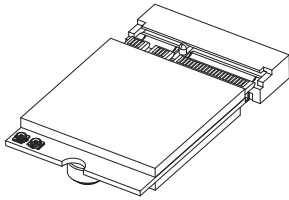

2

Lock the screw in the middle.

鎖入固定於無線模組中央頂端的螺絲。

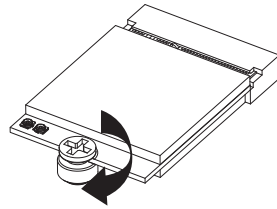

3

Install the antenna on the left side of the connection wireless module down.

向下安裝連結於無線模組左側頂端天線。

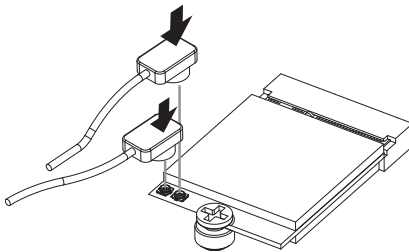

2.4 B) Memory Installation: DDR4 SO-DIMM

①

Carefully insert SO-DIMM memory modules.

小心地由下至上將 SO-DIMM 記憶體安裝於記憶體插槽。

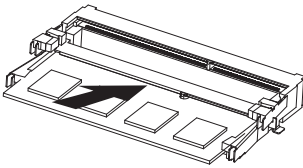

②

Push down until the modules click into place.

當記憶體固定於插槽後，再輕輕下壓至定點。

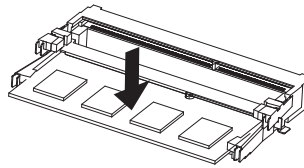

③

Carefully insert SO-DIMM memory modules.

安裝下層記憶體後，重覆前述動作安裝上層記憶體。

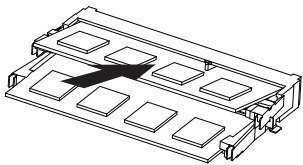

④

Push down until the modules click into place.

當記憶體固定於插槽後，再輕輕下壓至定點。

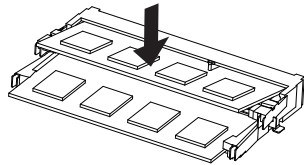

2.5 Antenna Installation (Antenna inclusion may vary based on local distribution)

①

Carefully insert the antennas into the connectors.
小心地將天線插入天線插孔中。

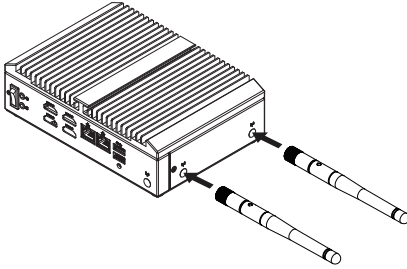

②

Turn the antennas clockwise until they are completely secure on the connectors.
握住天線接頭底端，按順時針方向將天線旋入插孔中牢牢固定。

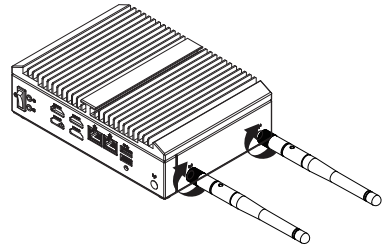

③

Flip up the antenna heads so that they are perpendicular to the machine.
栓緊後請將天線拉起朝上呈垂直狀。

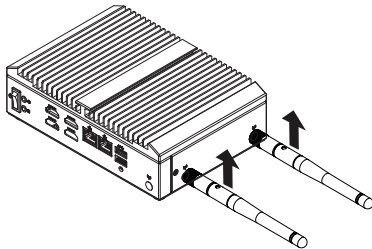

2.7 Support

- For AVL list, go to: <http://www.gigaipc.com>
- To download the latest drivers, go to: <http://www.gigaipc.com>
- For product support, go to: <http://www.gigaipc.com>

2.8 Safety and Regulatory Information

Risk of explosion if the battery is replaced with an incorrect type. Batteries should be recycled where possible.

Disposal of used Batteries must be in accordance with local environmental regulations.

Failure to use the included Power Adapter may violate regulatory compliance and may expose the user to safety hazards.

HDMI™
HIGH DEFINITION MULTIMEDIA INTERFACE



At the end of its serviceable life, this product should not be treated as household or general waste. It should be handed over to the applicable collection point for the recycling of electrical and electronic equipment, or returned to the supplier for disposal.

Chapter 3

Chapter 3 – Hardware Information

3.1 Jumpers and Connectors

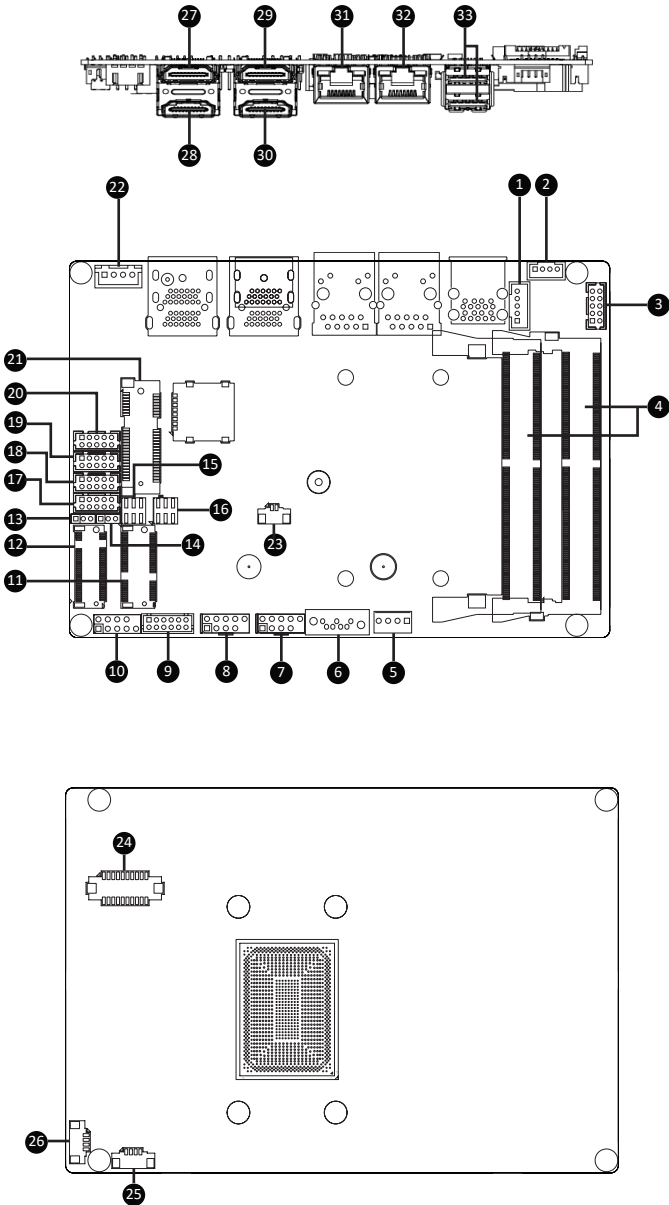

	Code	Description
1	BKL_CN	Backlight Control header
2	SPKR	Speaker out connector
3	F_AUDIO	Front panel audio header
4	SODIMM1, SODIMM2	DDR4 SO-DIMM slot
5	SATAPWR	SATA power connector
6	SATA	SATA 6Gb/s connector
7	F_USB2_2	USB 2.0 header
8	F_USB2_1	USB 2.0 header
9	GPIO_CNT	General Purpose input/output header
10	SYS_PANEL	Front panel header
11	M2E	M.2 E-Key for WiFi NGFF
12	M2M	M.2 M Key for NVME/SATA
13	AT_CN	AT/ATX mode select jumper
14	HDMI/eDP_CN	HDMI/eDP mode select jumper
15	JCOM2	COM2 RI pin RI/5V/12V Select
16	JCOM1	COM1 RI pin RI/5V/12V Select
17	COM1	COM1 Serial port header (RS-232/422/485, RI/5V/12V)
18	COM2	COM2 Serial port header (RS-232/422/485, RI/5V/12V)
19	COM3	COM3 Serial port header (RS-232)
20	COM4	COM4 Serial port header (RS-232)
21	MPCIE	Mini PCIE for 3G/4G module

	Code	Description
22	DC_IN	DC IN 1x4-pin power connector
23	Battery	Battery connector
24	EDP	eDP connector (*The HDMI3's Function is Disabled, during eDP Function Enabled)
25	CPU_FAN	CPU Fan connector
26	SYS_FAN	System Fan connector
27	HDMI1_2	HDMI 2 connector
28		HDMI 1 connector
29	HDMI3_4	HDMI 4 connector (*The HDMI 4's function is Disabled, during eDP Function Enabled)
30		HDMI 3 connector
31	LAN2	LAN connectors
32	LAN1	LAN connectors
33	USB3	USB 3.2 Gen 1

3.2.1 BKL_CN (Backlight Control header)

1

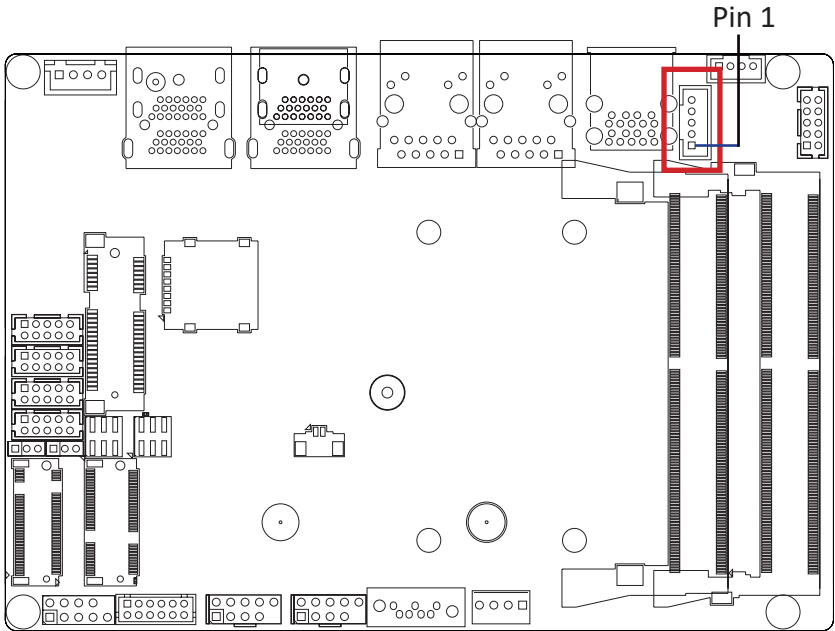

Backlight Control header



Connector PN

721-81-05TW00

A2001WV-05P146

Vendor

PINREX

JOINT-TECH

Pin No.	Definition
1	12V
2	GND
3	eDP_BKLTEN
4	eDP_BKLTCTL
5	5V

3.2.2 SPK_OUT (Speaker out connector)

2

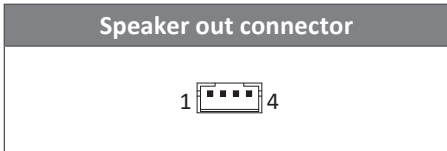
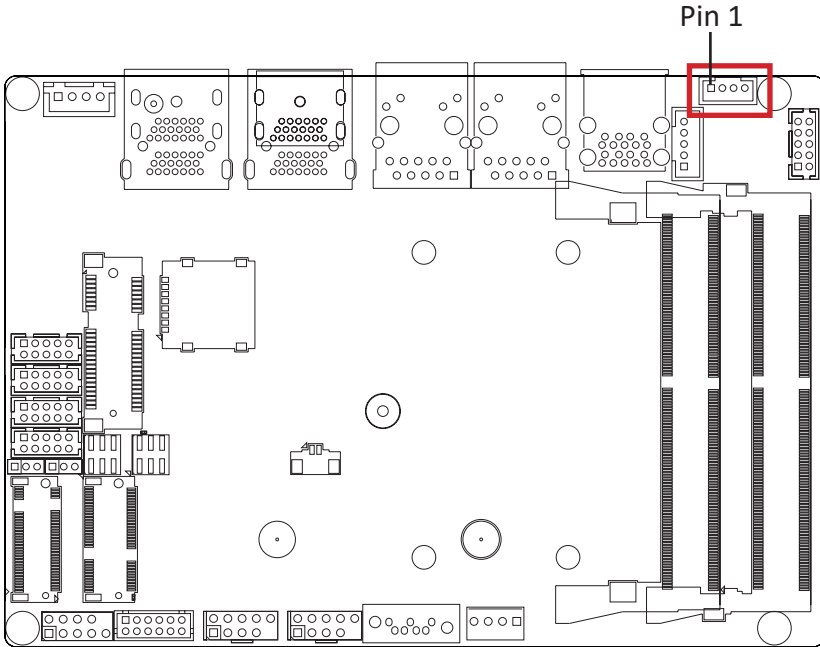

Connector PN	Vendor
721-81-045W00	PINREX
A2001WV-04P146	JOINT-TECH

Pin No.	Definition
1	Speaker Out R+
2	Speaker Out R-
3	Speaker Out L-
4	Speaker Out L+

3.2.3 F_Audio (Front panel audio header)

3

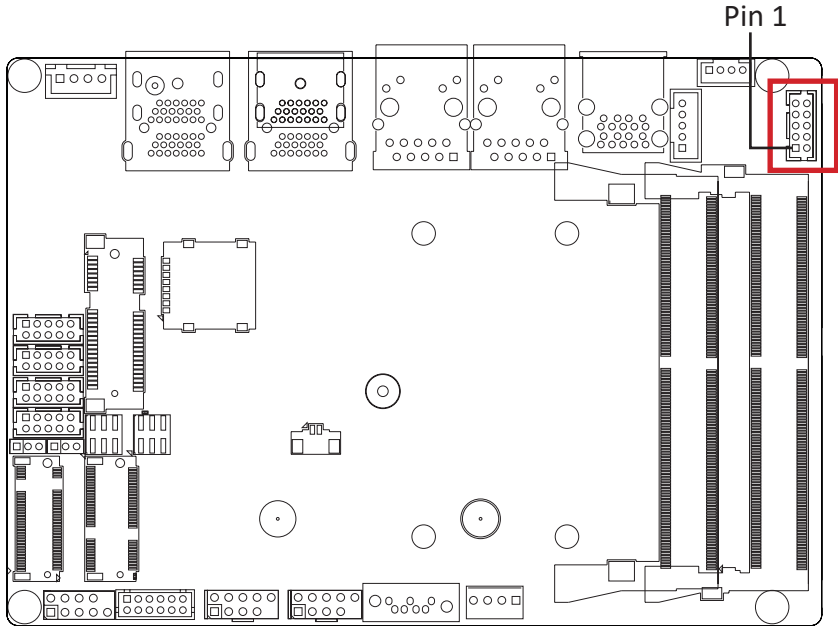

Front panel audio header



Connector PN	Vendor
725-81-10TW00	PINREX
A2004WV-2X05P46	JOINT-TECH

Pin No.	Definition	Pin No.	Definition
1	F_MIC1_L	2	GND
3	F_MIC1_R	4	F_AUDIO_DET
5	F_HP_R	6	F_MIC_JD
7	FAUDIO_JD	8	NC
9	F_HP_L	10	F_HP_JD

3.2.4 SODIMM1, SODIMM2 (DDR4 SO-DIMM slot)

4

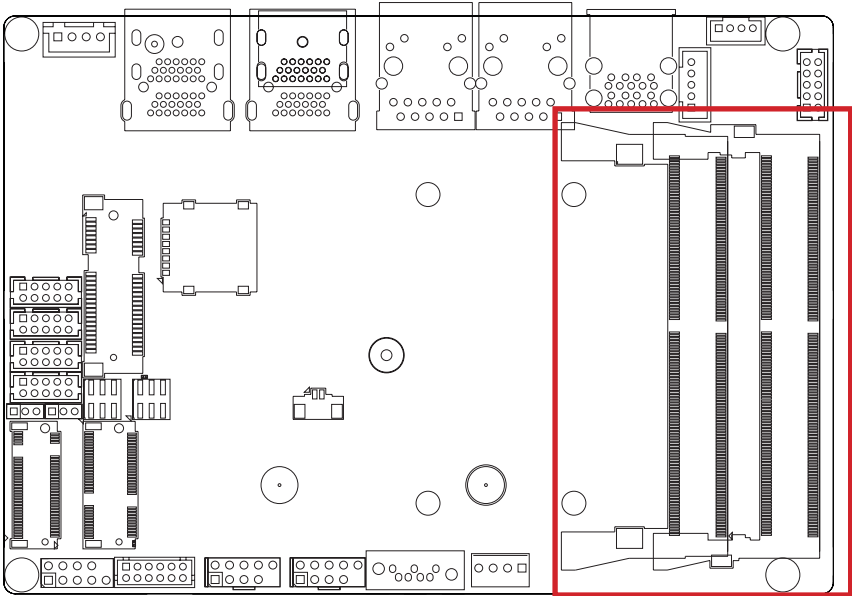

3.2.5 SATAPW (SATA power connector)

5

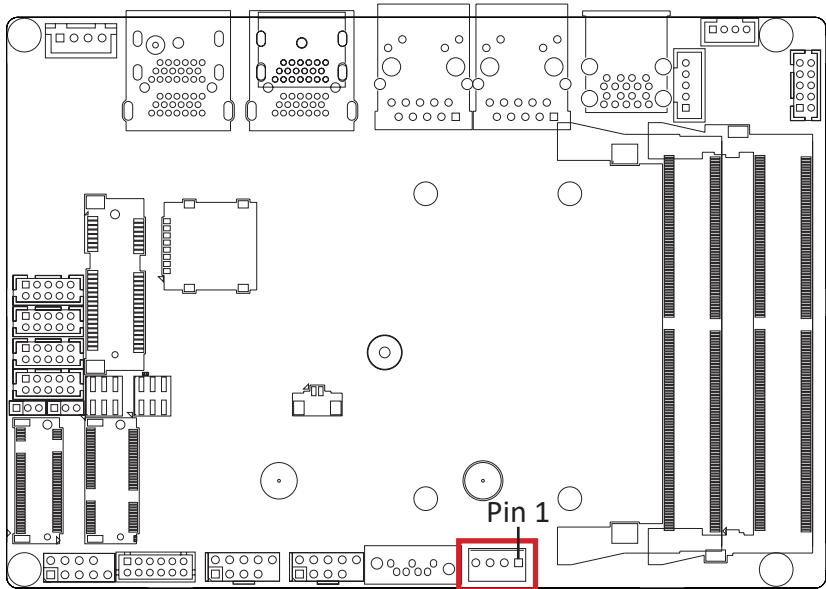

Hard Disk Power Connector



Connector PN

743-81-04TW00

Vendor

PINREX

WF04Q2-3BJQ000

HORNGTONG

Pin No. Definition

1	12V
2	GND
3	GND
4	5V

3.2.6 SATA (SATA 6Gb/s connector)

6

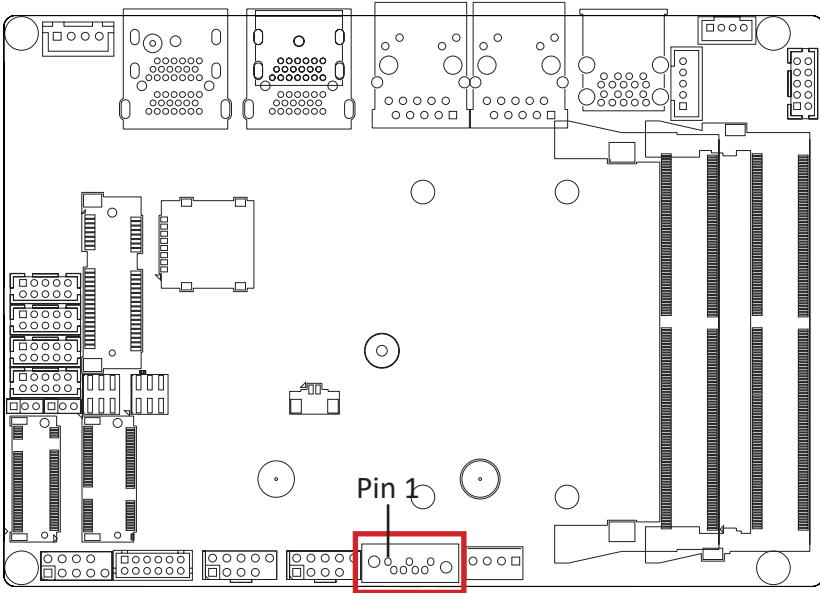

SATA 6Gb/s Connector



Pin No.	Definition
1	GND
2	TXP
3	TXN
4	GND
5	RXN
6	RXP
7	GND

3.2.7 F_USB2_2 (USB 2.0 header)

7

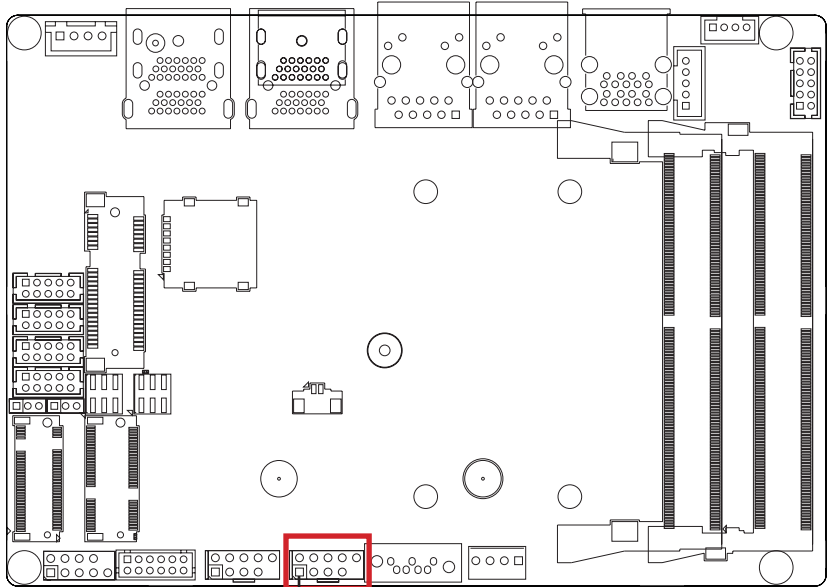

Pin 1

USB 2.0 header



Connector PN

210-92-05G117

Vendor

PINREX

Pin No.	Definition
1	5V
2	5V
3	DX-
4	DY-
5	DX+
6	DY+
7	GND
8	GND
9	No Pin
10	No Connect

3.2.8 F_USB2_1 (USB 2.0 header)

8

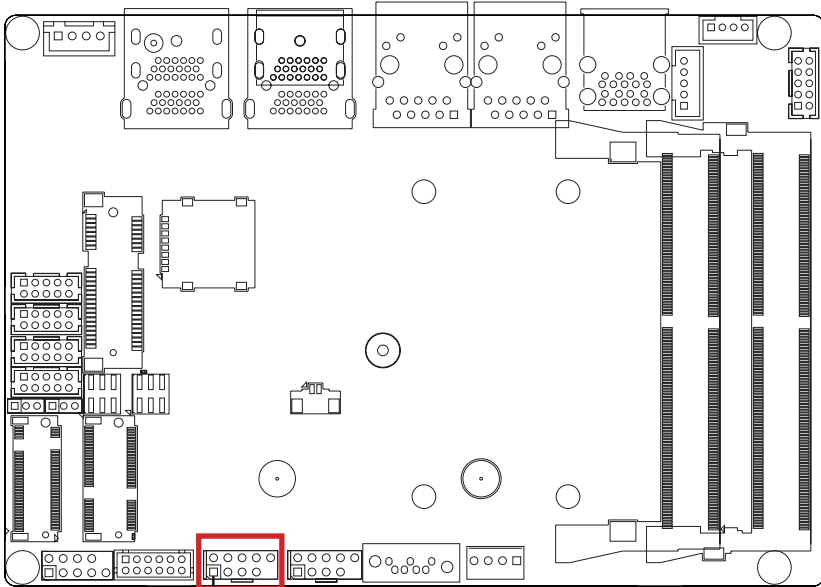

Pin 1

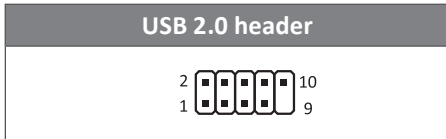

Connector PN	Vendor
210-92-05G117	PINREX

Pin No.	Definition
1	5V
2	5V
3	DX-
4	DY-
5	DX+
6	DY+
7	GND
8	GND
9	No Pin
10	No Connect

3.2.9 GPIO_CNT (General purpose input/output header)

9

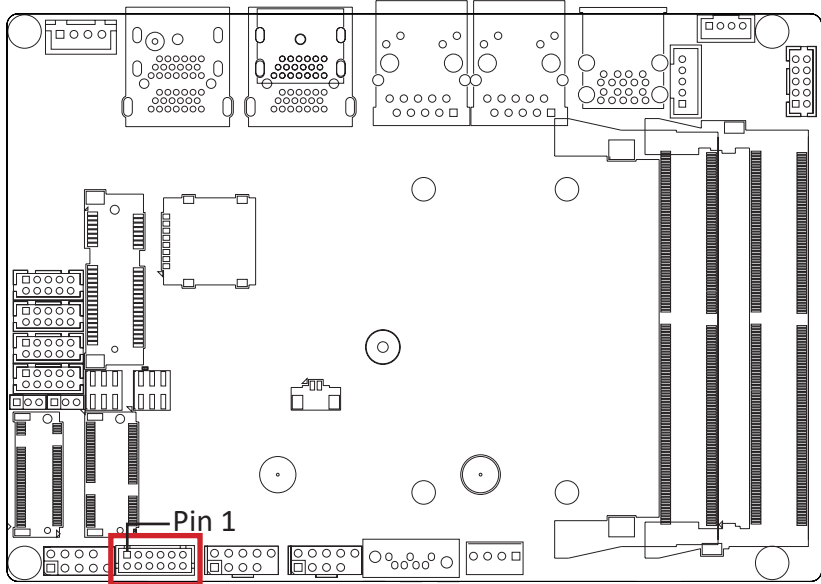

GPIO Connector



Connector PN	Vendor
725-81-12TW00	PINREX
A2004WV-2X06P46	JOINT-TECH

Pin No.	Definition	Pin No.	Definition
1	GPI_0	2	GPO_0
3	GPI_1	4	GPO_1
5	GPI_2	6	GPO_2
7	GPI_3	8	GPO_3
9	SMB_IO_CLK	10	SMB_IO_DATA
11	3.3V	12	GND

3.2.10 SYS_PANEL (Front panel header)

10

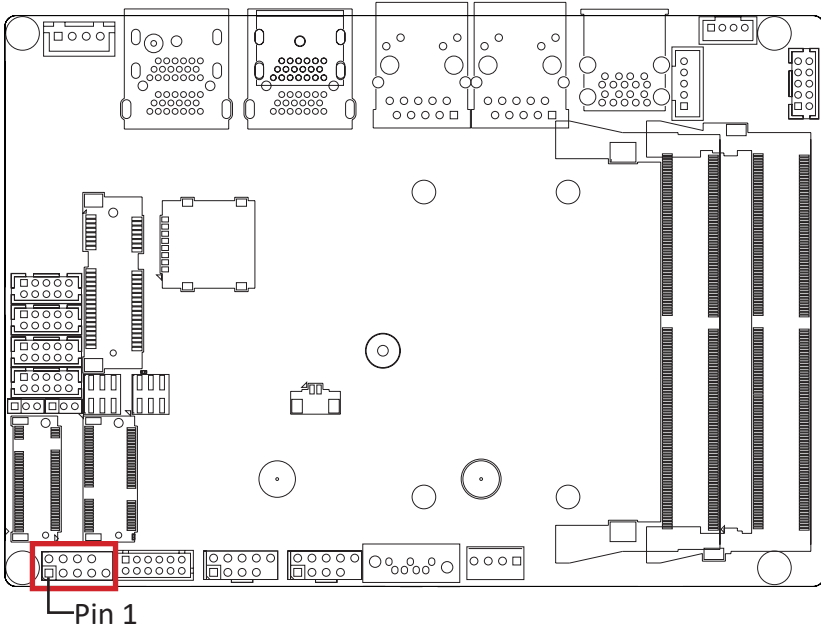

System Panel Header

Connector PN	Vendor
210-92-05G111	PINREX

Pin No.	Definition
1	HDD LED+
2	Power LED+
3	HDD LED-
4	Power LED-
5	GND
6	Power Button+
7	Reset Button
8	Power Button-
9	No Connect
10	No Pin

3.2.11 M2E (M.2 E-key for WiFi NGFF)

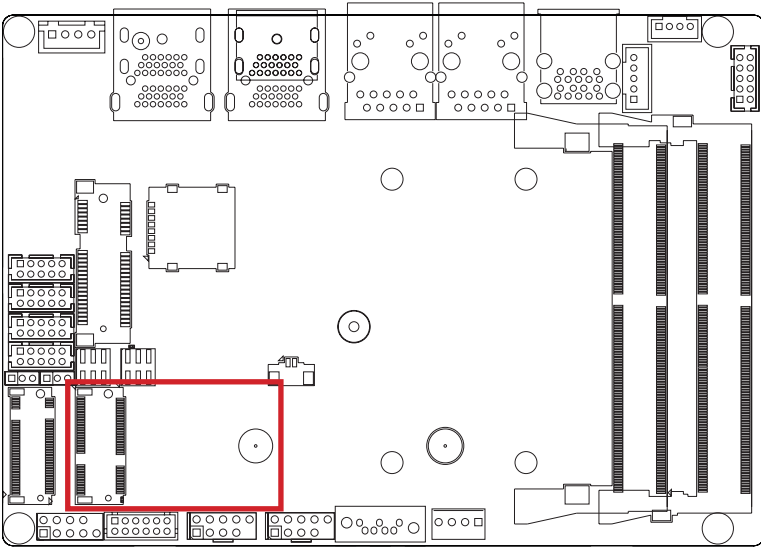
11

3.2.12 M2M (M.2 M key for NVME/SATA)

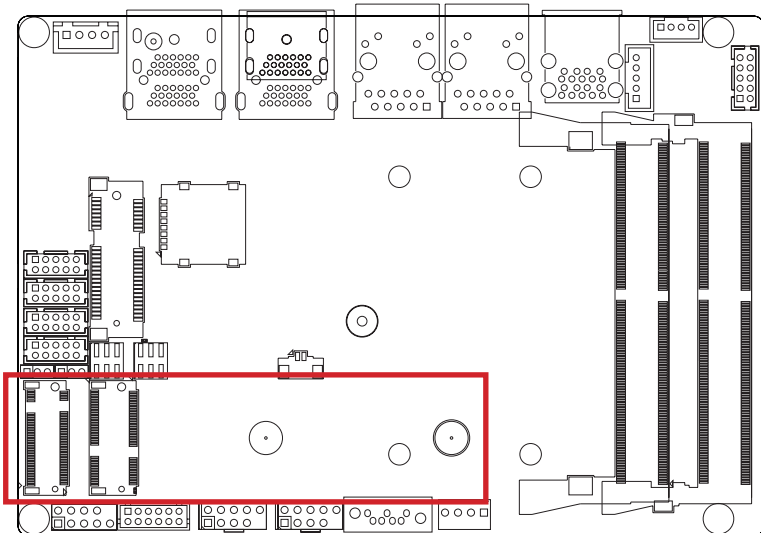
12

3.2.13 AT_CN (AT/ATX mode select jumper)

13

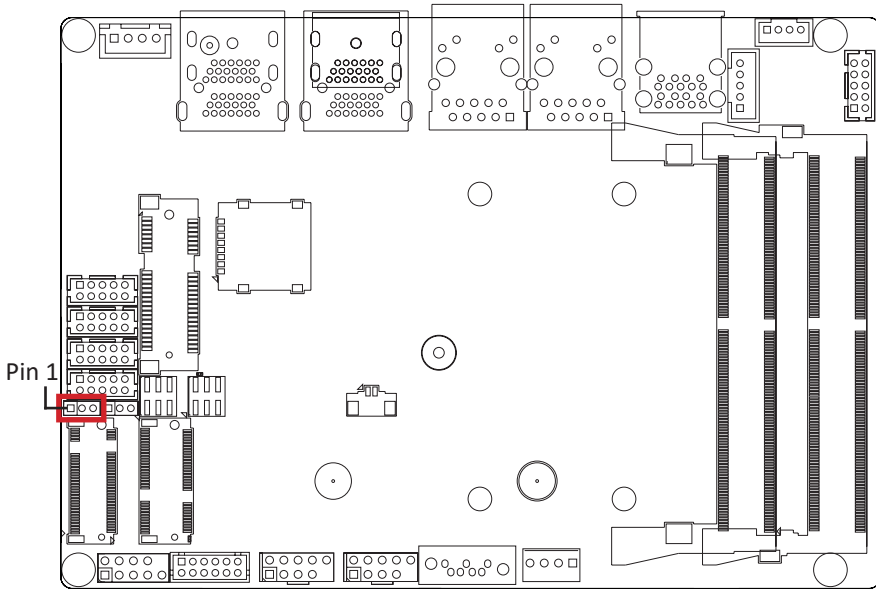

AT/ATX mode select jumper	
	1-2 Close : AT mode.
	2-3 Close : ATX mode. (Default setting)

Pin No.	Definition
1	AT
2	COMM
3	ATX

3.2.14 HDMI/eDP_CN (HDMI/eDP mode select jumper)

14

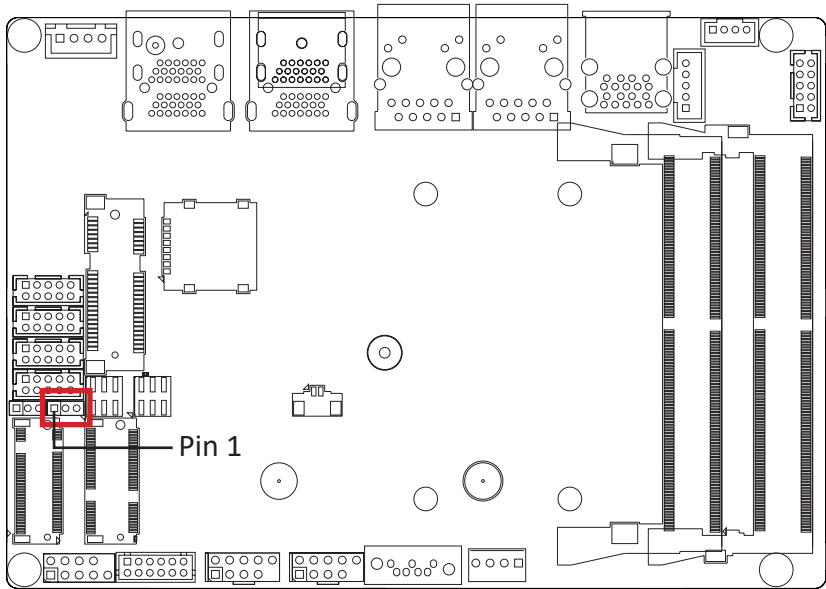

HDMI/eDP mode select jumper

	1-2 Close: HDMI mode. (Default setting, HDMI 4 I/O is Enable)
	2-3 Close: eDP mode. (HDMI 4 I/O Port is Disable)

Pin No.	Definition
1	HDMI
2	COMM
3	eDP

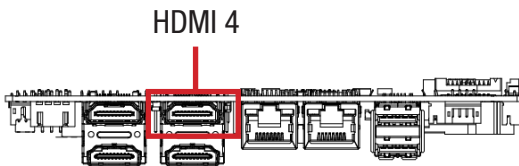

3.2.15 JCOM2 (COM2 RI pin RI/5V/12V Select)

15

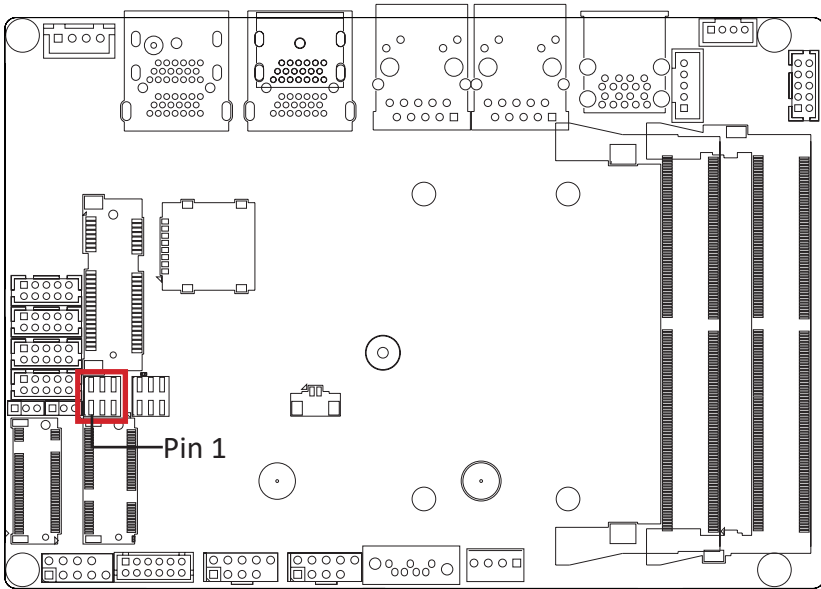

JCOM2 Jumper Select	
	1-2 Close: 5V (Power COM)
	3-4 Close: RI (Stand COM) Default
	5-6 Close: 12V (Power COM)

3.2.16 JCOM1 (COM1 RI pin RI/5V/12V Select)

16

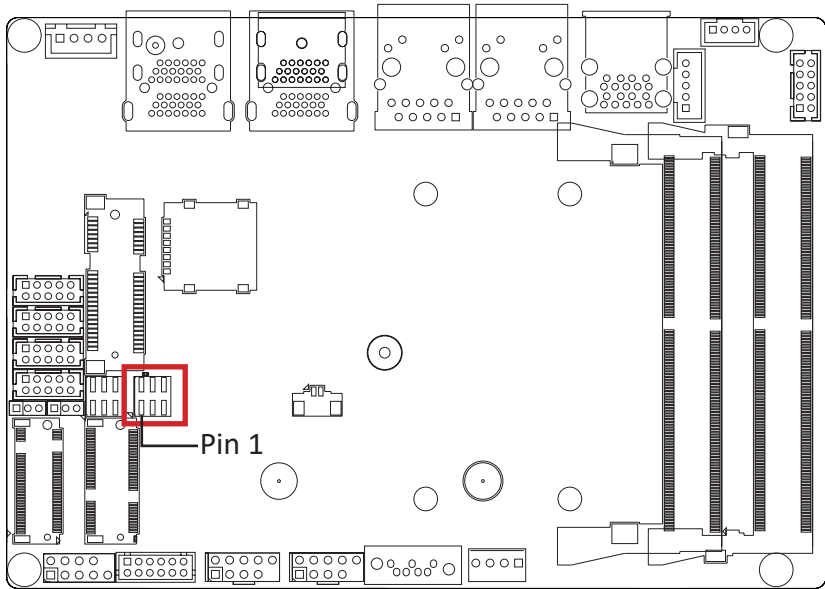

JCOM1 Jumper Select

	1-2 Close: 5V (Power COM)
	3-4 Close: RI (Stand COM) Default
	5-6 Close: 12V (Power COM)

3.2.17 COM1 (Serial port header, RS-232/422/485 & RI/5V/12V)

17

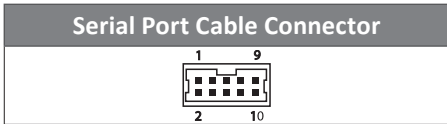
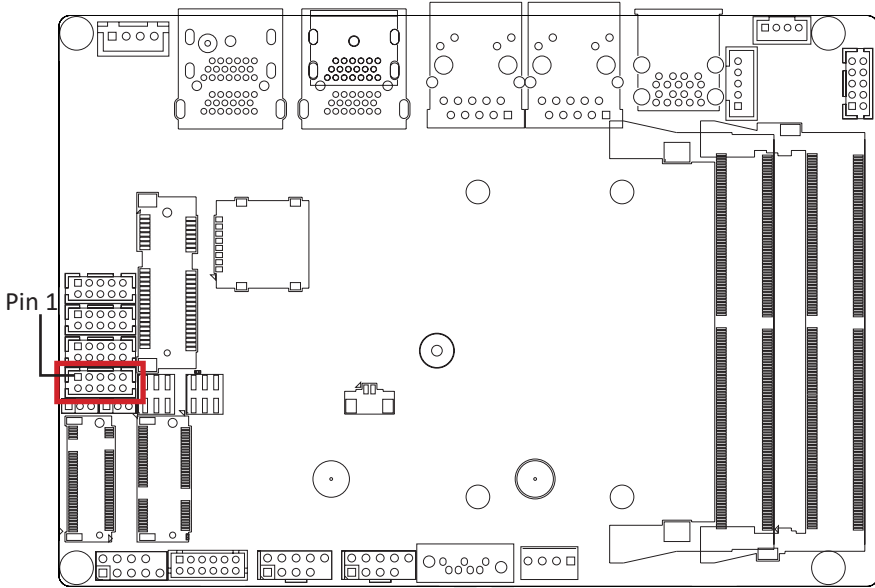

Connector PN	Vendor
725-81-10TW00	PINREX
A2004WV-2X05P46	JOINT-TECH

Pin No.	RS-232	RS-422 Full Duplex	RS-485 Half Duplex
1	RXD	TXD+	D+
2	DCD	TXD-	D-
3	DTR	RXD-	—
4	TXD	RXD+	—
5	DSR	—	—
6	GND	—	—
7	CTS	—	—
8	RTS	—	—
9	No Connect	—	—
10	RI/5V/12V	—	—

3.2.18 COM2 (Serial port header, RS-232/422/485 & RI/5V/12V)

18

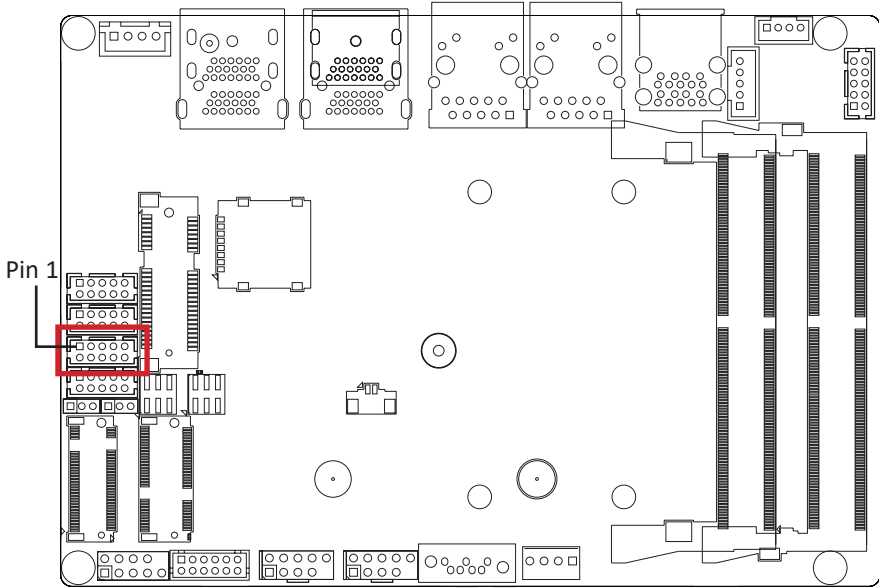

Serial Port Cable Connector

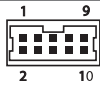

Connector PN

725-81-10TW00

A2004WV-2X05P46

Vendor

PINREX

JOINT-TECH

Pin No.	RS-232	RS-422 Full Duplex	RS-485 Half Duplex
1	RXD	TXD+	D+
2	DCD	TXD-	D-
3	DTR	RXD-	—
4	TXD	RXD+	—
5	DSR	—	—
6	GND	—	—
7	CTS	—	—
8	RTS	—	—
9	No Connect	—	—
10	RI/5V/12V	—	—

3.2.19 COM3 (Serial port header, RS-232)

19

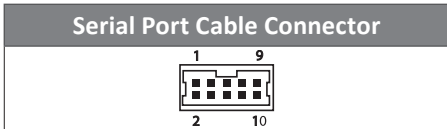
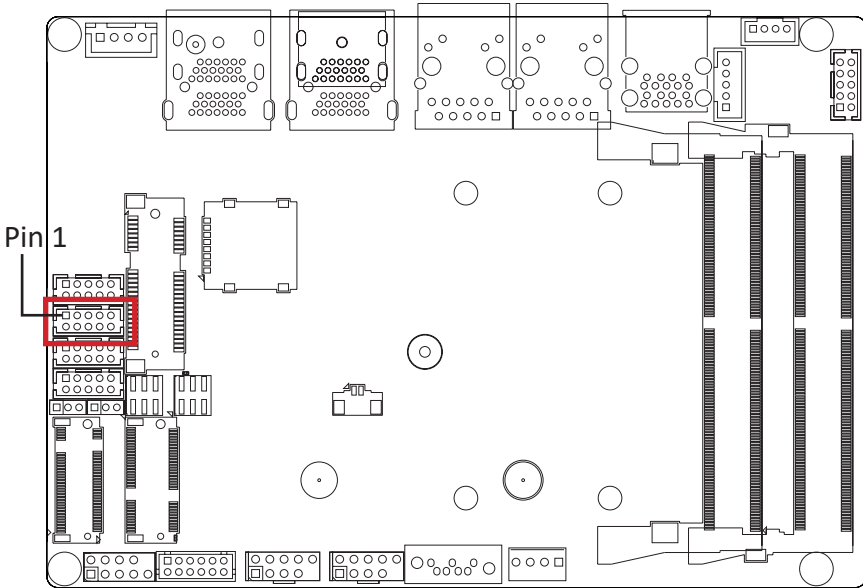

Connector PN	Vendor
725-81-10TW00	PINREX
A2004WV-2X05P46	JOINT-TECH

Pin No.	Definition
1	RXD
2	DCD
3	DTR
4	TXD
5	DSR
6	GND
7	CTS
8	RTS
9	No Connect
10	RI/5V/12V

3.2.20 COM4 (Serial port header, RS-232)

20

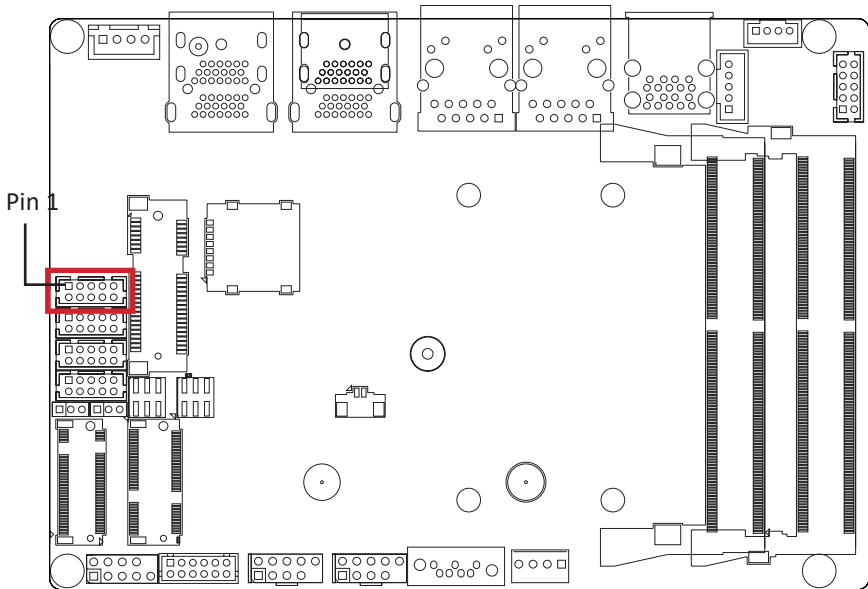

Serial Port Cable Connector

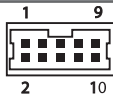

Connector PN

725-81-10TW00

A2004WV-2X05P46

Vendor

PINREX

JOINT-TECH

Pin No.	Definition
1	RXD
2	DCD
3	DTR
4	TXD
5	DSR
6	GND
7	CTS
8	RTS
9	No Connect
10	RI/5V/12V

3.2.21 MPCIE (Mini PCIE for 3G/4G module)

21

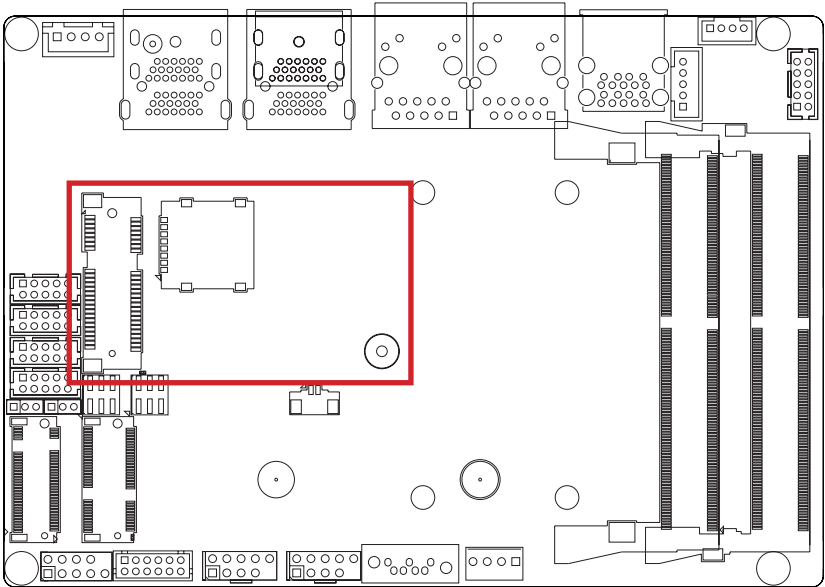

3.2.22 DC IN (DC IN 1 x 4 pin power connector)

22

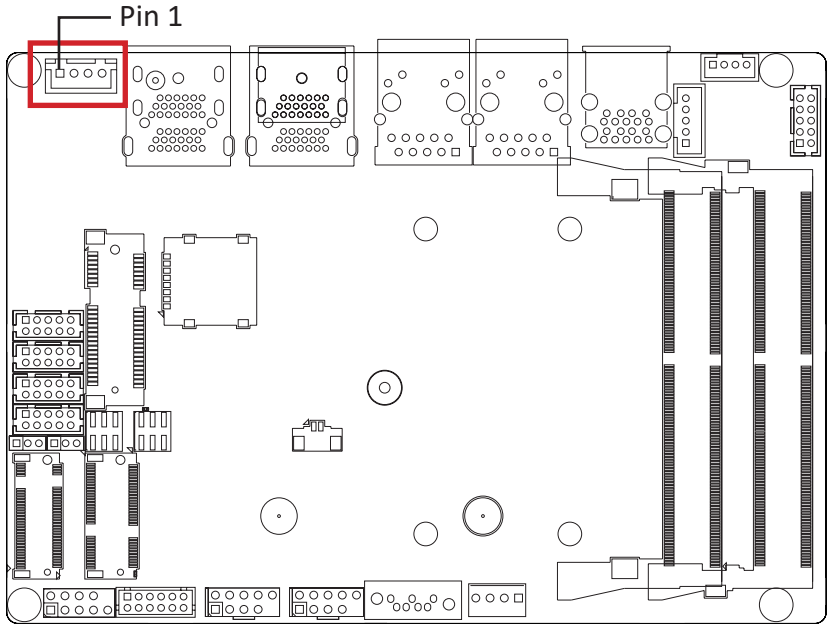

DC IN power connector

DC_IN



Connector PN

753-81-04TW00

Vendor

PINREX

Pin No.

Definition

1	GND
2	DCIN
3	DCIN
4	GND

3.2.23 Battery (Battery Connector)

23

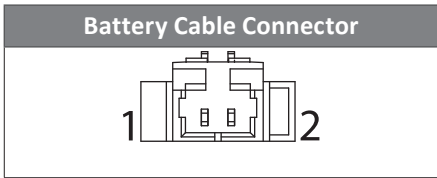
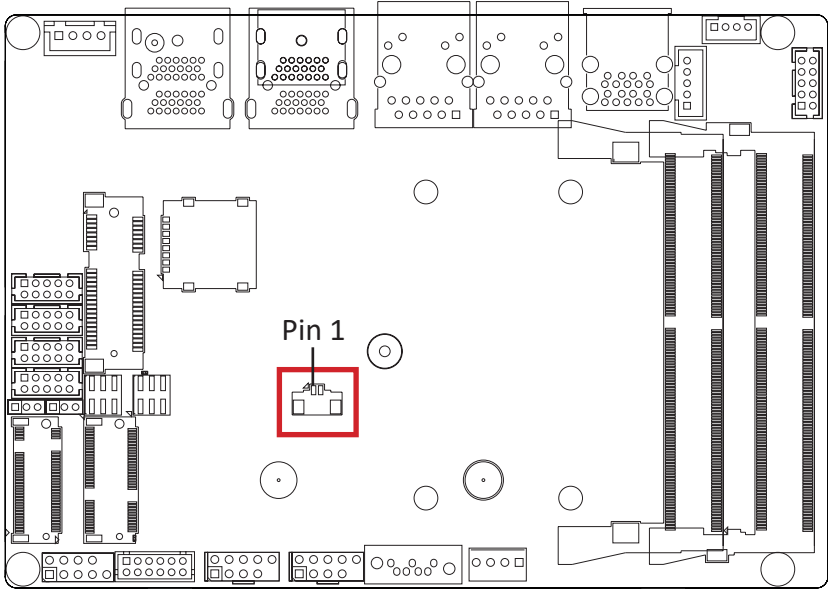

Pin No.	Definition
1	3.3V RTC
2	GND

3.2.24 EDP (eDP Connector)

24

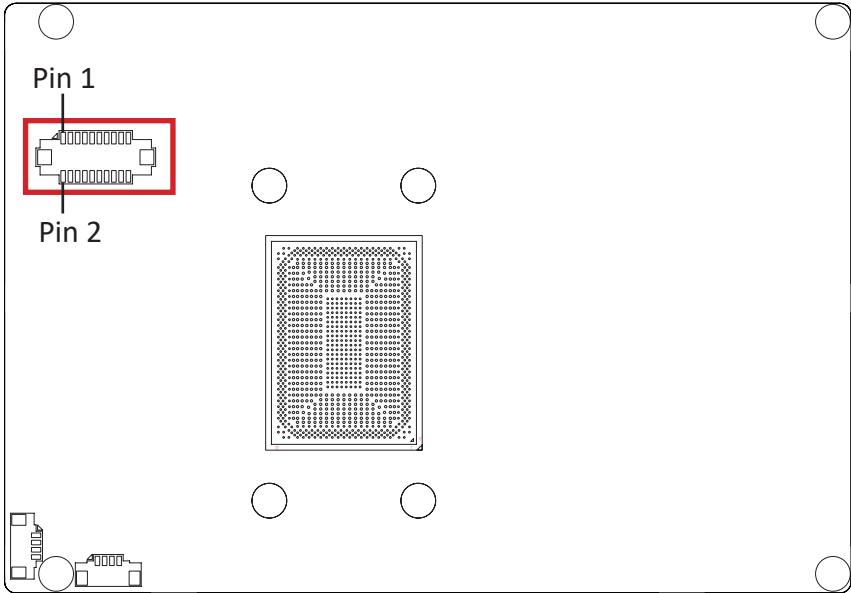

Pin No.	Definition	Pin No.	Definition
1	GND	2	GND
3	EDP_TXN0	4	EDP_TXN3
5	EDP_TXP0	6	EDP_TXP3
7	GND	8	eDP_DET#
9	EDP_TXN1	10	GND
11	EDP_TXP1	12	EDP_AUXN
13	GND	14	EDP_AUXP
15	EDP_TXN2	16	GND
17	EDP_TXP2	18	EDP_HPDP
19	5V	20	3.3V

Connector PN	Vendor
50286-02071-001	ACES
A1252WV-SF-2X10PN6BG1G00L	JOINT-TECH

3.2.25 CPU_FAN (CPU FAN Connector)

25

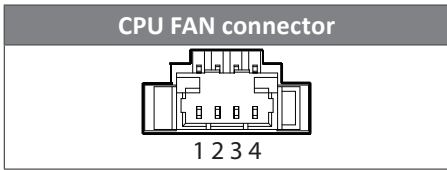
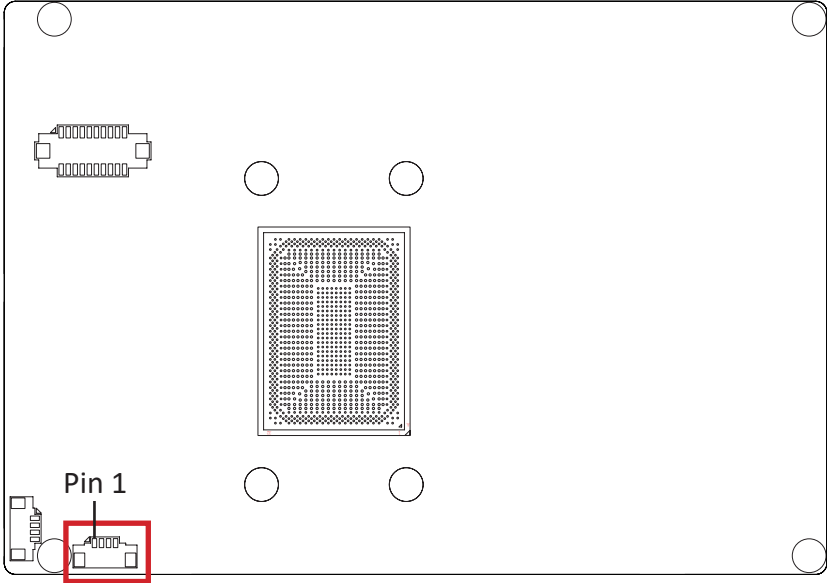

Connector PN	Vendor
85205-0470N	ACES
A1250WV-S-04PC	JOINT-TECH

Pin No.	Definition
1	GND
2	12V
3	FANTECH
4	PWM

3.2.26 SYS_FAN (System FAN Connector)

26

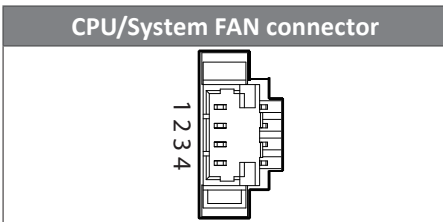
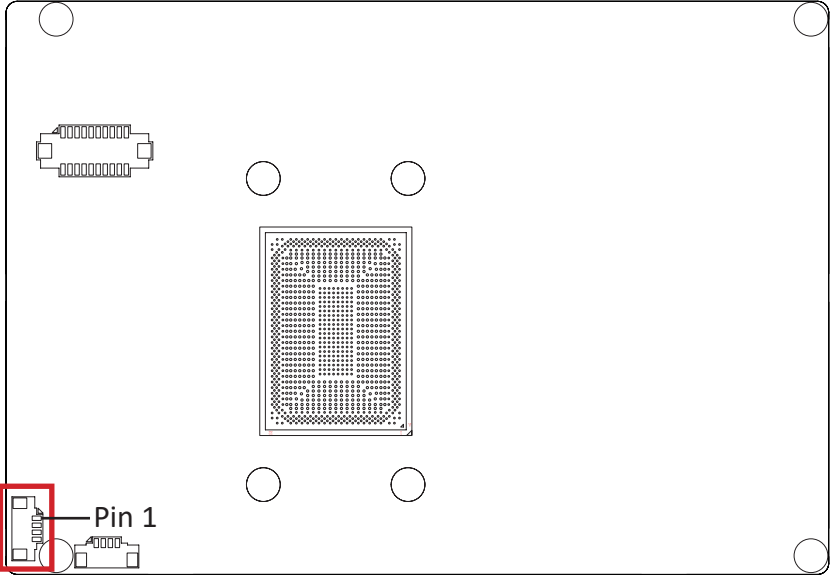

Connector PN	Vendor
85205-0470N	ACES
A1250WV-S-04PC	JOINT-TECH

Pin No.	Definition
1	GND
2	12V
3	FANTECH
4	PWM

3.2.27 IO Connector Information

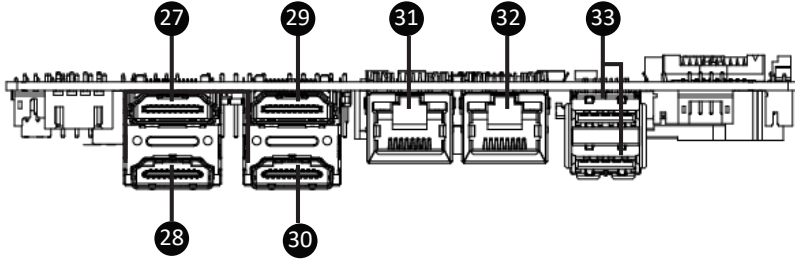

	Code	Description
27	HDMI1_2	HDMI 2 connector
28		HDMI 1 connector
29	HDMI3_4	HDMI 4 connector (*The HDMI 4's Function is Disabled, during eDP Function Enabled)
30		HDMI 3 connector
31	LAN2	LAN connectors
32	LAN1	LAN connectors
33	USB3	USB 3.2 Gen 1