

# QBiX-Pro-KBLB7200H-A2 (QP-7200A-SI)

---

QBiX-Pro Industrial Embedded System  
Quick Start Guide

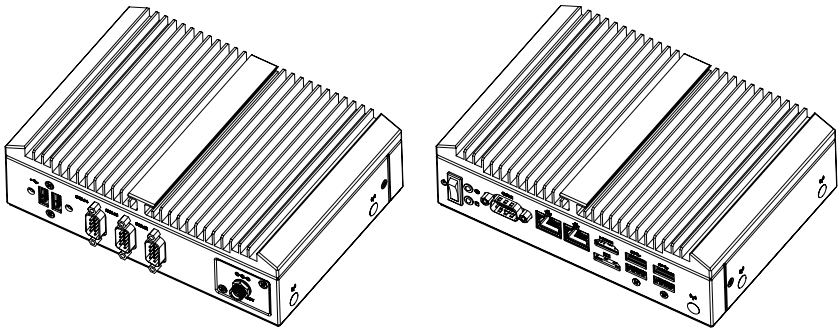

## Copyright Notice

---

This document is copyrighted, 2019. All rights are reserved. The original manufacturer reserves the right to make improvements to the products described in this manual at any time without notice.

No part of this manual may be reproduced, copied, translated, or transmitted in any form or by any means without the prior written permission of the original manufacturer. Information provided in this manual is intended to be accurate and reliable. However, the original manufacturer assumes no responsibility for its use, or for any infringements upon the rights of third parties that may result from its use.

The material in this document is for product information only and is subject to change without notice. While reasonable efforts have been made in the preparation of this document to assure its accuracy, GIGAIPC assumes no liabilities resulting from errors or omissions in this document, or from the use of the information contained herein.

GIGAIPC reserves the right to make changes in the product design without notice to its users.

## Acknowledgement

---

All other products' name or trademarks are properties of their respective owners.

- AMD is trademark of Advanced Micro Devices.
- Microsoft Windows is a registered trademark of Microsoft Corp.
- Intel, Pentium, Celeron, and Xeon are registered trademarks of Intel Corporation
- Core, Atom are trademarks of Intel Corporation
- ITE is a trademark of Integrated Technology Express, Inc.
- IBM, PC/AT, PS/2, and VGA are trademarks of International Business Machines Corporation.

All other product names or trademarks are properties of their respective owners.

## Packing List

---

Before setting up your product, please make sure the following items have been shipped:

Item	Quantity
Screw I Head For 2.5" HDD M3x8L (25KSG-130081-K1R)	4
Thermal Pad for 2.5" HDD (25ST3-200052-T5R)	2
Thermal Pad for WiFi module (25ST3-200053-T5R)	1
Thermal Pad for Memory (25ST3-200051-T5R)	1
SATA Cable (25CF4-070020-S9R)	1
Power Cord (May vary based on local distribution)	1
PSU ADP 19V 65W 100-240VAC (25EP2-10065L-F3S)	1
Exsiccator (10g)	1

If any of these items are missing or damaged, please contact your distributor or sales representative immediately.

## About this Document

---

This User's Manual contains all the essential information, such as detailed descriptions and explanations on the product's hardware and software features (if any), its specifications, dimensions, jumper/connector settings/definitions, and driver installation instructions (if any), to facilitate users in setting up their product.

Users may refer to the [GIGAIPC.com](http://GIGAIPC.com) for the latest version of this document.

## Safety Precautions

---

Please read the following safety instructions carefully. It is advised that you keep this manual for future references

1. All cautions and warnings on the device should be noted.
2. Make sure the power source matches the power rating of the device.
3. Position the power cord so that people cannot step on it. Do not place anything over the power cord.
4. Always completely disconnect the power before working on the system's hardware.
5. No connections should be made when the system is powered as a sudden rush of power may damage sensitive electronic components.
6. If the device is not to be used for a long time, disconnect it from the power supply to avoid damage by transient over-voltage.
7. Always disconnect this device from any AC supply before cleaning.
8. While cleaning, use a damp cloth instead of liquid or spray detergents.
9. Make sure the device is installed near a power outlet and is easily accessible.
10. Keep this device away from humidity.
11. Place the device on a solid surface during installation to prevent falls
12. Do not cover the openings on the device to ensure optimal heat dissipation.

13. Watch out for high temperatures when the system is running.
14. Do not touch the heat sink or heat spreader when the system is running
15. Never pour any liquid into the openings. This could cause fire or electric shock.
16. As most electronic components are sensitive to static electrical charge, be sure to ground yourself to prevent static charge when installing the internal components. Use a grounding wrist strap and contain all electronic components in any static-shielded containers.
17. If any of the following situations arises, please the contact our service personnel:
  - i. Damaged power cord or plug
  - ii. Liquid intrusion to the device
  - iii. Exposure to moisture
  - iv. Device is not working as expected or in a manner as described in this manual
  - v. The device is dropped or damaged
  - vi. Any obvious signs of damage displayed on the device
- 18. DO NOT LEAVE THIS DEVICE IN AN UNCONTROLLED ENVIRONMENT WITH TEMPERATURES BEYOND THE DEVICE'S PERMITTED STORAGE TEMPERATURES (SEE CHAPTER 1) TO PREVENT DAMAGE.**

## FCC Statement

---

### **Warning!**



This device complies with Part 15 FCC Rules. Operation is subject to the following two conditions: (1) this device may not cause harmful interference, and (2) this device must accept any interference received including interference that may cause undesired operation.

### **Caution:**

*There is a danger of explosion if the battery is incorrectly replaced. Replace only with the same or equivalent type recommended by the manufacturer. Dispose of used batteries according to the manufacturer's instructions and your local government's recycling or disposal directives.*

### **Attention:**

*Il y a un risque d'explosion si la batterie est remplacée de façon incorrecte. Ne la remplacer qu'avec le même modèle ou équivalent recommandé par le constructeur. Recycler les batteries usées en accord avec les instructions du fabricant et les directives gouvernementales de recyclage.*



## Table Contents

<b>QBiX-Pro Industrial Embedded System</b>	<b>1</b>
<b>Quick Start Guide</b>	<b>1</b>
Copyright Notice .....	2
Acknowledgement .....	3
Packing List.....	4
About this Document.....	5
Safety Precautions .....	6
FCC Statement.....	8
<b>Chapter 1 - Product Specifications</b>	<b>11</b>
1.1 Specifications .....	13
<b>Chapter 2 – QBiX-Pro-KBLB7200H-A2 (QP-7200A-SI) Industrial Embedded System Kit</b>	<b>15</b>
2.1 Dimension .....	16
2.2 Getting Familiar with Your Unit.....	17
2.3 A) Wireless Module: How to safely install the Module (Wireless Module inclusion may vary based on local distribution) .....	19
2.4 B) Memory Installation: DDR4 SO-DIMM .....	20
2.5 Antenna Installation (Antenna inclusion may vary based on local distribution) .....	21
2.6 DB9 COM Pin Define .....	22
2.7 Support .....	23

2.8	Safety and Regulatory Information.....	24
<b>Chapter 3 – Hardware Information</b>		<b>25</b>
3.1	Jumpers and Connectors .....	26
3.2.1	CPU FAN (CPU FAN connector) .....	29
3.2.2	System FAN (System FAN connector) .....	30
3.2.3	COM2, COM3, COM4 (Serial port header) .....	31
3.2.4	FUSB (USB 2.0 header) .....	32
3.2.5	SATAIII_0, SATAIII_1 (SATA 6GB/S Connector) .....	33
3.2.6	GPIO_CNT (General Purpose input/output header ) ....	34
3.2.7	SATAPW1, SATAPW2 (SATA 6Gb/s power connector) ...	35
3.2.8	AT_CN (AT/ATX power mode select jumper) .....	36
3.2.9	DC_IN (DC IN 1x4-pin power connector ).....	37
3.2.10	SPK_OUT (Speaker out connector) .....	38
3.2.11	FP_Audio (Front Audio connector) .....	39
3.2.12	BKL_CN (Back light brightness control connector) .....	40
3.2.13	SYS_PANEL (Front panel header) .....	41
3.2.14	LVDS (LVDS connector).....	42
3.2.15	LSW (LVDS resolution jumper) .....	43
3.2.16	BATTERY (Battery cable connector).....	44
3.2.17	JCOM1 (COM1 RI# pin RI#/5V/12V Select).....	45

# Chapter 1

## Chapter 1 - Product Specifications

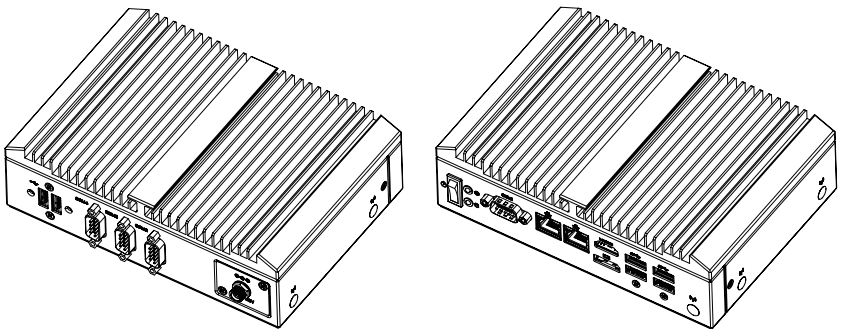

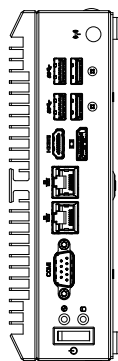
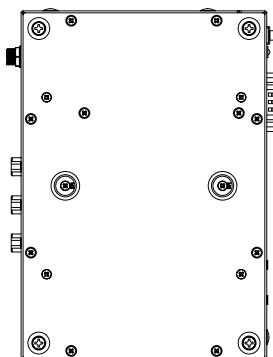
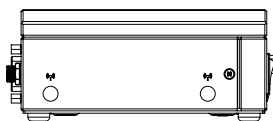
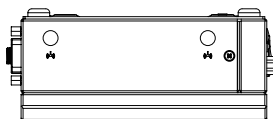
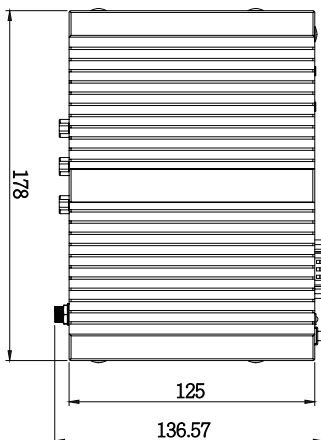
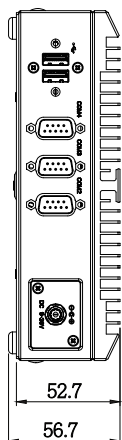

## 1.1 Specifications

System	QBiX-Pro-KBLB7200H-A2 (QP-7200A-SI)
Dimension	System Size : 178W x 125D x 52.7H (mm)
CPU	Intel® Core™ i5-7200U Processor 14nm, 2 cores, 4 threads, up to 3.1 GHz TDP 15W 3 MB SmartCache
Chipset	SoC
Memory	2 x DDR4 SO-DIMM sockets, Max. Capacity 32 GB Support Dual channel DDR4 2133 MHz memory module
Ethernet	2 x GbE LAN Ports (Intel® I219V and Intel® I211AT)
Graphic support	Integrated Graphics Processor - Intel® HD Graphics 620 : 1 x HDMI 2.0 port, supporting a maximum resolution of 4096x2160 @60Hz 1 x DP port, supporting a maximum resolution of 4096x2160 @60Hz  (2 independent display outputs)
Audio	Realtek® Audio Codec
Storage	1 x 2.5" HDD/SSD (SATA 6Gb/s)
Expansion Slots	1 x 2280 M.2 M-Key (PCIe x4, SATA 6Gb/s) 1 x 2230 M.2 E-Key (WiFi/BT) 1 x Full-size Mini PCIe with SIM slot (PCIe x1 + USB2.0) -- support 3G/4G module
Front I/O	2 x RJ45 LAN Ports 4 x USB 3.2 Gen 1 1 x HDMI 1 x Display Port 1 x Power switch 1 x Power & HDD LED 1 x COM Port (RS-232/422/485 & RI/5V/12V)
Rear I/O	2 x USB 2.0 3 x COM Ports (RS-232) 1 x Screw Type DC Jack
Side I/O	2 x External Antenna Holes (Optional)
TPM	—

System	QBiX-Pro-KBLB7200H-A2 (QP-7200A-SI)
Power	+9~36VDC (Adapter 19V/65W)
Operation Temperature	Operating temperature: 0°C to 40°C (0~50°C 90W adapter) Operating humidity: 0-90% (non-condensing) Non-operating temperature: -20°C to 70°C Non-operating humidity: 0%-95% (non-condensing) Use wide temperature range memory and storage
Vibration During Operation	Operation: IEC 60068-2-64, 5 Grms, random, 5 ~ 500 Hz, 1 hr / Per Axis, with SSD/M.2 2280 Non-operation: IEC 60068-2-6, 2 G, Sine, 10 ~ 500 Hz, 1 Oct/ min, 1 hr / Per Axis
Shock During Operation	Operation: IEC 60068-2-27, 50 G, half sine, 11 ms duration, With SSD
Packaging Content	Carton size: 505 x 333 x 231 (mm) Packing Capacity: 5pcs  Including: Screw I Head for 2.5" HDD M3x8L x 4 (P/N: 25KSG-130081-K1R) Thermal Pad for 2.5" HDD x 2 (P/N: 25ST3-200052-T5R) Thermal Pad for WiFi module x 1 (P/N: 25ST3-200053-T5R) Thermal Pad for Memory x 1 (P/N: 25ST3-200051-T5R) SATA Cable x 1 (P/N: 25CF4-070020-S9R) Power Cord : Optional (By region) PSU ADP 19V 65W 100-240VAC x 1 (P/N: 25EP2-10065L-F3S)
Order Information	System : 6BQP7200AMR-SI (Box packing)

## Chapter 2

---

### Chapter 2 – QBiX-Pro-KBLB7200H-A2 (QP-7200A-SI) Industrial Embedded System Kit

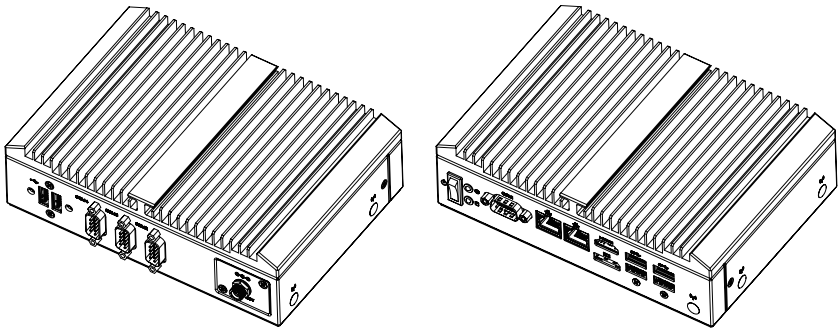

## 2.1 Dimension

---

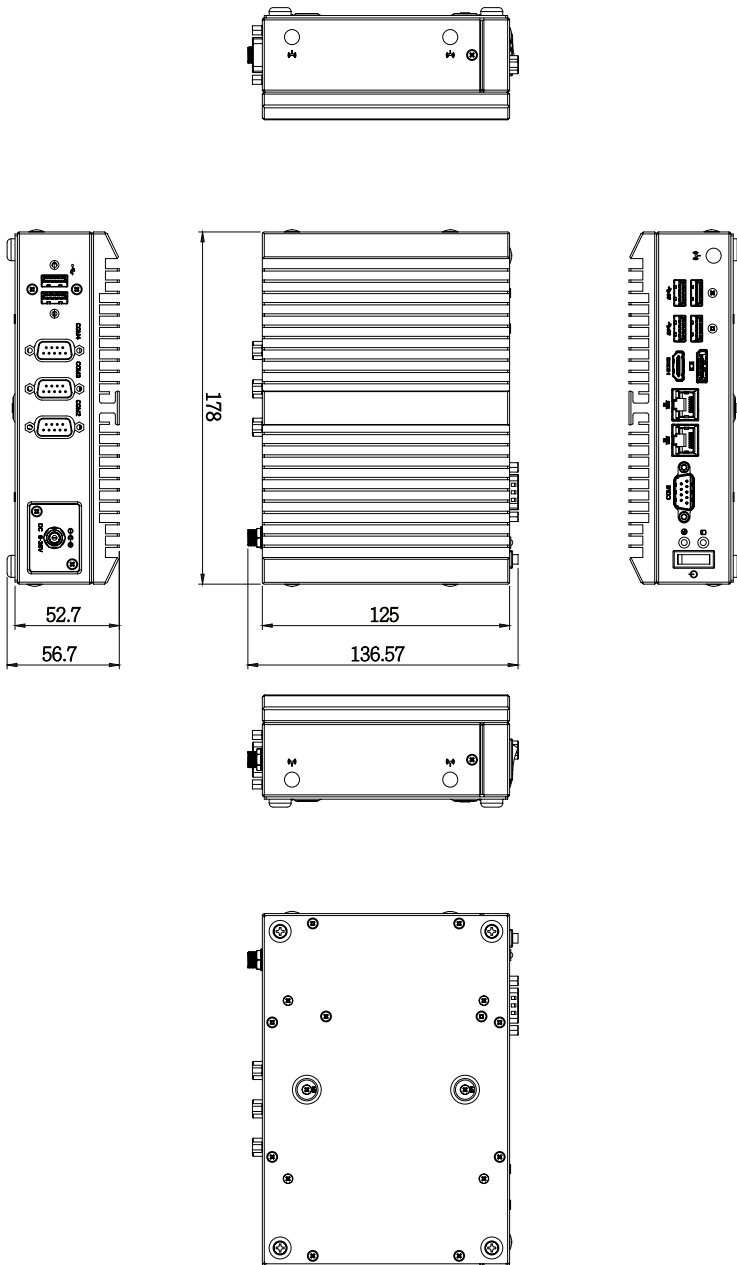



## 2.2 Getting Familiar with Your Unit

### [Front I/O Side]

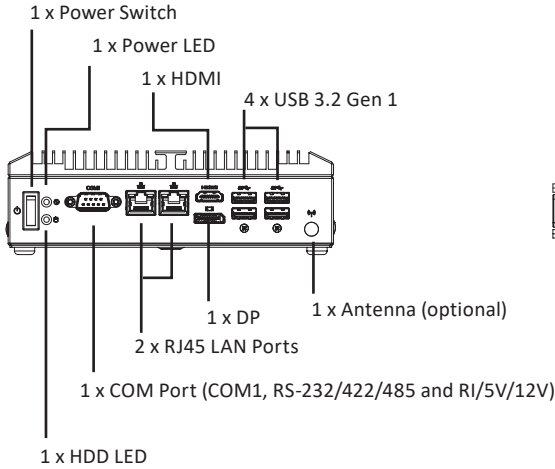

### [Left Side]

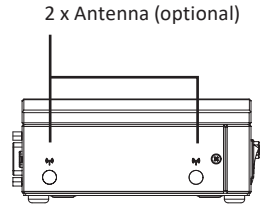

### [Rear I/O Side]

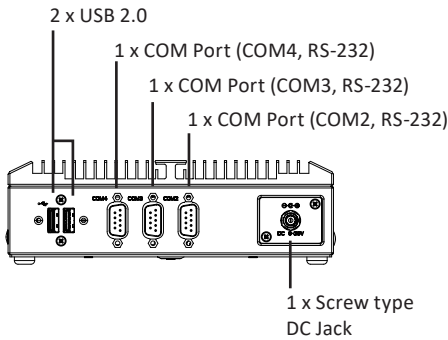

### [Right Side]

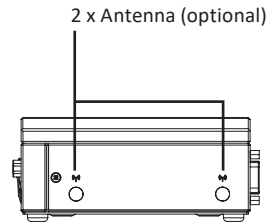

## [Install]

- \* Before opening the case, make sure to unplug the power cord.
- \* Before Connecting the power, make sure to fasten the case securely.

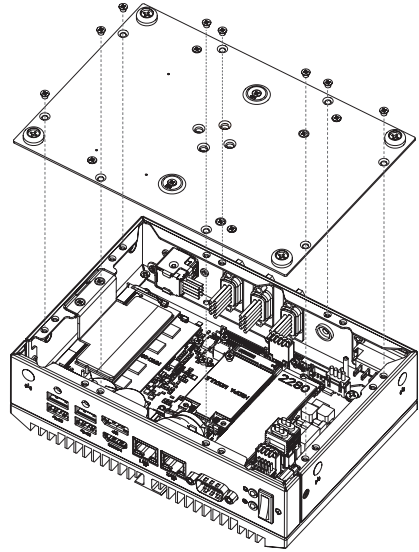
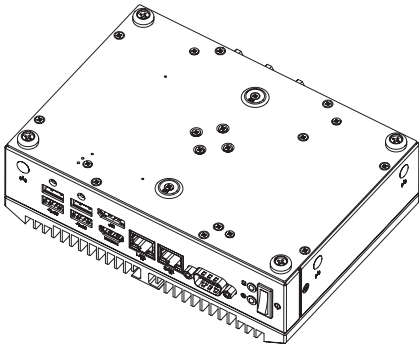

## [Bottom PCB Side]

Information	
A	2 x DDR4 SO-DIMM sockets, Max. Capacity 32 GB, Support Dual Channel DDR4 2133 MHz
B	1 x Full-size miniPCIe with SIM slot

Information	
C	1 x 2230 M.2 E-Key
D	1 x 2280 M.2 M-Key (PCIe x4, SATA 6Gb/s)
E	2.5" Hard drive/ SSD

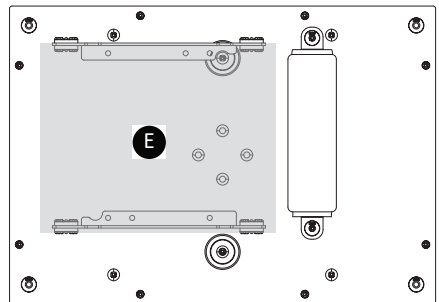
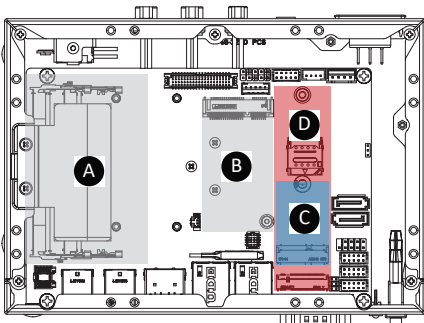

## 2.3 A) Wireless Module: How to safely install the Module (Wireless Module inclusion may vary based on local distribution)

1

Carefully insert the wireless module into the M.2 slot

小心地將無線模組安裝於M.2插槽中。

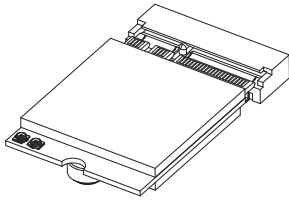

2

Lock the screw in the middle.

鎖入固定於無線模組中央頂端的螺絲。

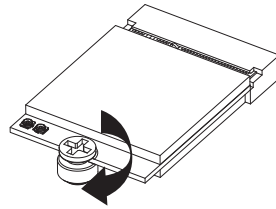

3

Install the antenna on the left side of the connection wireless module down.

向下安裝連結於無線模組左側頂端天線。

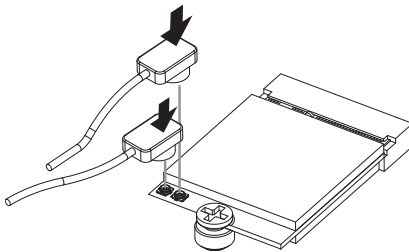

## 2.4 B) Memory Installation: DDR4 SO-DIMM

---

1

Carefully insert SO-DIMM memory modules.

小心地由下至上將 SO-DIMM 記憶體安裝於記憶體插槽。

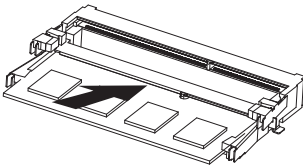

2

Push down until the modules click into place.

當記憶體固定於插槽後，再輕輕下壓至定點。

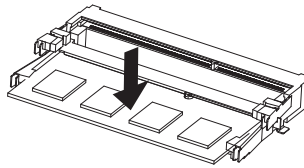

3

Carefully insert SO-DIMM memory modules.

安裝下層記憶體後，重覆前述動作安裝上層記憶體。

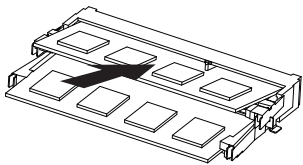

4

Push down until the modules click into place.

當記憶體固定於插槽後，再輕輕下壓至定點。

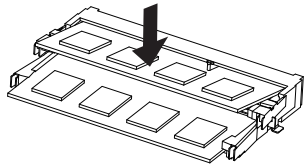

## 2.5 Antenna Installation (Antenna inclusion may vary based on local distribution)

①

Carefully insert the antennas into the connectors.  
小心地將天線插入天線插孔中。

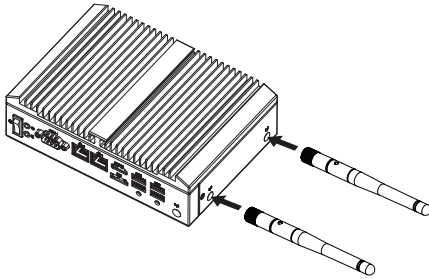

②

Turn the antennas clockwise until they are completely secure on the connectors.  
握住天線接頭底端，按順時針方向將天線旋入插孔中牢牢固定。

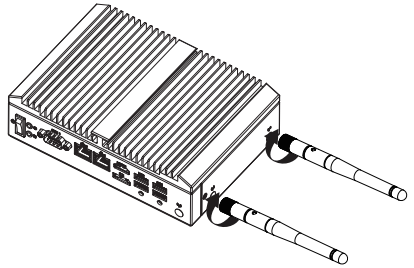

③

Flip up the antenna heads so that they are perpendicular to the machine.  
栓緊後請將天線拉起朝上呈垂直狀。

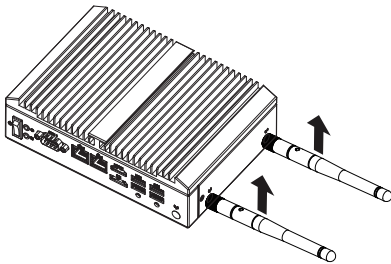

## 2.6 DB9 COM Pin Define

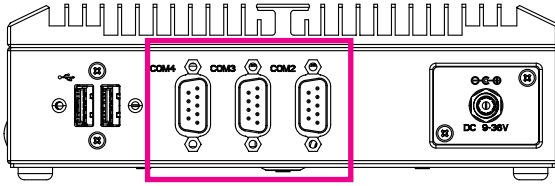

### DB9 COM

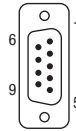

25CF8-210620 S9R

Pin No.	Pin Define
1	DCD
2	RXD
3	TXD
4	DTR
5	GND
6	DSR
7	RTS
8	CTS
9	RI

## 2.7 Support

---

- For a list of tested memory, M.2, 2.5" SSD, wireless adapters and OS supported, go to: <http://www.gigaipc.com>
- To download the latest drivers and BIOS updates, go to: <http://www.gigaipc.com>
- For product support, go to: <http://www.gigaipc.com>

## 2.8 Safety and Regulatory Information

---

Risk of explosion if the battery is replaced with an incorrect type. Batteries should be recycled where possible.

Disposal of used Batteries must be in accordance with local environmental regulations.

Failure to use the included Power Adapter may violate regulatory compliance and may expose the user to safety hazards.

**HDMI**™  
HIGH DEFINITION MULTIMEDIA INTERFACE



At the end of its serviceable life, this product should not be treated as household or general waste. It should be handed over to the applicable collection point for the recycling of electrical and electronic equipment, or returned to the supplier for disposal.



# Chapter 3

---

## Chapter 3 – Hardware Information

# 3.1 Jumpers and Connectors

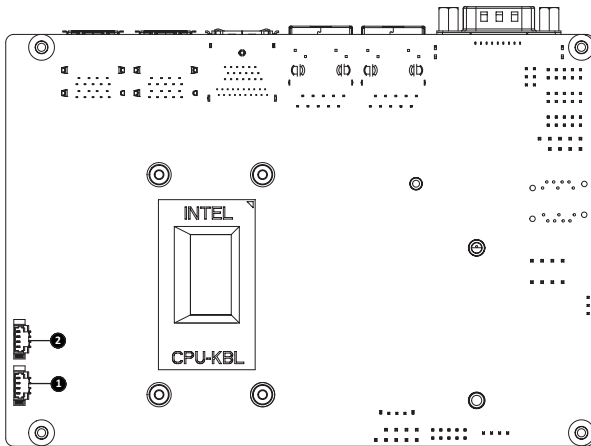
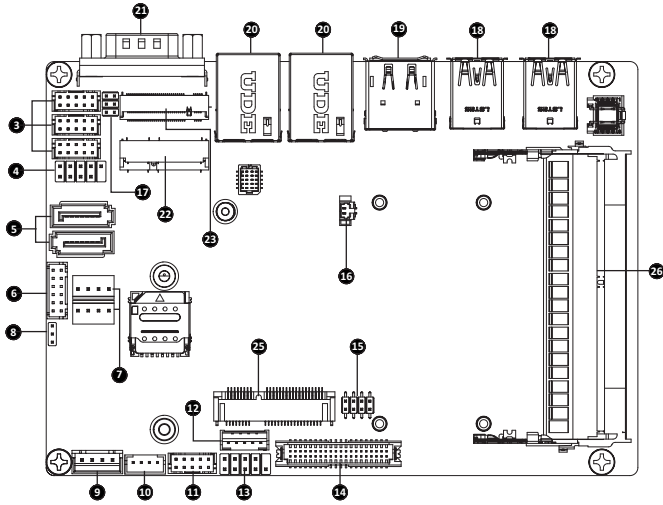

No	Code	Description
1	CPU FAN	CPU FAN connector
2	SYS FAN	System FAN connector
3	COM2 COM3 COM4	Serial port header
4	FUSB	USB 2.0 header
5	SATAIII1 SATAIII0	SATA 6GB/S Connector
6	GPIO_CNT	General purpose input/output header
7	SATAPW1 SATAPW2	SATA 6Gb/s power connector
8	AT_CN	AT/ATX power mode select jumper
9	DC_IN	DC IN 1x4pin power connector
10	SPK_OUT	Speaker out connector
11	FP_Audio	Front Audio connector
12	BKL_CN	Back light brightness control connector
13	SYS_PANEL	Front panel header
14	LVDS	LVDS connector
15	LSW	LVDS resolution jumper
16	BATTERY	Battery cable connector
17	JCOM1	COM1 (COM RI# pin RI#/5V/12V Select)
18	RUSB1 RUSB2	USB 3.2 Gen 1 connector
19	HDMI2_DP	HDMI connector (Bottom) & DP connector (Top)
20	LAN1, LAN2	LAN connector

No	Code	Description
21	COM1	Serial Port connector
22	M2E1	M.2 Slot, E-key, NGFF2230, WiFi & Bluetooth module
23	M2M1	M.2 Slot, SATA/PCIeX4, NGFF2280
24	SIM-CARD	Sim Card slot
25	MPCIE	Mini PCIe full size, support 3G/4G module
26	SODIMM1 SODIMM2	DDR4 SO-DIMM Slot

## 3.2.1 CPU FAN (CPU FAN connector)

1

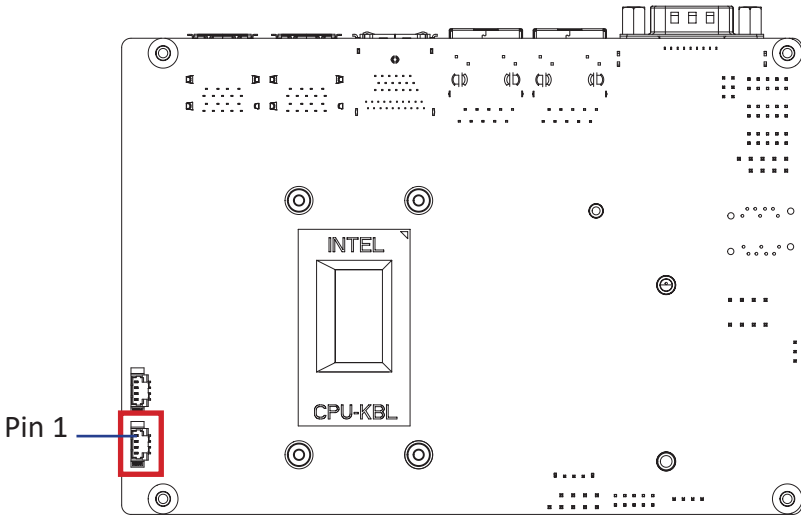

CPU FAN connector

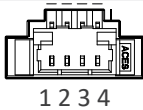

Connector PN	Vendor
85205-0470N	ACES
A1250WV-S-04PC	JOINT-TECH

Pin No.	Definition
1	GND
2	12V
3	Detect
4	Speed Control

## 3.2.2 System FAN (System FAN connector)

2

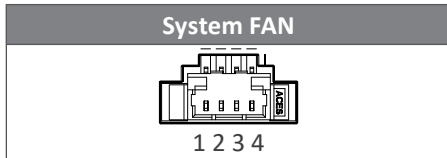
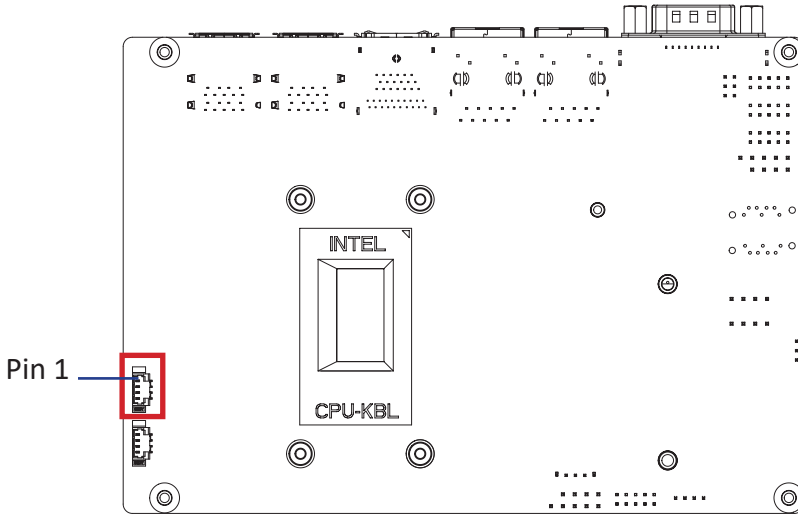

Connector PN	Vendor
85205-0470N	ACES
A1250WV-S-04PC	JOINT-TECH

Pin No.	Definition
1	GND
2	12V
3	Detect
4	Speed Control

## 3.2.3 COM2, COM3, COM4 (Serial port header)

3

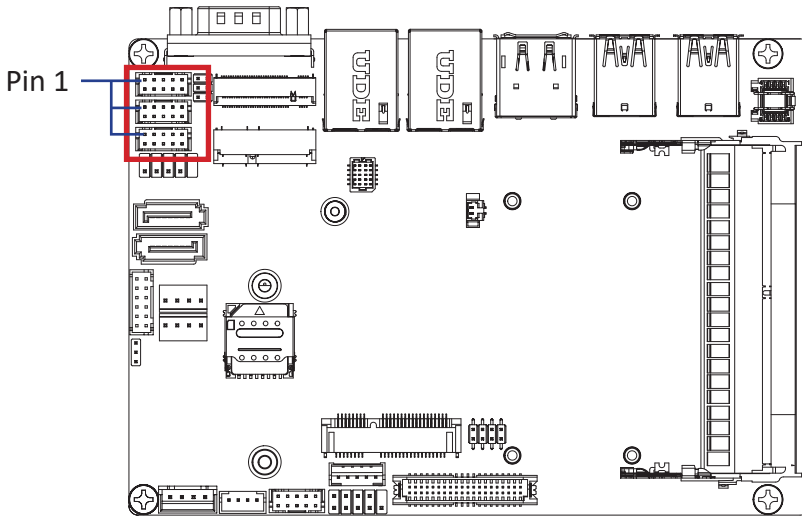

Serial Port Cable Connector



Connector PN

725-81-10TW00

Vendor

PINREX

A2004WV-2X05P46

JOINT-TECH

Pin No.

Definition

1	RXD
2	DCD
3	DTR
4	TXD
5	DSR
6	GND
7	CTS
8	RTS
9	No Connect
10	RI/ 5V/ 12V

### 3.2.4 FUSB (USB 2.0 header)

4

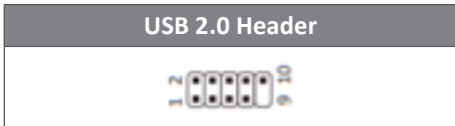
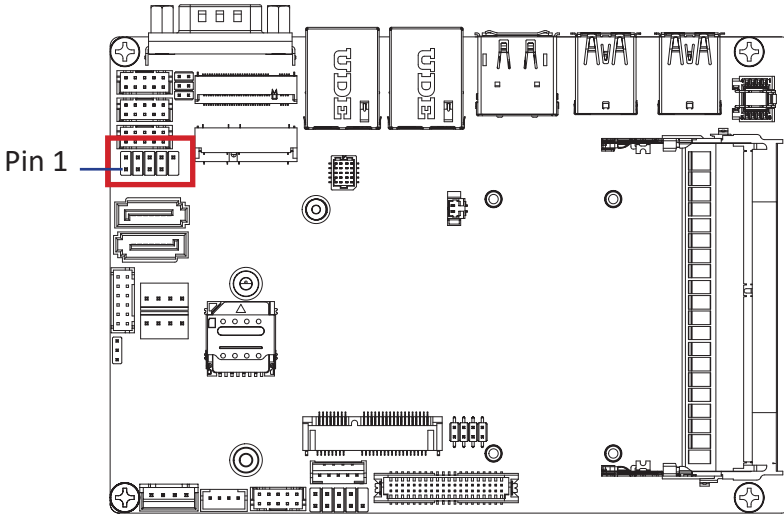

Connector PN	Vendor
210-92-05GB04	PINREX
PH10R53BAZ009	HORNGTONG

Pin No.	Definition
1	5V
2	5V
3	DX-
4	DY-
5	DX+
6	DY+
7	GND
8	GND
9	No Pin
10	No Connect



## 3.2.5 SATAIII\_0, SATAIII\_1 (SATA 6GB/S Connector)

5

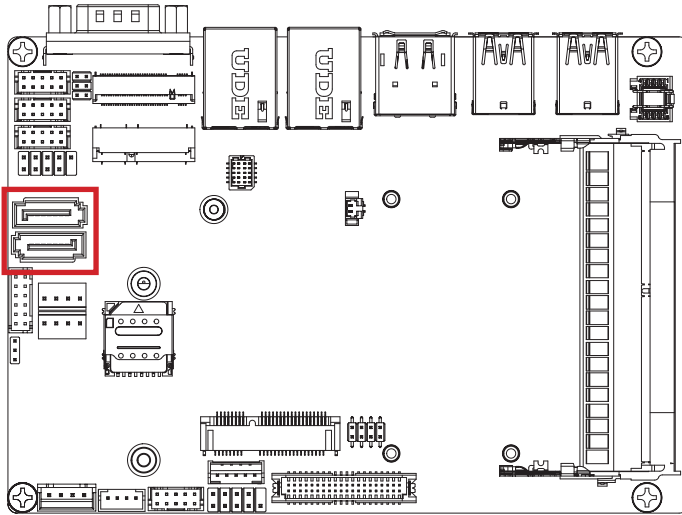

SATA Connector



SATAIII\_1,SATAIII\_0

Connector PN	Vendor
WATM-07ABNB2BAUW3	WINWIN
770-83-07SW19	PINREX

Pin No.	Definition
1	GND
2	TXP
3	TXN
4	GND
5	RXN
6	RXP
7	GND

### 3.2.6 GPIO\_CNT (General Purpose input/output header )

6

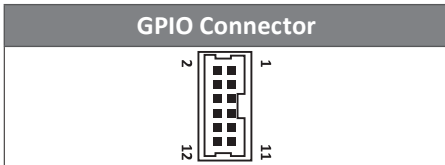
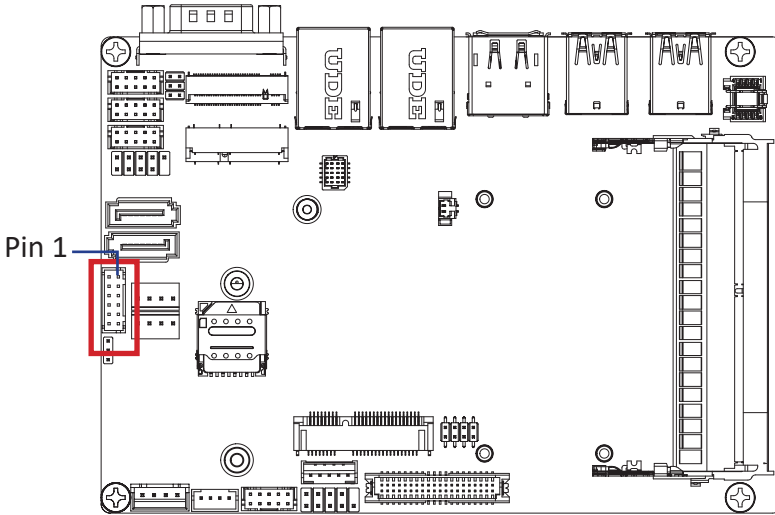

Connector PN	Vendor
725-81-12TW00	PINREX
A2004WV-2X06P46	JOINT-TECH

Pin No.	Definition
1	GPO1
2	GPI1
3	GPO2
4	GPI2
5	GPO3
6	GPI3
7	GPO4
8	GPI4
9	SMB_CLK
10	SMB_DATA
11	5V/ 1A
12	GND

## 3.2.7 SATAPW1, SATAPW2 (SATA 6Gb/s power connector)

7

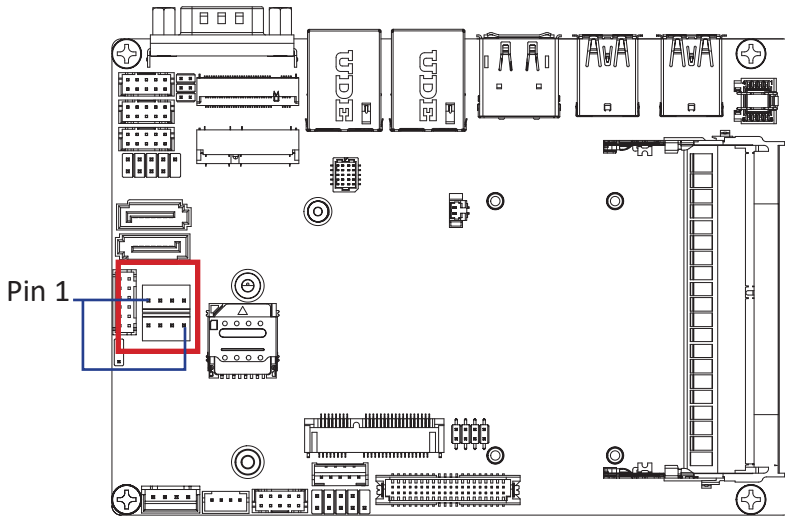

Hard Disk Power Connector



Connector PN

743-81-04TW00
WF04Q2-3BJQ000

Vendor

PINREX
HORNGTONG

Pin No. Definition

1	12V
2	GND
3	GND
4	5V

### 3.2.8 AT\_CN (AT/ATX power mode select jumper)

8

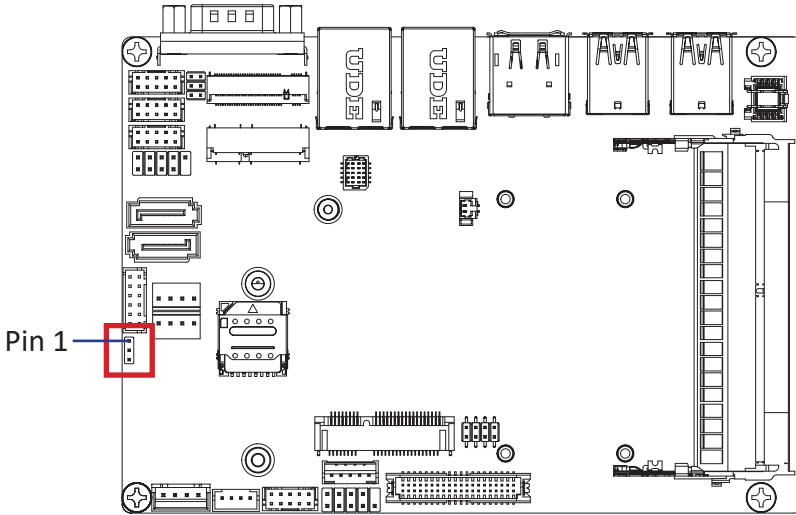

Pin 1

AT/ATX power mode select jumper	
	1

Connector PN	Vendor
220-96-03GB01	PINREX
PH03N2-7BAN000	HORNGTONG

Pin No.	Definition
1	AT MODE
2	TXD5
3	ATX MODE

Jumper setting  
 1-2 Close : AT mode.  
 2-3 Close : ATX mode.(Default setting)

## 3.2.9 DC\_IN (DC IN 1x4-pin power connector)

9

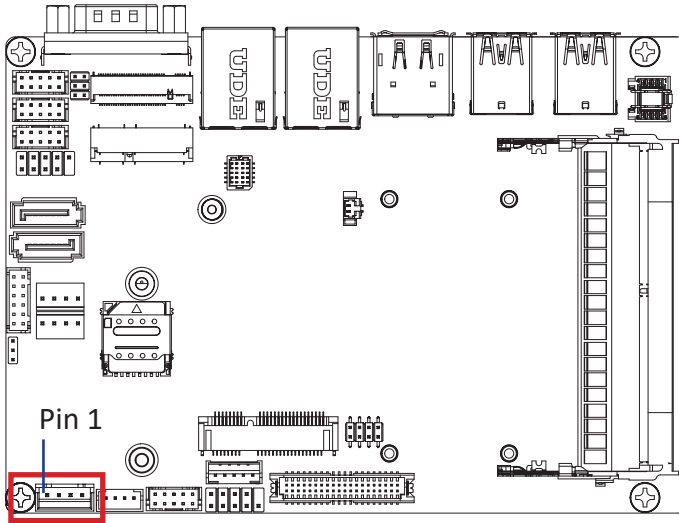

DC in connector



Connector PN

753-81-04TW00

Vendor

PINREX

Pin No.	Definition
1	GND
2	Power
3	Power
4	GND

### 3.2.10 SPK\_OUT (Speaker out connector)

10

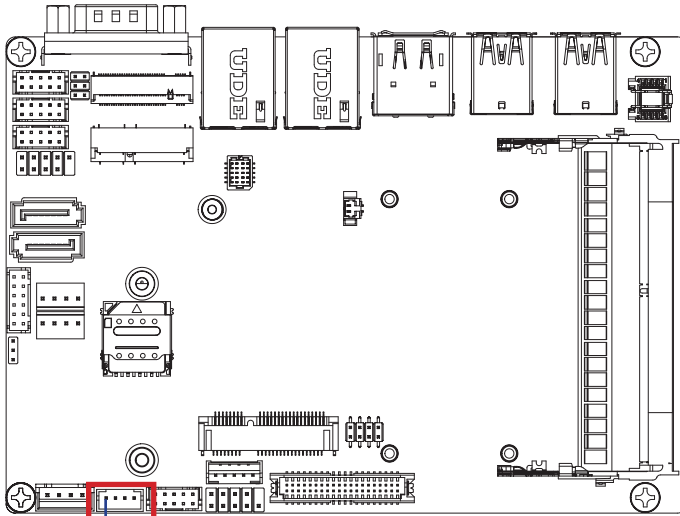

Pin 1

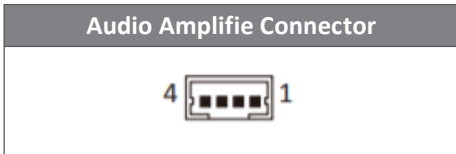

Connector PN	Vendor
721-81-045W00	PINREX
A2001WV-04P146	JOINT-TECH

Pin No.	Definition
1	Speaker Out L+
2	Speaker Out L-
3	Speaker Out R-
4	Speaker Out R+

## 3.2.11 FP\_Audio (Front Audio connector)

11

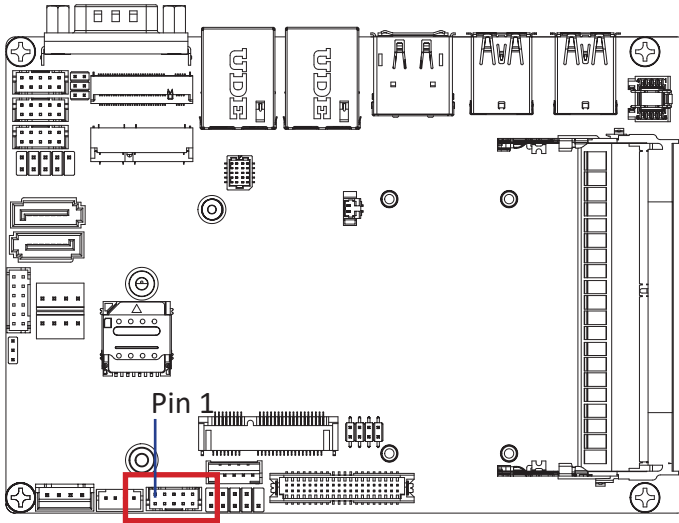

Front Audio Connector

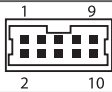

Connector PN

725-81-10TW00

A2004WV-2X05P46

Vendor

PINREX

JOINT-TECH

Pin No.	Definition
1	MIC_L
2	GND
3	MIC_R
4	Detect
5	HPOUT_R
6	GND
7	FAUDIO_JD
8	No Connect
9	HPOUT_L
10	GND

### 3.2.12 BKL\_CN (Back light brightness control connector)

12

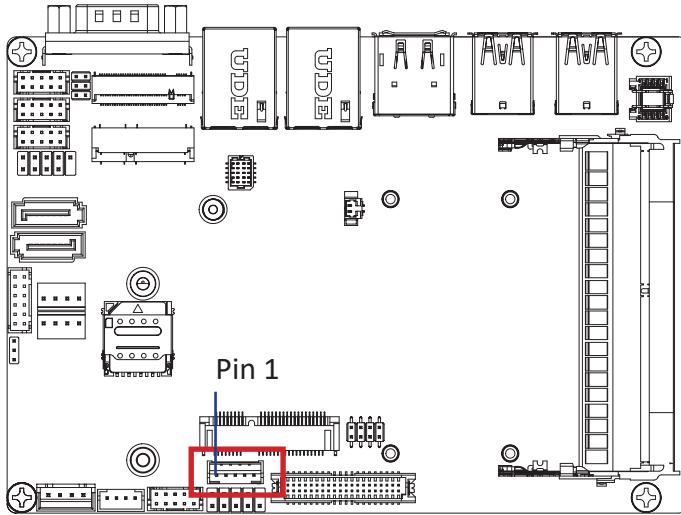

Back light brightness control connector	
1	5

Connector PN	Vendor
A2001WV-05P146	JOINT-TECH

Pin No.	Definition
1	5V
2	PWM
3	Back Light Enable
4	GND
5	12V

Connector PN	Vendor
721-81-05TW00	PINREX



## 3.2.13 SYS\_PANEL (Front panel header)

13

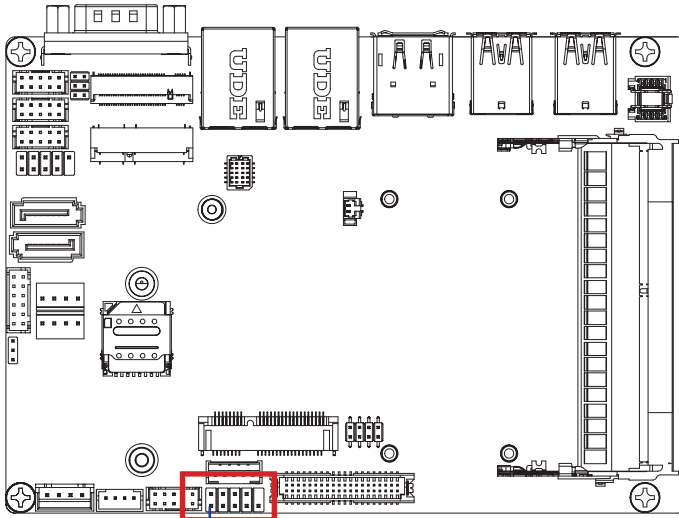

Pin 1

System Panel Header



Connector PN

210-92-05G111

Vendor

PINREX

Pin No.	Definition
1	HDD LED+
2	Power LED+
3	HDD LED-
4	Power LED-
5	GND
6	Power Button+
7	Reset Button
8	Power Button-
9	No Connect
10	No Pin

### 3.2.14 LVDS (LVDS connector)

14

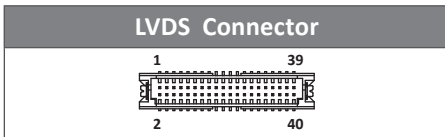
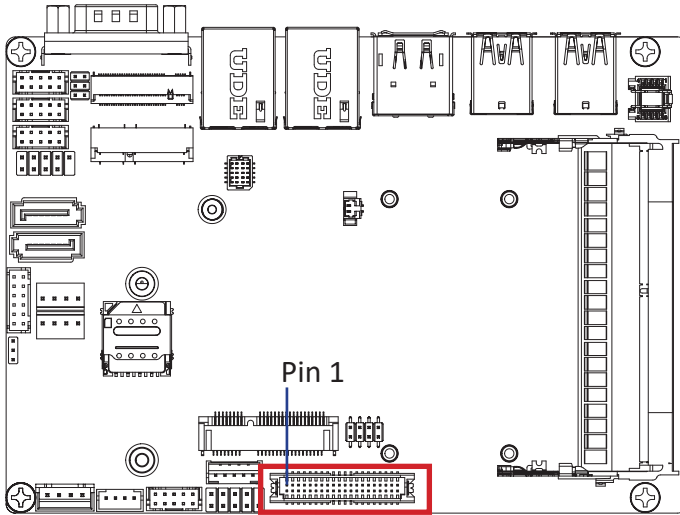

Pin No.	Definition	Pin No.	Definition
1	3.3V	21	A5+
2	5V	22	A4+
3	3.3V	23	A5-
4	5V	24	A4-
5	SPECO	25	GND
6	SPEDO	26	GND
7	GND	27	A7+
8	GND	28	A6+
9	A1+	29	A7-
10	A0+	30	A6-
11	A1-	31	GND
12	A0-	32	GND
13	GND	33	CLK2+
14	GND	34	CLK1+
15	A3+	35	CLK2-
16	A2+	36	CLK1-
17	A3-	37	GND
18	A2-	38	GND
19	GND	39	12V
20	GND	40	12V

Connector PN	Vendor
712-76-40GWE0	PINREX
A1252WV-SF-2X20PD01	JOINT-TECH

For each model support LVDS function.  
 But below model no need to add.  
 A0~A3 is odd channel 0~3, A4~A7 is even channel.







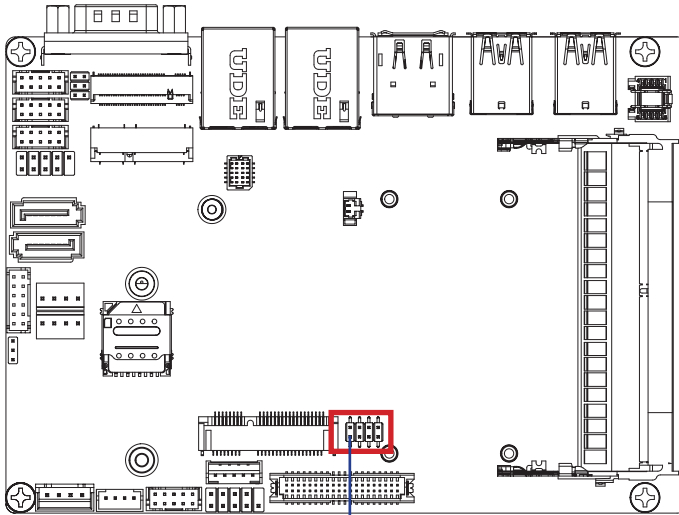









**Note:** \*The LVDS output connector of the unit is only intended to be connected to an UL/IEC/EN approval equipment with fire enclosure.

## 3.2.15 LSW (LVDS resolution jumper)

15



Pin 1

LVDS Resolution Jumper			
Jumper Setting	Resolution	Jumper Setting	Resolution
1 	800 x 600 18bit	1 	1366 x 768 24bit
1 	1024 x 768 18bit	1 	1440 x 900 24bit
1 	1024 x 768 24bit	1 	1400 x 1050 24bit
1 	1024 x 600 18bit	1 	1600 x 900 24bit
1 	1280 x 800 18bit	1 	1680 x 1050 24bit
1 	1280 x 960 18bit	1 	1600 x 1200 24bit
1 	1280 x 1024 24bit	1 	1920 x 1080 24bit
1 	1366 x 768 18bit	1 	1920 x 1200 24bit

Connector PN	Vendor
222-97-04GBE1	PINREX

### 3.2.16 BATTERY (Battery cable connector)

16

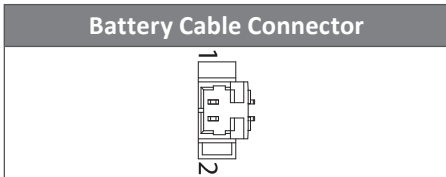
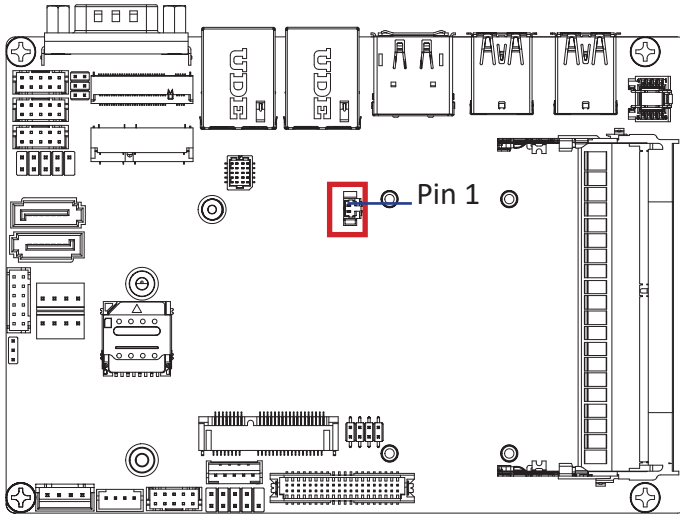

Connector PN	Vendor
85205-0270L	ACES
A1250WV-S-02PC	JOINT-TECH

Pin No.	Definition
1	3.3V
2	GND

## 3.2.17 JCOM1 (COM1 RI# pin RI#/5V/12V Select)

17

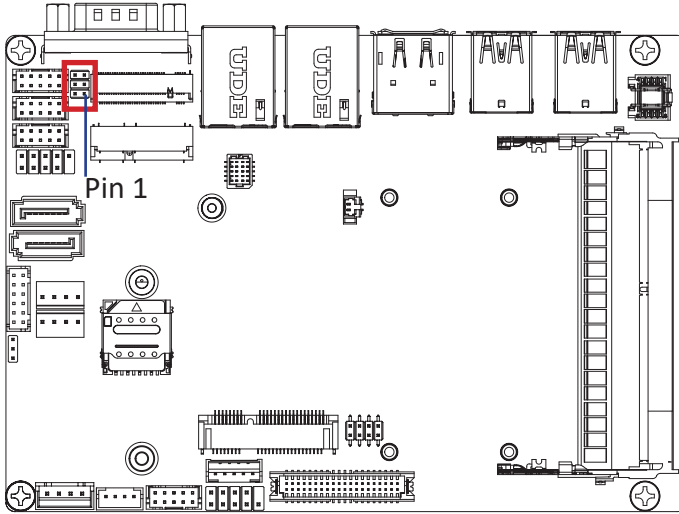

JCOM11 Jumper Select	
6 5  2 1	1-2 Close: 5V/ 1A (Power COM)
6 5  2 1	3-4 Close: RI (Stand COM)
6 5  2 1	5-6 Close: 12V/ 1A (Power COM)

Connector PN	Vendor
220-97-03GB01	PINREX
PH06N53BAZ000	HORNGTONG

