

QB-N150A

Industrial Embedded System
Quick Start Guide

Copyright Notice

This document is copyrighted, 2025. All rights are reserved. The original manufacturer reserves the right to make improvements to the products described in this manual at any time without notice.

No part of this manual may be reproduced, copied, translated, or transmitted in any form or by any means without the prior written permission of the original manufacturer. Information provided in this manual is intended to be accurate and reliable. However, the original manufacturer assumes no responsibility for its use, or for any infringements upon the rights of third parties that may result from its use.

The material in this document is for product information only and is subject to change without notice. While reasonable efforts have been made in the preparation of this document to assure its accuracy, GIGAIPC assumes no liabilities resulting from errors or omissions in this document, or from the use of the information contained herein.

GIGAIPC reserves the right to make changes in the product design without notice to its users.

Acknowledgement

All other products' name or trademarks are properties of their respective owners.

- Microsoft Windows is a registered trademark of Microsoft Corp.
- Intel, Pentium, Celeron, and Xeon are registered trademarks of Intel Corporation
- Core, Atom are trademarks of Intel Corporation
- ITE is a trademark of Integrated Technology Express, Inc.
- IBM, PC/AT, PS/2, and VGA are trademarks of International Business Machines Corporation.

All other product names or trademarks are properties of their respective owners.

Packing List

Before setting up your product, please make sure the following items have been shipped:

Item	Quantity
System kit	1
19V / 65W adapter	1
Power cord (May vary based on local distribution)	1
VESA Bracket	1
VESA screw (M4-10L x 4pcs, M3-3L x 2pcs)	1

If any of these items are missing or damaged, please contact your distributor or sales representative immediately.

About this Document

This User's Manual contains all the essential information, such as detailed descriptions and explanations on the product's hardware and software features (if any), its specifications, dimensions, jumper/connector settings/definitions, and driver installation instructions (if any), to facilitate users in setting up their product.

Users may refer to the GIGAIPC.com for the latest version of this document.

Safety Precautions

Please read the following safety instructions carefully. It is advised that you keep this manual for future references

1. All cautions and warnings on the device should be noted.
2. Make sure the power source matches the power rating of the device.
3. Position the power cord so that people cannot step on it. Do not place anything over the power cord.
4. Always completely disconnect the power before working on the system's hardware.
5. No connections should be made when the system is powered as a sudden rush of power may damage sensitive electronic components.
6. If the device is not to be used for a long time, disconnect it from the power supply to avoid damage by transient over-voltage.
7. Always disconnect this device from any AC supply before cleaning.
8. While cleaning, use a damp cloth instead of liquid or spray detergents.
9. Make sure the device is installed near a power outlet and is easily accessible.
10. Keep this device away from humidity.
11. Place the device on a solid surface during installation to prevent falls
12. Do not cover the openings on the device to ensure optimal heat dissipation.

13. Watch out for high temperatures when the system is running.
14. Do not touch the heat sink or heat spreader when the system is running
15. Never pour any liquid into the openings. This could cause fire or electric shock.
16. As most electronic components are sensitive to static electrical charge, be sure to ground yourself to prevent static charge when installing the internal components. Use a grounding wrist strap and contain all electronic components in any static-shielded containers.
17. If any of the following situations arises, please the contact our service personnel:
 - i. Damaged power cord or plug
 - ii. Liquid intrusion to the device
 - iii. Exposure to moisture
 - iv. Device is not working as expected or in a manner as described in this manual
 - v. The device is dropped or damaged
 - vi. Any obvious signs of damage displayed on the device
- 18. DO NOT LEAVE THIS DEVICE IN AN UNCONTROLLED ENVIRONMENT WITH TEMPERATURES BEYOND THE DEVICE'S PERMITTED STORAGE TEMPERATURES (SEE CHAPTER 1) TO PREVENT DAMAGE.**

FCC Statement

Warning!



This device complies with Part 15 FCC Rules. Operation is subject to the following two conditions: (1) this device may not cause harmful interference, and (2) this device must accept any interference received including interference that may cause undesired operation.

Caution:

There is a danger of explosion if the battery is incorrectly replaced. Replace only with the same or equivalent type recommended by the manufacturer. Dispose of used batteries according to the manufacturer's instructions and your local government's recycling or disposal directives.

Attention:

Il y a un risque d'explosion si la batterie est remplacée de façon incorrecte. Ne la remplacer qu'avec le même modèle ou équivalent recommandé par le constructeur. Recycler les batteries usées en accord avec les instructions du fabricant et les directives gouvernementales de recyclage.

High Temperature Warning

(1) This equipment is intended to be used in Restrict Access Location. The access can only be gained by Skilled person or by Instructed person who have been instructed about the metal chassis of the equipment is so hot that Skilled person have to pay special attention or take special protection.

Only authorized by well trained professional person can access the restrict access location.

(2) External metal parts are hot!! Before touching it, special attention or protection is necessary



Table Contents

Industrial Embedded System	1
Quick Start Guide	
Copyright Notice	2
Acknowledgement	3
Packing List.....	4
About this Document	5
Safety Precautions	6
FCC Statement.....	8
High Temperature Warning	8
Chapter 1 - Product Specifications	12
1.1 Specifications	14
Chapter 2 – Industrial Embedded System Kit	16
2.1 Dimension	17
2.2 Getting Familiar with Your Unit.....	18
2.3 A) Wireless Module : How to safely install the Module (Wireless Module inclusion may vary based on local distribution)	20
2.4 B) M.2 SSD Installation: How to safely install the M.2 2280 SSD)	21
2.5 C) Memory Installation: DDR5 SO-DIMM	22
2.6 Antenna Installation (Antenna inclusion may vary based on local distribution)	23
2.7 VESA Bracket	24

2.8	Support	25
2.9	Safety and Regulatory Information.....	26

Chapter 3 – Hardware Information 27

3.1	Jumpers and Connectors	28
3.2.1	PWR_BT (Power Button header)	31
3.2.2	ME (ME status jumper)	32
3.2.3	M2M (M.2 Slot, 2280 M-Key)	33
3.2.4	F_USB2_1, F_USB2_2 (USB 2.0 header)	34
3.2.5	M2E (M.2 Slot, 2230 E-Key)	35
3.2.6	BATTERY (Battery connector)	36
3.2.7	SATA_PWR (SATA power connector)	37
3.2.8	SATA (SATA 6Gb/s connector)	38
3.2.9	DC_IN2 (DC IN Connector).....	39
3.2.10	SODIMM (DDR5 SO-DIMM Slot)	40
3.2.11	CPU FAN (CPU Fan connector)	41
3.2.12	USB3CM (USB Type C Port).....	42
3.2.13	COM1 (Serial port connector, RS-232).....	43
3.2.14	HP (Combo audio jack (Headphone & Headset)).....	44
3.2.15	USB31_2 (USB 3.2 Gen 2x1 connector)	45
3.2.16	PWR_BUT (Power button)	46
3.2.17	DC_IN1 (Screw type DC Jack connector)	47
3.2.18	USB31_1 (USB 3.2 Gen 2x1 connector)	48
3.2.19	HDMI2_21 (HDMI connector).....	49
3.2.20	LAN1, LAN2 (LAN connector).....	50

Chapter 4 – BIOS	51
4.1 Introduction	52
4.2 The Main Menu.....	53
4.3 Advanced	54
4.3.1 TPM Configuration.....	55
4.3.2 CPU Configuration	57
4.3.3 Memory Configuration	58
4.3.4 SATA Configuration	59
4.3.5 Super IO Configuration	60
4.3.6 Hardware Monitor	61
4.3.7 S5 RTC Wake Settings	62
4.3.8 Network Stack Configuration-1.....	63
4.3.8 Network Stack Configuration-2	64
4.3.9 NVMe Configuration.....	65
4.3.10 Tls Auth Configuration	66
4.3.11 Realtek PCIe GBE Family Controller (MAC:30:56:0F:45: 78:10) (MAC address may varied based on different motherboard).....	67
4.3.12 Realtek PCIe GBE Family Controller (MAC:30:56:0F:45: 78:11) (MAC address may varied based on different motherboard).....	68
4.4 Chipset	69
4.5 Security	70
4.6 Boot.....	73
4.7 Save & Exit	74

Chapter 1

Chapter 1 - Product Specifications

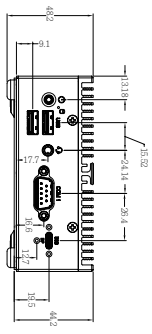
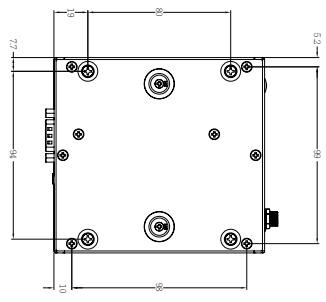
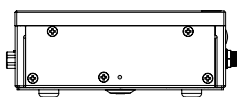
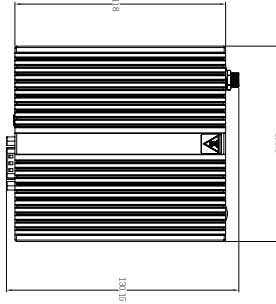
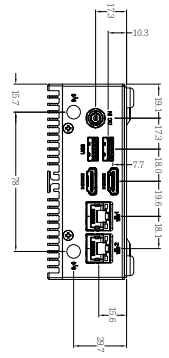
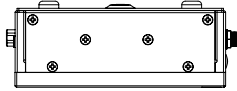

1.1 Specifications

System	QB-N150A (QB-N150A-SI)
Dimension	118W x 109.4D x 44.4H (mm)
CPU	Intel® Processor N150 Intel® 7, 4 cores, up to 3.60 GHz
Memory	1 x DDR5 SO-DIMM socket, Max. Capacity 16 GB Support Single Channel DDR5 4800 MHz memory module
Ethernet	2 x GbE LAN Ports (Realtek® RTL8111H)
Video	Integrated Graphics Processor - Intel® Graphics support: 2 x HDMI 2.0 port, supporting a maximum resolution of 4096x2160 @60Hz 1 x DP 1.4 through USB Type C (DP Alt.mode), supporting a maximum resolution of 4096x2160 @60Hz (3 independent display outputs)
Audio	Realtek® ALC269
Expansion Slots	1 x 2280 M.2 M-Key (PCIe Gen 3x1, SATA 6Gb/s) 1 x 2230 M.2 E-Key (WiFi/BT)
Front I/O	2 x USB 3.2 Gen 2x1 1 x COM Port (RS-232) 1 x Combo Audio Jack (Headphone & Headset) 1 x Power button with LED 1 x USB 3.2 Type C with DP 1.4b (DP Alt. mode)
Rear I/O	2 x RJ45 LAN Ports 2 x USB 3.2 Gen 2x1 2 x HDMI 2 x External Antenna Holes (Optional) 1 x Screw Type DC Jack
TPM	Onboard TPM 2.0 security chip NUVOTON NPCT760AABYX
Power	+12V~19VDC (Adapter 19V/65W)
Operation Temperature	Operating temperature: 0°C to 50°C Operating humidity: 40°C @ 20-95% (non-condensing) Non-operating temperature: -40°C to 85°C Non-operating humidity: 60°C @ 95% (non-condensing) Use wide temperature range memory and storage

System	QB-N150A (QB-N150A-SI)
Vibration During Operation	Operation: IEC 60068-2-64, 3 Grms, random, 5 ~ 500 Hz, 1 hr / Per Axis, With SSD Non-operation: IEC 60068-2-6, 2 G, Sine, 10 ~ 500 Hz, 1 Oct/min, 1 hr / Per Axis
Shock During Operation	Operation: IEC 60068-2-27, 50 G, half sine, 11 ms duration with SSD
Packaging Content	Carton size: 373 x 294 x 296 (mm) Packing Capacity: 8pcs Single Box size: 256 x 173 x 66 (mm) Including: Power Cord : Optional (by region) PSU ADP 19V 65W 100-240VAC x 1 (P/N: 25EP0-1065W1-A3S) VESA Bracket x 1 (P/N: 25HB1-TPL021-S8R) VESA Screws x 1 (P/N: 25KSD-000002-COR)
Order Information	System : 6BQBN150AMR-SI (Box packing)

Chapter 2

Chapter 2 – Industrial Embedded System Kit

2.1 Dimension

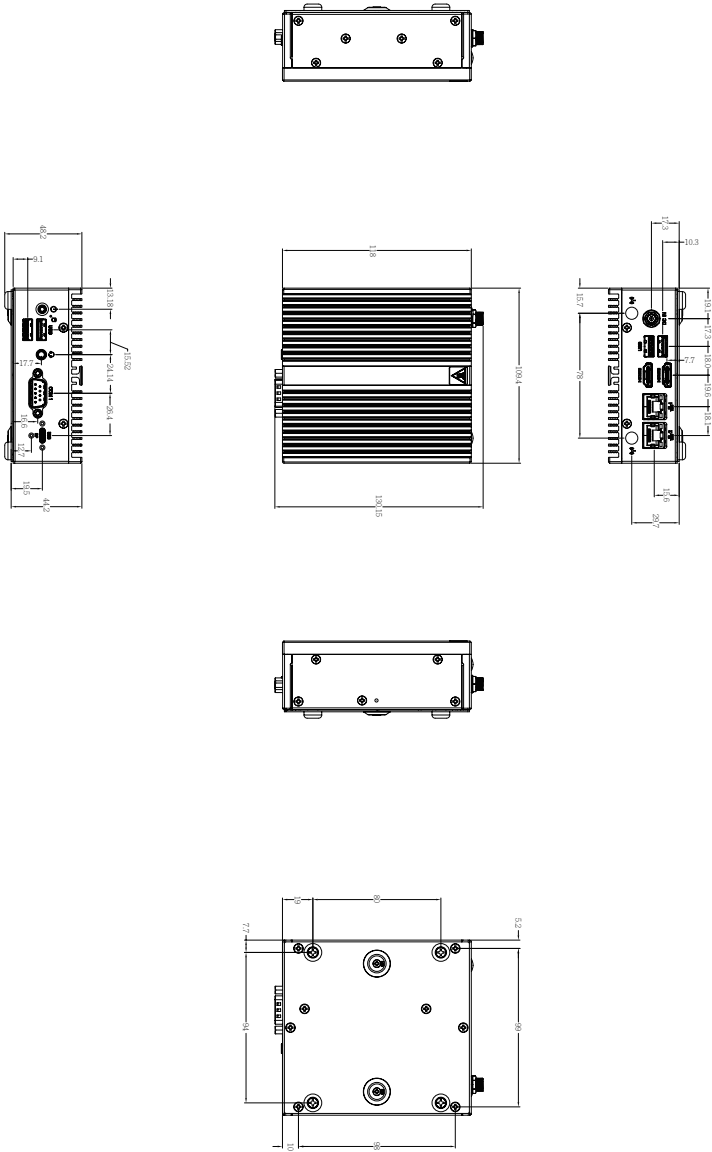

2.2 Getting Familiar with Your Unit

[Front Side]

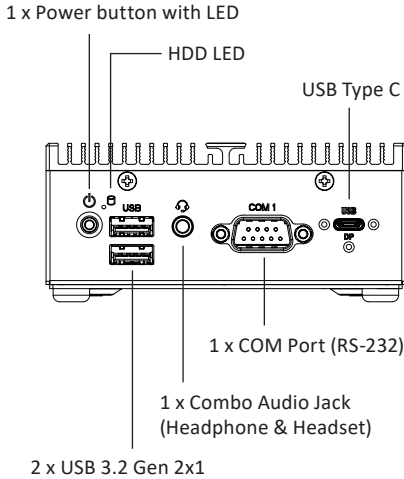

[Left Side]

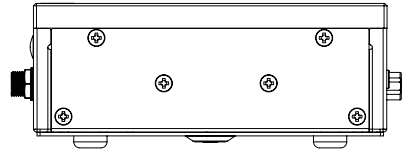

[Right Side]

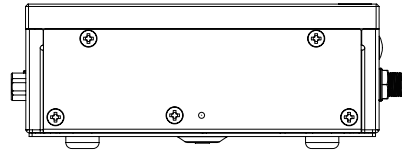

[Rear Side]

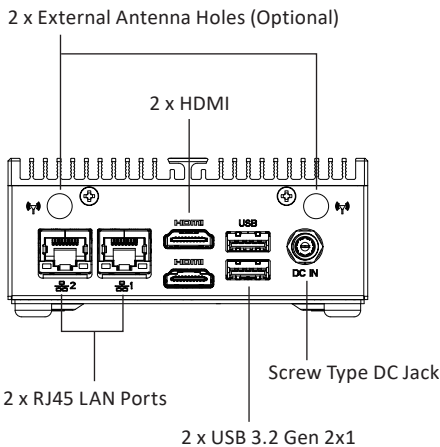

[Bottom Side]

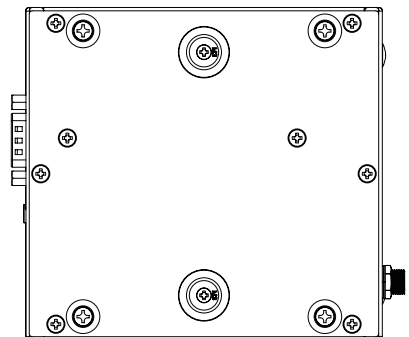

[Install]

- * Before opening the case, make sure to unplug the power cord.
- * Before Connecting the power, make sure to fasten the case securely.

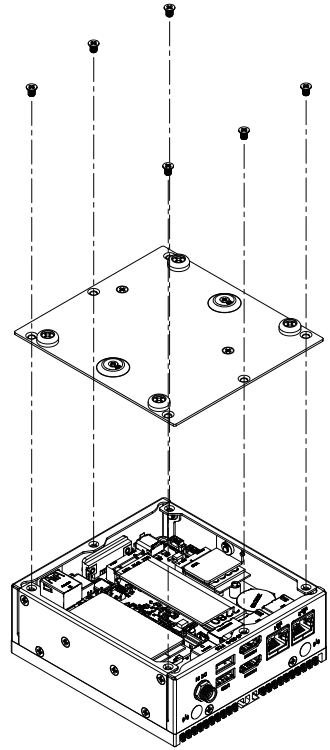

[Bottom PCB Side]

Information	
A	1 x M.2 slot, 2230 M-key
B	1 x M.2 slot, 2280 E-key
C	1 x DDR5 SO-DIMM socket

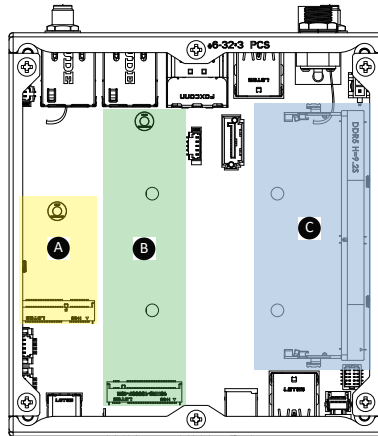

2.3 A) Wireless Module : How to safely install the Module (Wireless Module inclusion may vary based on local distribution)

1

Remove the screw from the screw hole (Location : MSO1)

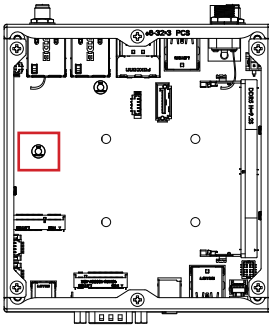

2

Carefully insert the wireless module into the M.2 slot.

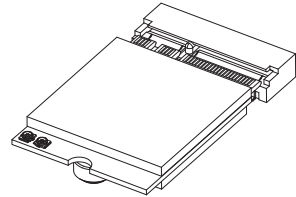

3

Lock the screw in the middle.

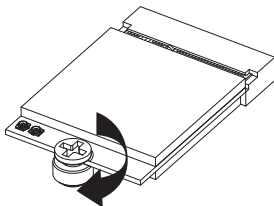

4

Install the antenna on the left side of the connection wireless module down.

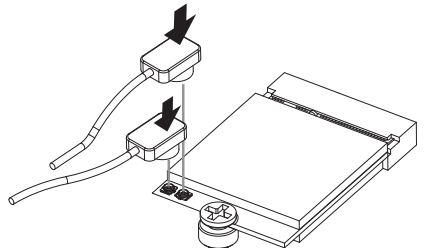

2.4 B) M.2 SSD Installation: How to safely install the M.2 2280 SSD)

1

Remove the screw from the screw hole (Location : MSO2)

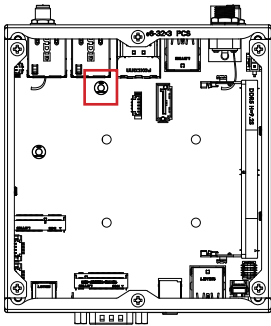

2

Carefully insert the M.2 SSD into the slot, and secure with the screw.

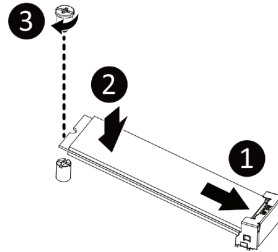

2.5 C) Memory Installation: DDR5 SO-DIMM

1

Carefully insert SO-DIMM memory modules.

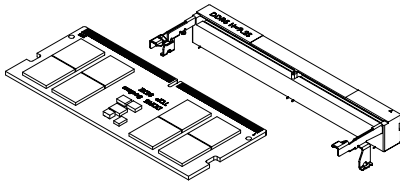
**2**

Push down until the module click into place.

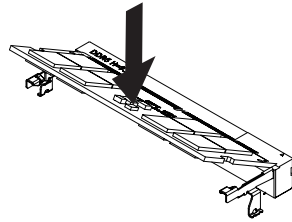
**3**

Make sure the module is completely installed.

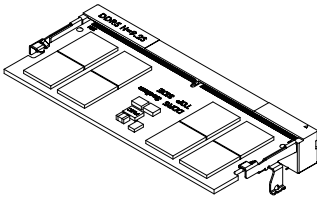

2.6 Antenna Installation (Antenna inclusion may vary based on local distribution)

1

Carefully insert the antennas into the connectors.

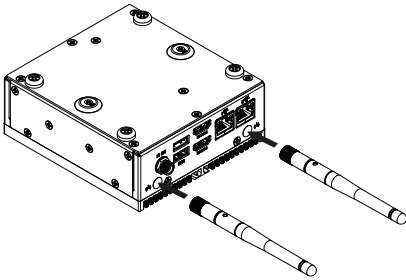

2

Turn the antennas clockwise until they are completely secure on the connectors.

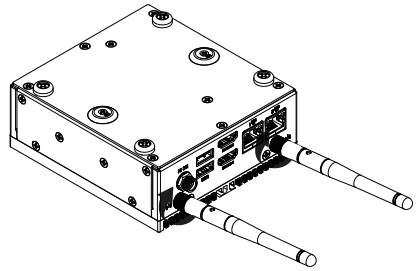

3

Flip up the antenna heads so that they are perpendicular to the machine.

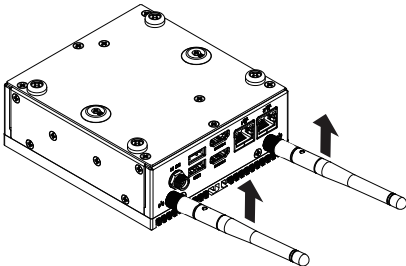

2.7 VESA Bracket

1

Attached the screws which provided with the QBiX.

Screws type : M3-3L x 2pcs

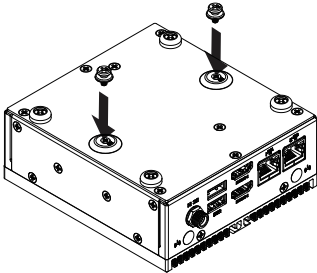
**2**

Attached the VESA mounting plate to the rear of a compatible display using the screws provided with the QBiX.

VESA hole patterns : 75 x 75mm and 100 x 100mm
Screws type : M4-10L x 4pcs

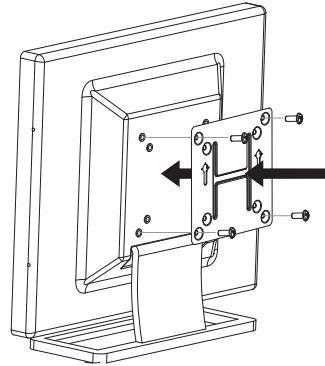
**3**

The QBiX can now be mounted by sliding the device into place.

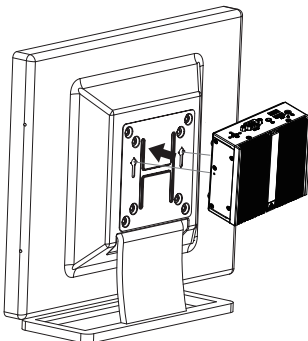

2.8 Support

- For AVL list, go to: <http://www.gigaipc.com>
- To download the latest drivers, go to: <http://www.gigaipc.com>
- For product support, go to: <http://www.gigaipc.com>

2.9 Safety and Regulatory Information

Risk of explosion if the battery is replaced with an incorrect type. Batteries should be recycled where possible.

Disposal of used Batteries must be in accordance with local environmental regulations.

Failure to use the included Power Adapter may violate regulatory compliance and may expose the user to safety hazards.

HDMI™
HIGH DEFINITION MULTIMEDIA INTERFACE



At the end of its serviceable life, this product should not be treated as household or general waste. It should be handed over to the applicable collection point for the recycling of electrical and electronic equipment, or returned to the supplier for disposal.

Chapter 3

Chapter 3 – Hardware Information

3.1 Jumpers and Connectors

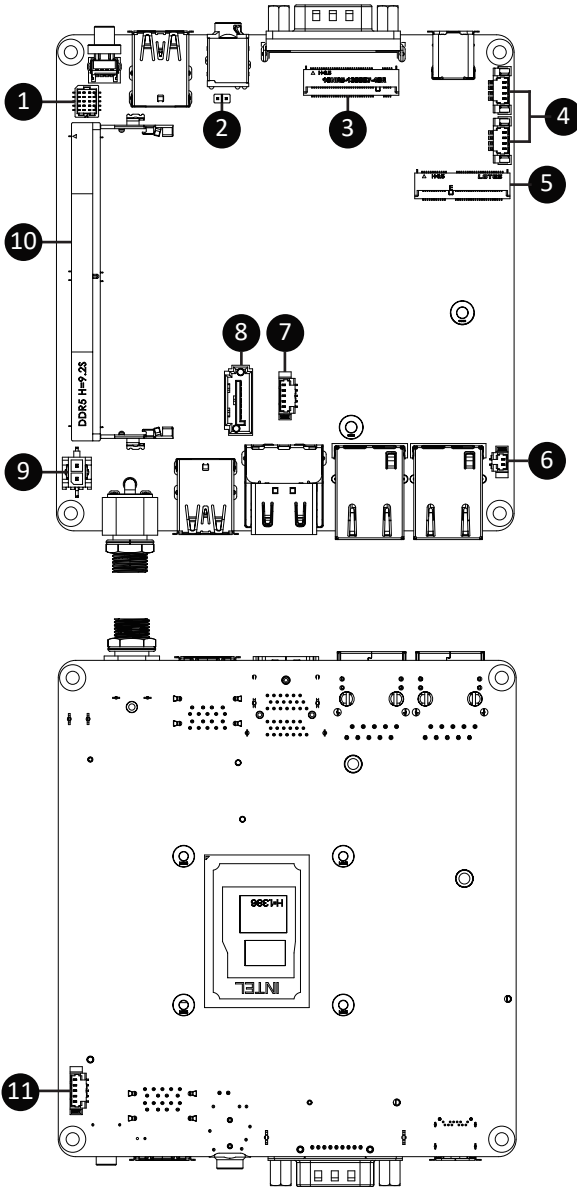

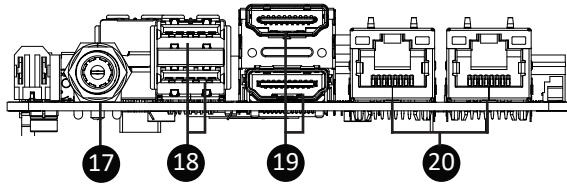
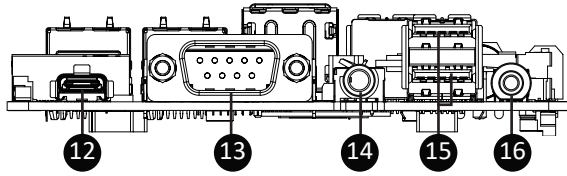

No	Code	Description
1	PWR_BT	Power Button header
2	ME	ME status header
3	M2M	M.2 Slot, 2280 M-key
4	F_USB2_1 F_USB2_2	USB 2.0 header
5	M2E	M.2 Slot, 2230 E-key
6	BATTERY	Battery connector
7	SATA_PWR	SATA power connector
8	SATA	SATA 6Gb/s connector

No	Code	Description
9	DC_IN2	DC IN connector
10	SODIMM	DDR5 SO-DIMM Slot
11	CPU FAN	CPU Fan connector
12	USB3CM	USB Type C Port
13	COM1	Serial port connector (RS-232)
14	HP	Combo Audio Jack (Headphone & Headset)
15	USB31_2	USB 3.2 Gen 2x1 port x 2
16	PWR_BUT	Power button
17	DC_IN1	Screw type DC Jack
18	USB31_1	USB 3.2 Gen 2x1 port x 2
19	HDMI2_21	HDMI connector x 2
20	LAN1 LAN2	LAN Connector x 2

3.2.1 PWR_BT (Power Button header)

1

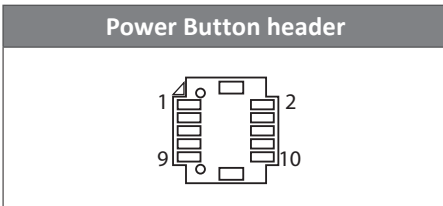
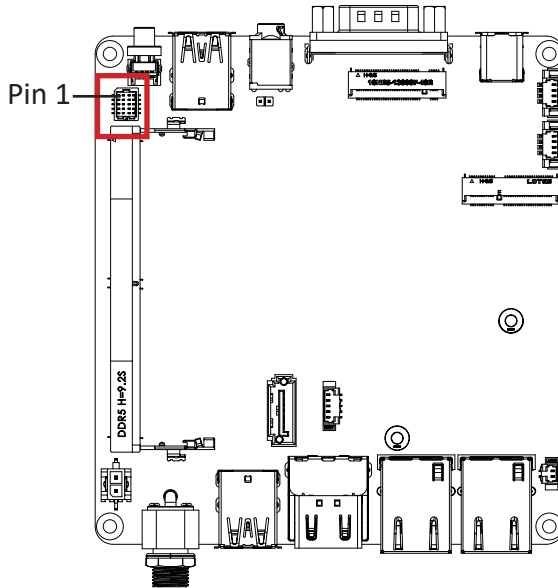

Connector PN	Vendor
50238-01041-001	ACES

Connector type
2x5pin header, pitch 1.0mm

Pin No.	Definition
1	PWRBTSW
2	GND
3	5Vdual
4	MPD-
5	NC
6	HD-
7	NC
8	NC
9	HD+
10	NC

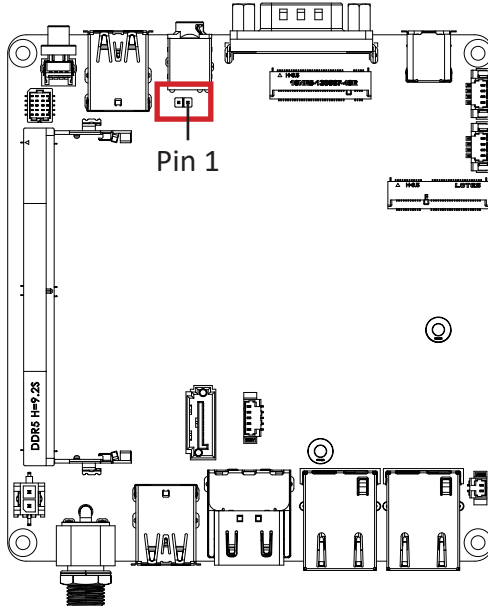

3.2.2 ME (ME status jumper)

2



ME status jumper	
	
1	

Connector type
1x2pin header, pitch 2.0mm

ME Enable Jumper	
	Enable
	Disable

3.2.3 M2M (M.2 Slot, 2280 M-Key)

3

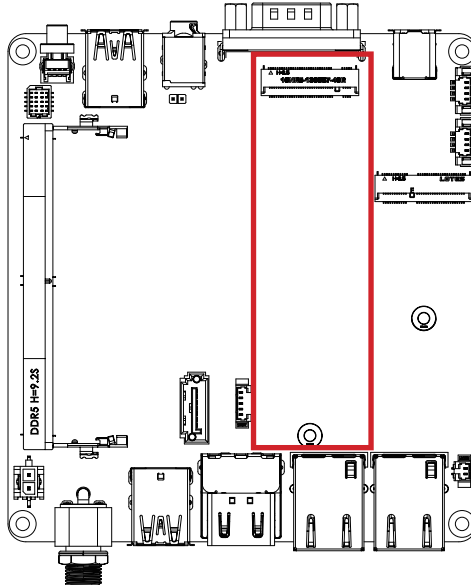

M.2 M Key Connector			
1	75		
2	74		

Pin No.	Definition	Pin No.	Definition
1	GND	2	3.3V
3	GND	4	3.3V
5	NC	6	NC
7	NC	8	NC
9	GND	10	SSD LED
11	NC	12	3.3V
13	NC	14	3.3V
15	GND	16	3.3V
17	NC	18	3.3V
19	NC	20	NC
21	GND	22	NC
23	NC	24	NC
25	NC	26	NC
27	GND	28	NC
29	NC	30	NC
31	NC	32	NC
33	GND	34	NC
35	NC	36	NC
37	NC	38	DEVS LP

Pin No.	Definition	Pin No.	Definition
39	GND	40	SMB_CLK
41	PCIE Rxp/SATA Rxp	42	SMB_DATA
43	PCIE Rxn/SATA Rxn	44	SMB_Alert
45	GND	46	NC
47	PCIE TXn/SATA TXn	48	NC
49	PCIE TXp/SATA TXp	50	PLT_Reset
51	GND	52	CK_Request
53	Clock n	54	PCIE_Wake up
55	Clock p	56	NC
57	GND	58	NC

Pin No.	Definition	Pin No.	Definition
67	NC	68	SUSCLK
69	Detect	70	3.3V
71	GND	72	3.3V
73	GND	74	3.3V
75	GND		

Connector PN	Vendor
80159-8521	BELLWETHER
2E0BC21-S85BM-7H	FOXCONN
APCI0096-P002A	LOTES

3.2.4 F_USB2_1, F_USB2_2 (USB 2.0 header)

4

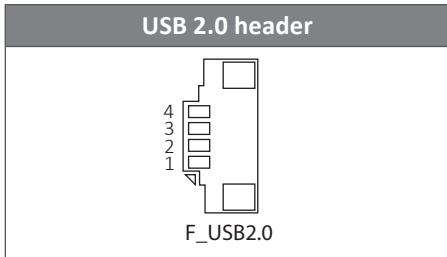
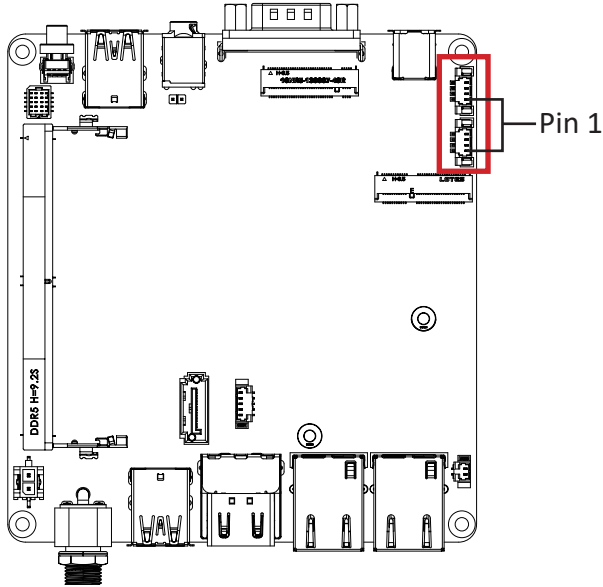

Connector PN	Vendor
A1250WV-S-04PNLBT1T00L	JOINT-TECH
50273-0047N-001	ACES

Connector type
1x4pin header, pitch 1.25mm

Pin No.	Definition
1	5V
2	D1n
3	D1p
4	GND

3.2.5 M2E (M.2 Slot, 2230 E-Key)

5

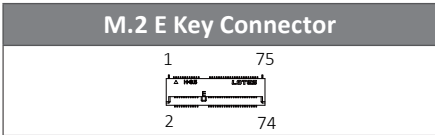
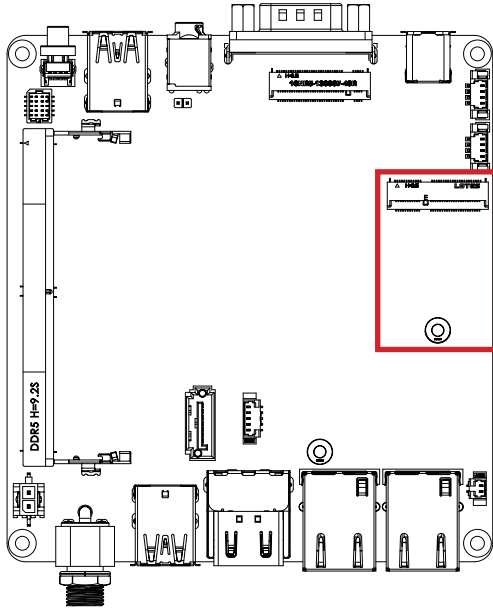

Pin No.	Definition	Pin No.	Definition
1	GND	2	3.3V
3	D1p	4	3.3V
5	D1n	6	NC
7	GND	8	NC
9	NC	10	NC
11	NC	12	NC
13	NC	14	NC
15	NC	16	NC
17	NC	18	GND
19	NC	20	NC
21	NC	22	NC
23	NC		

Pin No.	Definition	Pin No.	Definition
33	GND	32	NC
35	PCIE TXp	34	NC
37	PCIE TXn	36	NC

39	GND	38	NC
41	PCIE RXp	40	NC
43	PCIE RXn	42	NC
45	GND	44	NC
47	PCIE Clock p	46	NC
49	PCIE Clock n	48	NC
51	GND	50	SUSCLK
53	PCIE Clock Request	52	Reset
55	PCIE Wakeup	54	BT_Disable
57	GND	56	WLAN_Disable
59	NC	58	NC
61	NC	60	NC
63	GND	62	NC
65	NC	64	NC
67	NC	66	NC
69	GND	68	NC
71	NC	70	NC
73	NC	72	3.3V
75	GND	74	3.3V

Connector PN	Vendor
80152-8521	BELLWETHER
APCI0095-P002A	LOTES

3.2.7 SATA_PWR (SATA power connector)

7

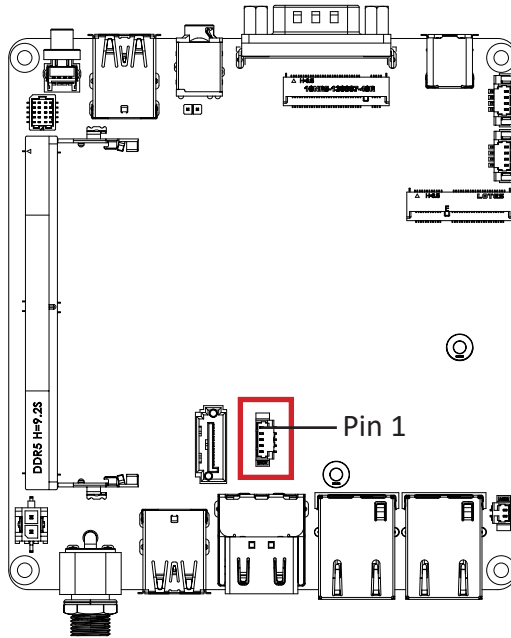

SATA power connector



Connector PN

85205-0570N

Vendor

ACES

Connector type

1x5pin header, pitch 1.25mm

Pin No.	Definition
1	5V
2	5V
3	3.3V
4	GND
5	GND

3.2.9 DC_IN2 (DC IN Connector)

9

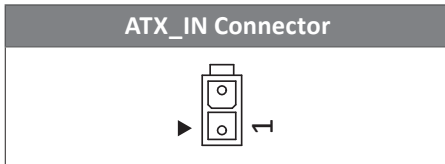
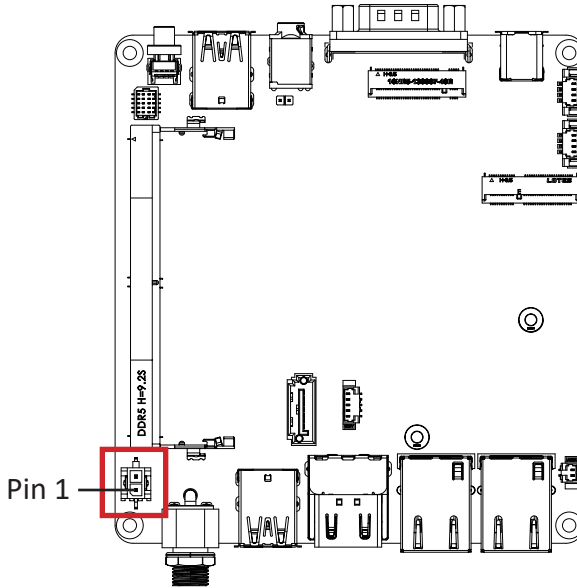

Connector PN	Vendor
99-01740-B004-A	TCONN
Connector type	
1x2pin header, pitch 3.0mm	

Pin No.	Definition
1	GND
2	DC IN

3.2.10 SODIMM (DDR5 SO-DIMM Slot)

10

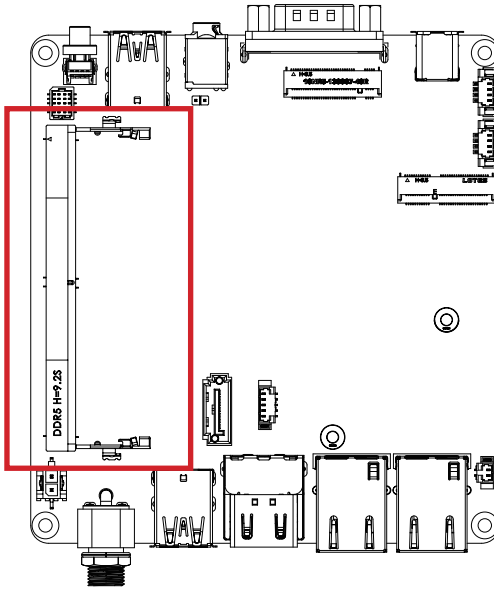

3.2.11 CPU FAN (CPU Fan connector)

11

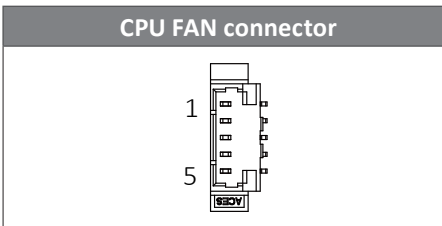
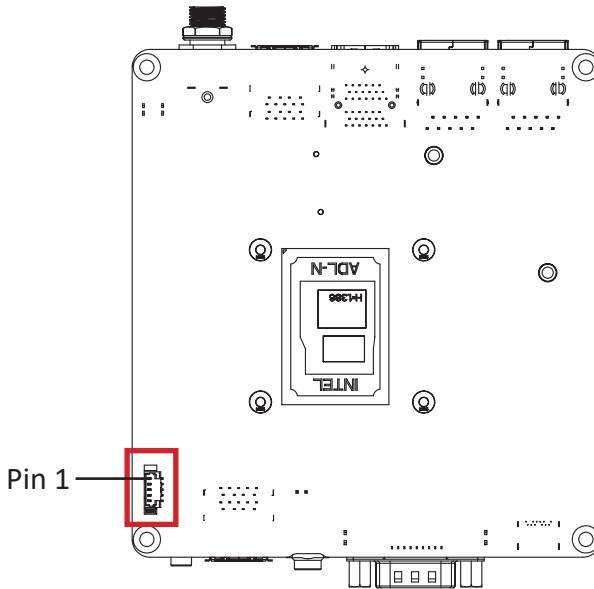

Connector PN	Vendor
85205-0570N	ACES

Connector type
1x5pin header, pitch 1.25mm

Pin No.	Definition
1	GND
2	VCC
3	CPUFANIN
4	FAN1_PWM
5	NC

3.2.12 USB3CM (USB Type C Port)

12

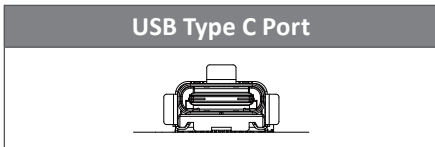
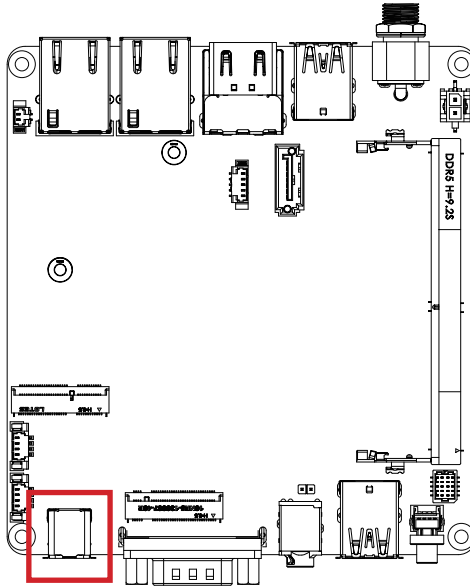

Connector PN	Vendor
UT1111C-1340F-7H	FOXCONN

Pin No.	Definition	Pin No.	Definition
A1	GND	B12	GND
A2	TX0_P	B11	RX0_P
A3	TX0_N	B10	RX0_N
A4	USB_VBUS	B9	USB_VBUS
A5	CC1	B8	SBU2
A6	USBP5_P	B7	USBP5_N
A7	USBP5_N	B6	USBP5_P
A8	SBU1	B5	CC2
A9	USB_VBUS	B4	USB_VBUS
A10	RX1_N	B3	TX1_N
A11	RX1_P	B2	TX1_P
A12	GND	B1	GND

3.2.13 COM1 (Serial port connector, RS-232)

13

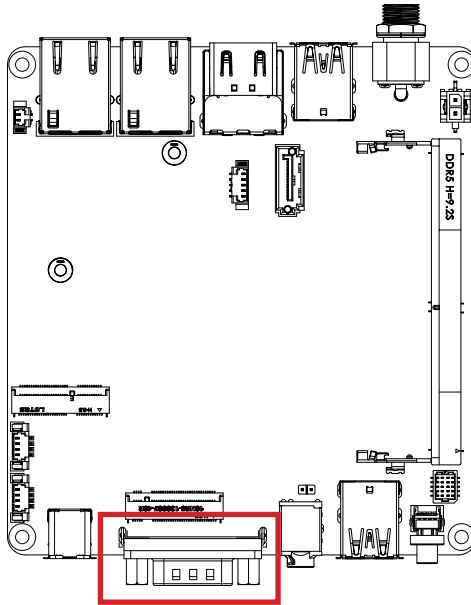

Serial port Connector

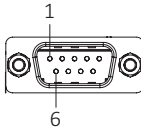

Connector PN	Vendor
SM41D1P1122N33NQq	FENYING

Pin No.	Definition
1	DCD
2	RXD
3	TXD
4	DTR
5	GND
6	DSR
7	RTS
8	CTS
9	RI

3.2.14 HP (Combo audio jack (Headphone & Headset))

14

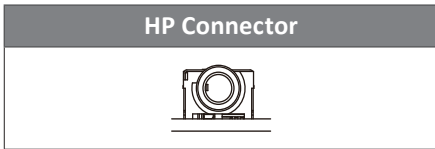
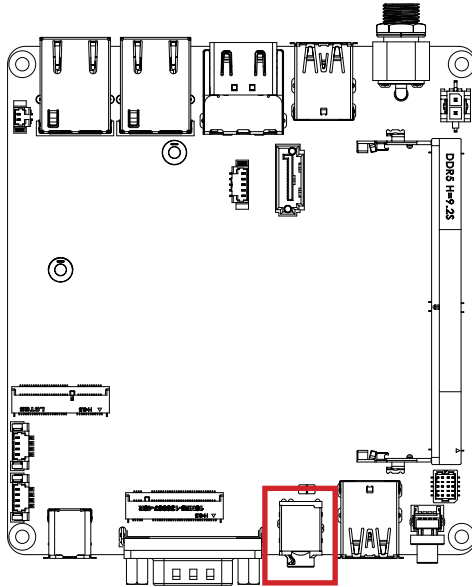

Connector PN	Vendor
2SJ3082-086111F	SINGATRON

Pin No.	Definition	Pin No.	Definition
1	HPOUT_L	4	MIC_IN_C
2	HPOUT_R	5	HP_JD
3	AGND	6	AGND

3.2.15 USB31_2 (USB 3.2 Gen 2x1 connector)

15

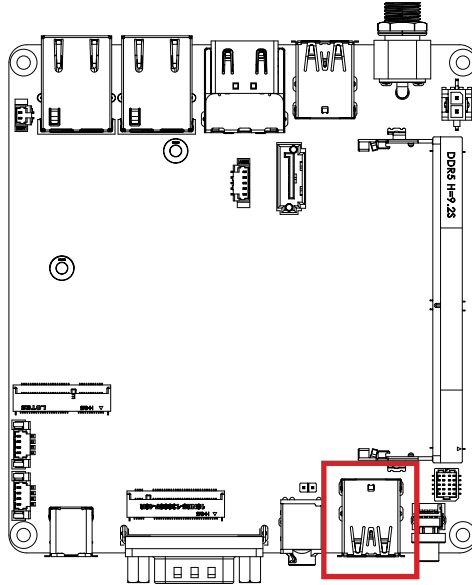

USB 3.2 Gen 2x1 connector

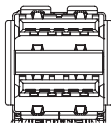

Connector PN

18-A5950-6A33-A

Vendor

TCONN

Pin No.	Definition	Pin No.	Definition
1	5V	10	5V
2	D1n	11	D0n
3	D1p	12	D0p
4	GND	13	GND
5	USB3_RX1n	14	USB3_RX2n
6	USB3_RX1p	15	USB3_RX2p
7	GND	16	GND
8	USB3_TX1n	17	USB3_TX2n
9	USB3_TX1p	18	USB3_TX2p

3.2.16 PWR_BUTTON (Power button)

16

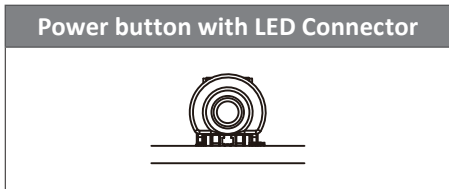
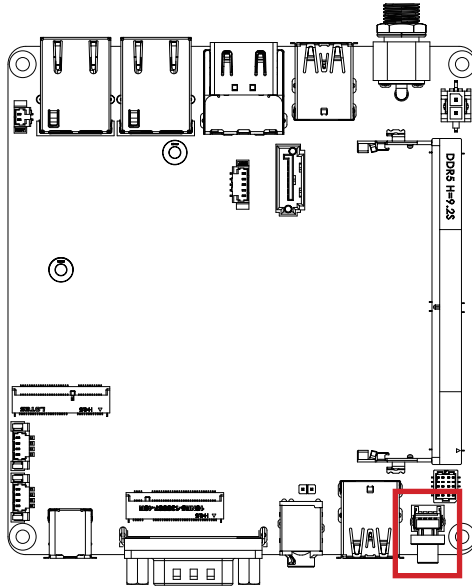

Connector PN	Vendor
TP6153TRML-5	HIGHLY

3.2.17 DC_IN1 (Screw type DC Jack connector)

17

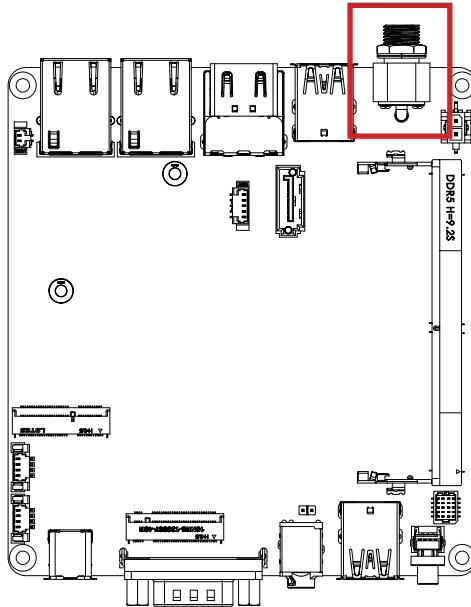

Screw Type DC Jack Connector

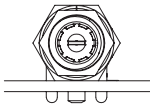

Connector PN

655-360-000

Vendor

SHEN-MING

3.2.18 USB31_1 (USB 3.2 Gen 2x1 connector)

18

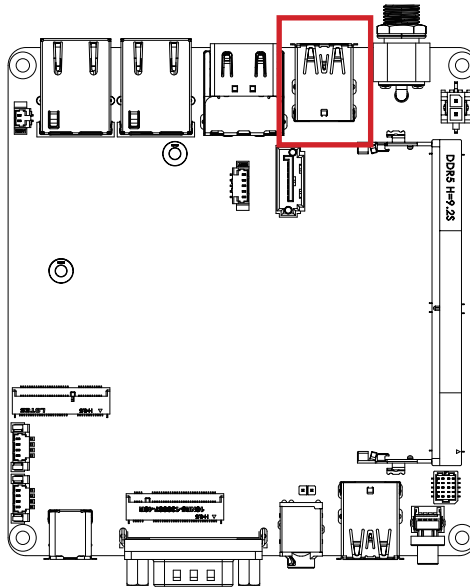

USB 3.2 Gen 2x1 connector

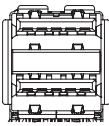

Connector PN

18-A5950-6A33-A

Vendor

TCONN

Pin No.	Definition	Pin No.	Definition
1	5V	10	5V
2	D1n	11	D0n
3	D1p	12	D0p
4	GND	13	GND
5	USB3_RX1n	14	USB3_RX2n
6	USB3_RX1p	15	USB3_RX2p
7	GND	16	GND
8	USB3_TX1n	17	USB3_TX2n
9	USB3_TX1p	18	USB3_TX2p

3.2.19 HDMI2_21 (HDMI connector)

19

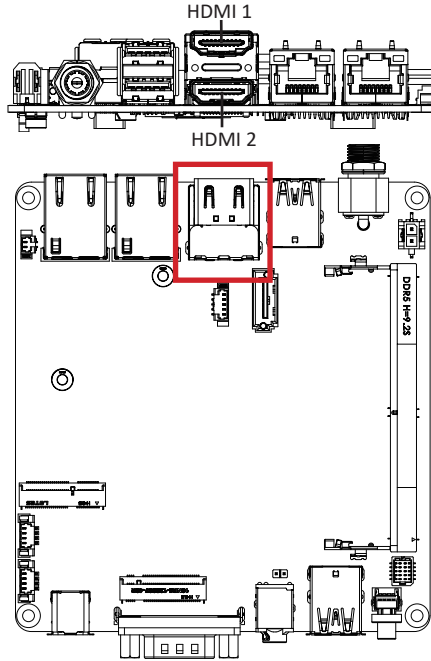

HDMI Connector

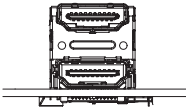

Connector PN	Vendor
QJ11191-DFB1-4F	FOXCONN

Pin No.	Definition	Pin No.	Definition
1	TX2p	11	GND
2	GND	12	CLKn
3	TX2n	13	NC
4	TX1p	14	NA
5	GND	15	DDC Clock
6	TX1n	16	DDC Data
7	TX0p	17	GND
8	GND	18	5V
9	TX0n	19	Hot Plug Detect
10	CLKp		

3.2.20 LAN1, LAN2 (LAN connector)

20

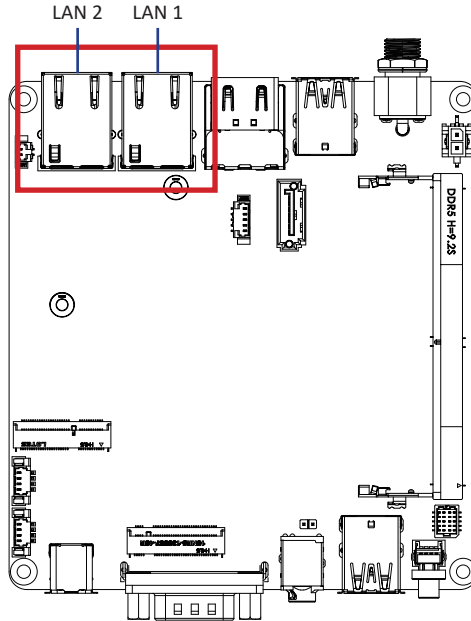

LAN Connector

Link / Activity LED Connection / Speed LED

Pin No.	Definition
1	TX1+
2	TX1-
3	TX2+
6	TX2-
4	TX3+
5	TX3-
7	TX4+
8	TX4-

State	Description
Orange On	1Gbps data rate
Green On	100Mbps data rate
Off	10Mbps data rate

Connector PN	Vendor
RT7-GB-0003	UDE

Chapter 4

Chapter 4 – BIOS

4.1 Introduction

BIOS (Basic input/output system) provides hardware detailed information and boot-up options, which include firmware to control, set-up and test all hardware settings. Therefore, BIOS is the communication bridge between OS/application software and hardware.

4.1.1 How to Entering into BIOS menu

Once the system is power on, press the key as soon as possible to access into BIOS Setup program.

4.1.2 Function Keys to setup in BIOS Setup program

Function keys	Description
→←	Select Screen
↑↓	Select Item
Enter	Execute command or enter the submenu
+	Increase the numeric value or make changes
—	Decrease the numeric value or make changes
F1	General Help
F2	Previous Values
F3	Load Optimized Defaults Settings
F4	Save changes & Exit the BIOS Setup program
ESC	Exit the BIOS Setup program

4.2 The Main Menu

The main menu shows the basic system information. Use arrow keys to move among the items.

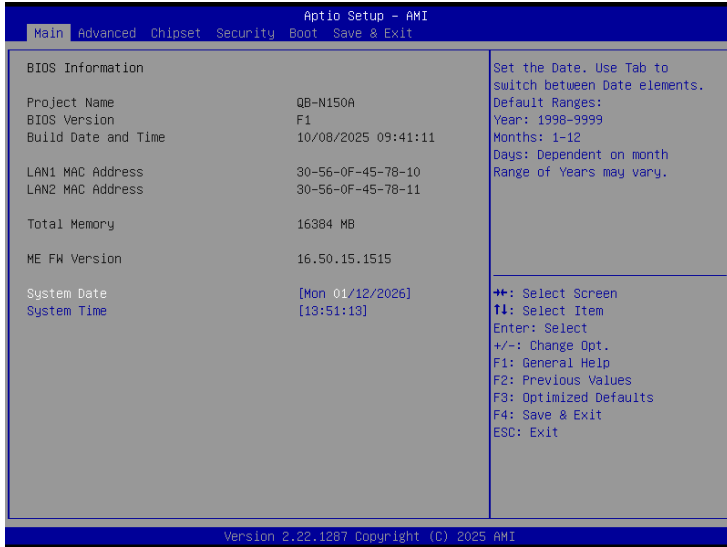

Items	Description
Project Name	Shows Project name information
BIOS Version	Shows the BIOS version of the system
Build Date and Time	Shows the Build Date and Time when the BIOS was created.
LAN1 MAC Address	Shows LAN1 MAC Address information
LAN2 MAC Address	Shows LAN2 MAC Address information
Total Memory	Shows the total memory size of the installed memory
ME FW version	Shows ME firmware version
System Date	Set the Date for the system (Format : Week - Month - Day - Year)
System Time	Set the time for the system (Format : Hour - Minute - Second)

4.3 Advanced

The Advanced menu is to configure the functions of hardware settings through submenu. Use arrow keys to move among the items, and press <Enter> to access into the related submenu.

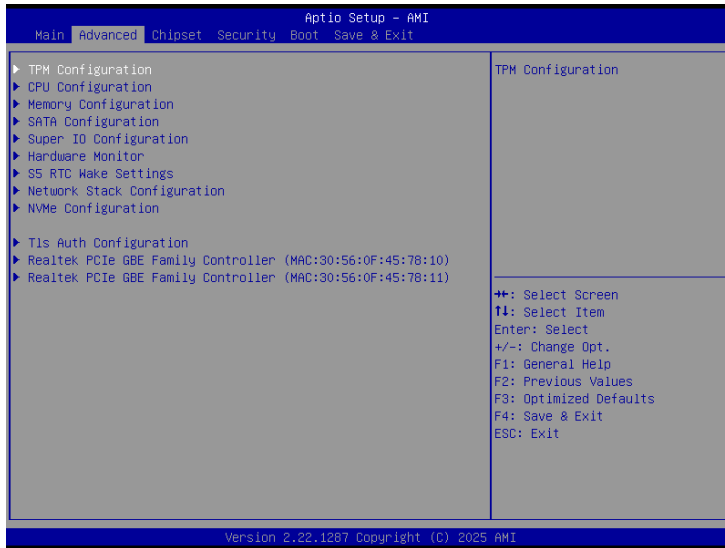

4.3.1 TPM Configuration

Use TPM Configuration submenu to choose TPM interface.

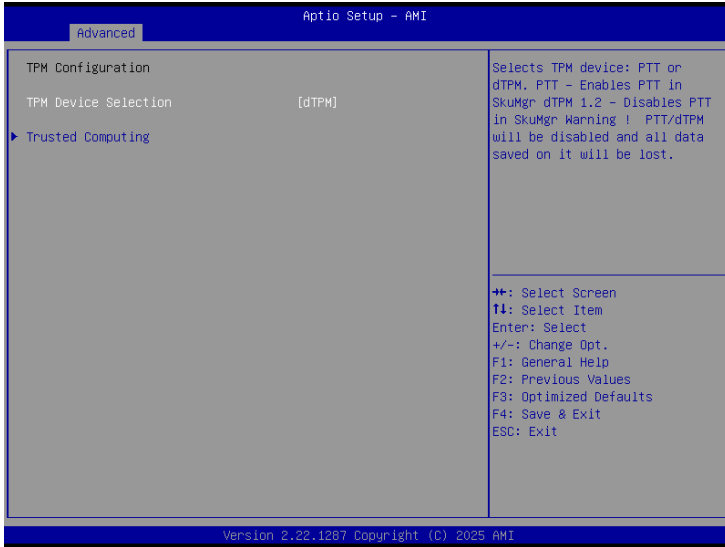

Item	Description
TPM Device Selection	PTT : Internal TPM dTPM : External TPM (When using External TPM module or having TPM chip on MB) (Default setting)

Trusted Computing : Shows TPM information, and TPM module configuration setting.



Item	Description
Security Device support	Enabled : Enables TPM feature (Default setting) Disabled : Disables TPM feature
Pending operation	None : No execution will be conducted (Default setting) TPM clear : Set to clear data on TPM

4.3.2 CPU Configuration

This submenu shows detailed CPU informations.

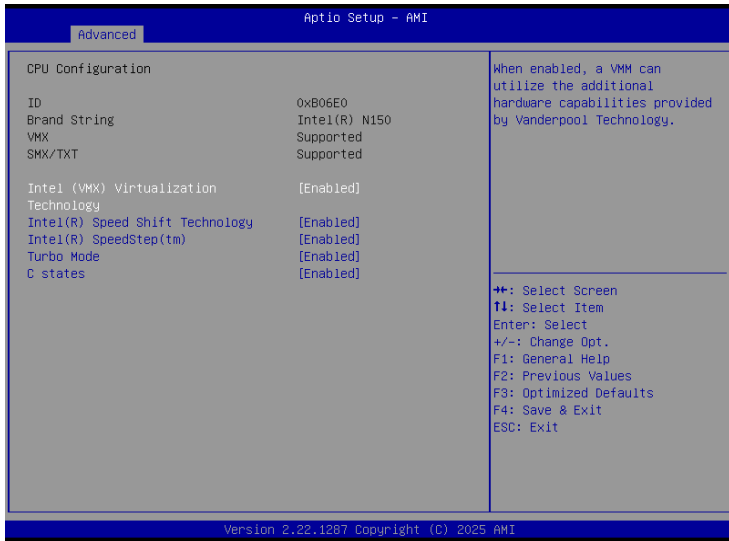

Item	Description
Intel (VMX) Virtualization Technology	Virtualization enhanced by Intel® Virtualization Technology will allow a platform to run multiple operating systems and applications in independent partitions. With virtualization, one computer system can function as multiple virtual systems. Enabled : Enables Intel Virtualization Technology (Default setting) Disabled : Disables Intel Virtualization Technology
Intel® Speed Shift Technology	Enabled : Enables Intel® Speed Shift Technology (Default setting) Disabled : Disables Intel® Speed Shift Technology
Intel® Speedstep™	Enabled : Enables Intel® Speedstep™ (Default setting) Disabled : Disables Intel® Speedstep™
Turbo Mode	Enabled : Enables Turbo Mode (Default setting) Disabled : Disables Turbo Mode
C states	Command CPU to enter into low power consumption mode when CPU is under idle mode. Enabled : Enables CPU C states function (Default setting) Disabled : Disables CPU C states function

4.3.3 Memory Configuration



Item	Description
In-Band ECC Support	Enable or Disable In-Band ECC Support function. Disabled : Disables In-Band ECC Support (Default setting) Enabled : Enables In-Band ECC Support

4.3.4 SATA Configuration

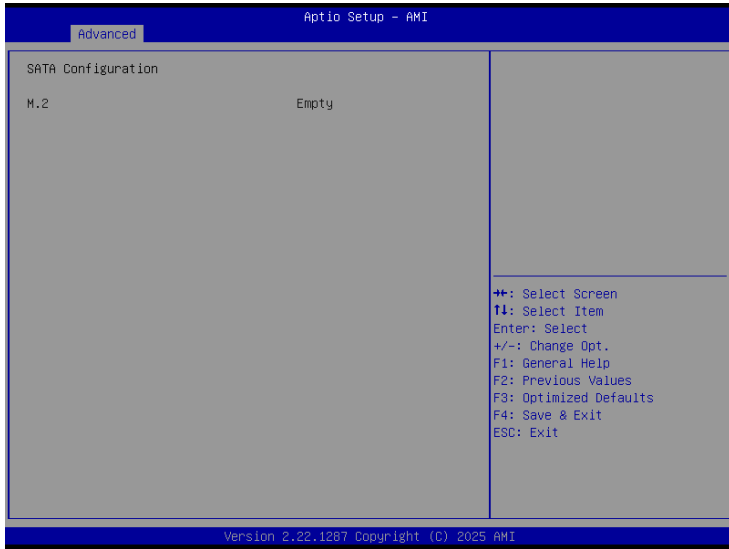

Item	Description
M.2	shows M.2 SATA interface SSD information

4.3.5 Super IO Configuration

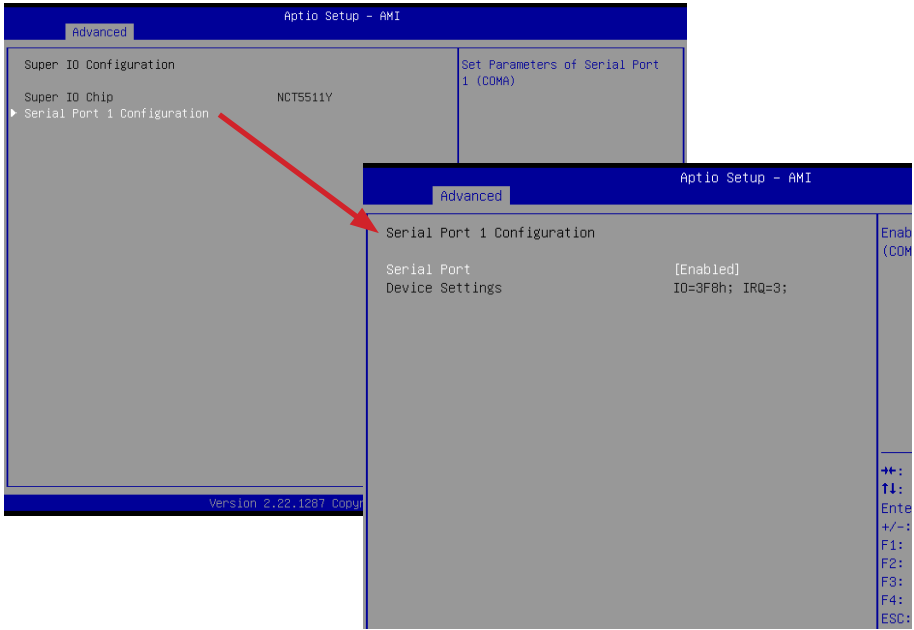

Item	Description
Super IO Chip	Shows Super I/O chip model
Serial Port 1 Configuration	Press [Enter] to configure advanced items : Enable or Disable Serial Port Enabled : Enables Serial Port function (Default setting) Disabled : Disables Serial Port function Device settings : Display the specified Serial Port base I/O address and IRQ

4.3.6 Hardware Monitor

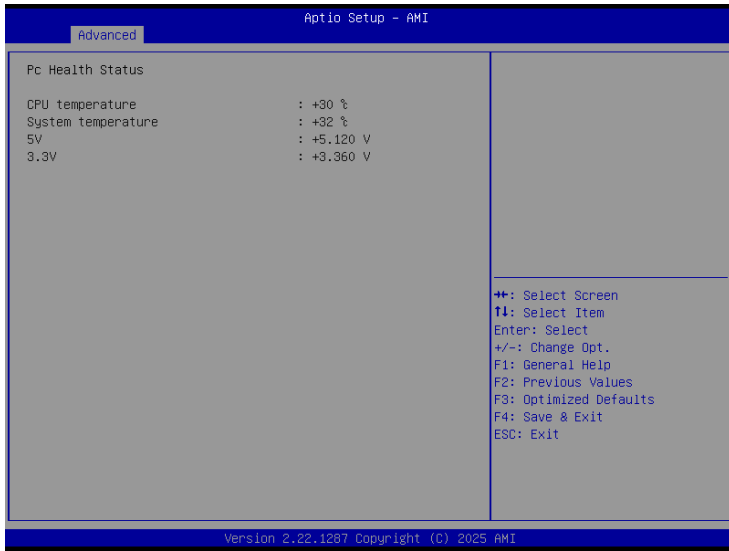

Item	Description
CPU Temperature	Shows current CPU temperature
System Temperature	Shows current system temperature

4.3.7 S5 RTC Wake Settings



Item	Description
Wake system from S5	Enable or Disable System to wake on a specific time. Disabled : Disables system to wake on a specific time (Default setting) Fixed Time : Enables system to wake on a specific time (Format : hr : min : sec)

4.3.8 Network Stack Configuration-1

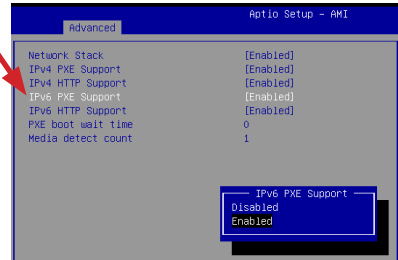
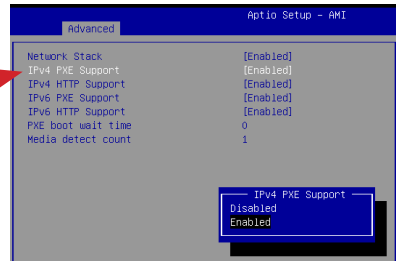
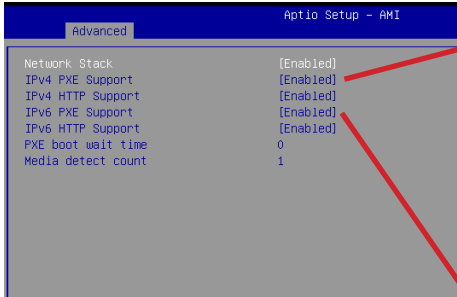
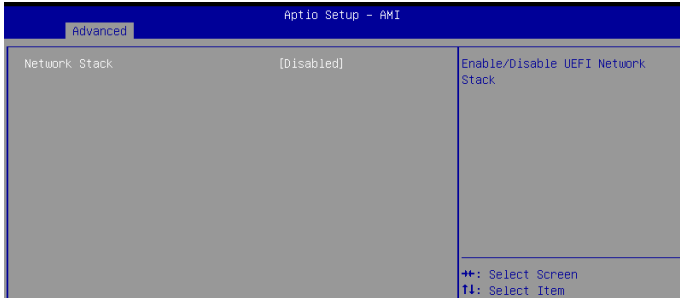

Item	Description
Network Stack	When system is power on, install LAN driver under UEFI mode Disabled : Disables UEFI Network Stack (Default setting) Enabled : Enables UEFI Network Stack
IPv4 PXE Support	When Network stack is enabled : Disabled : Disables Ipv4 PXE Support Enabled : Enables Ipv4 PXE Support (Default setting)
IPv6 PXE Support	When Network stack is enabled : Disabled : Disables Ipv6 PXE Support Enabled : Enables Ipv6 PXE Support (Default setting)

4.3.8 Network Stack Configuration-2

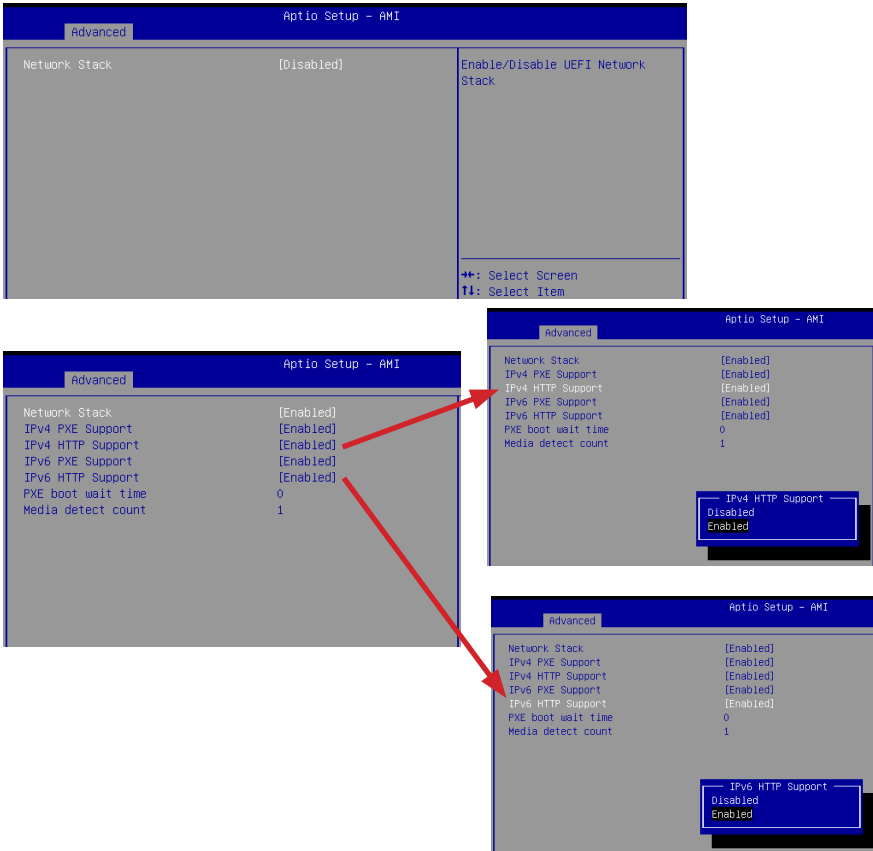

Item	Description
Network Stack	When system is power on, install LAN driver under UEFI mode Disabled : Disables UEFI Network Stack (Default setting) Enabled : Enables UEFI Network Stack
IPv4 HTTP Support	When Network stack is enabled : Disabled : Disables Ipv4 HTTP Support Enabled : Enables Ipv4 HTTP Support (Default setting)
IPv6 HTTP Support	When Network stack is enabled : Disabled : Disables Ipv6 HTTP Support Enabled : Enables Ipv6 HTTP Support (Default setting)

4.3.9 NVMe Configuration

NVMe Configuration shows information when your M.2 NVMe PCIe SSD is installed.

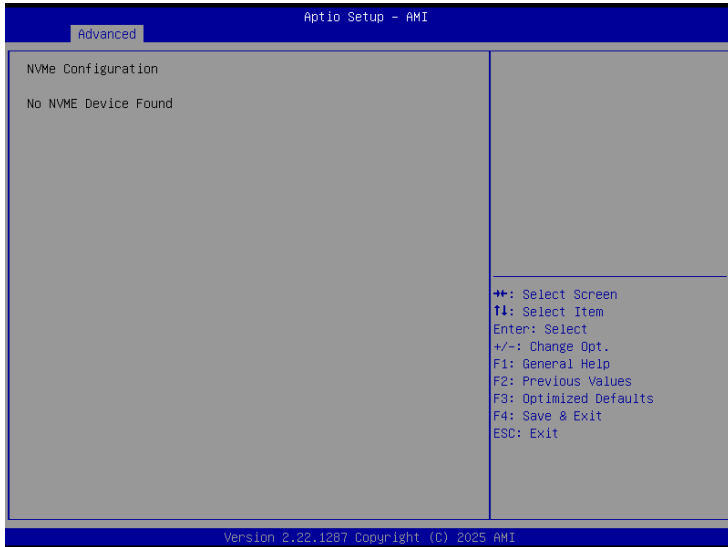

4.3.10 Tls Auth Configuration

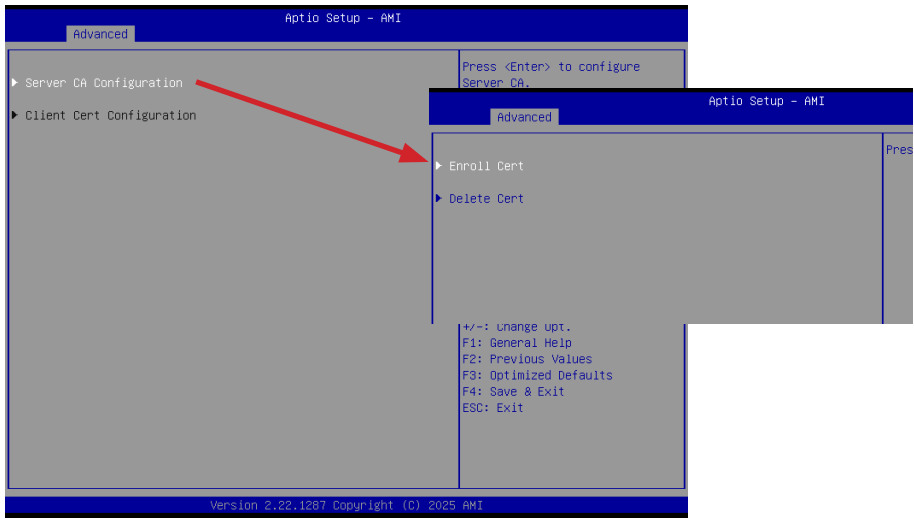

Item	Description
<p>Enroll Cert</p>	<p>Press [Enter] to configure advanced items :</p> <p>Server CA Configuration :</p> <p>Enroll Cert :</p> <ol style="list-style-type: none"> 1. Enroll Cert Using File 2. Cert GUID : Input digit character in 11111111-2222-3333-4444-1234567 890ab format. 3. Commit Changes and Exit 4. Discard Changes and Exit

4.3.11 Realtek PCIe GBE Family Controller (MAC:30:56:0F:45:78:10) (MAC address may varied based on different motherboard)

Shows Realtek Ethernet controller information

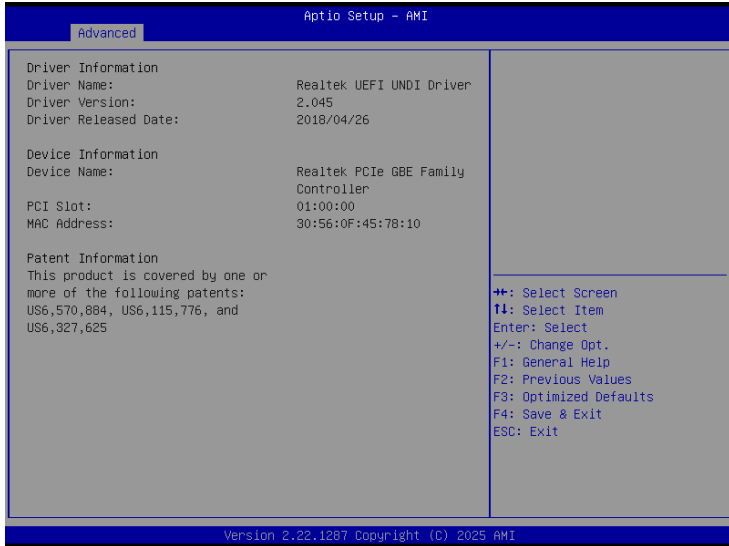

NOTE : MAC address may varied based on different motherboard

4.3.12 Realtek PCIe GBE Family Controller (MAC:30:56:0F:45:78:11) (MAC address may varied based on different motherboard)

Shows Realtek Ethernet controller information

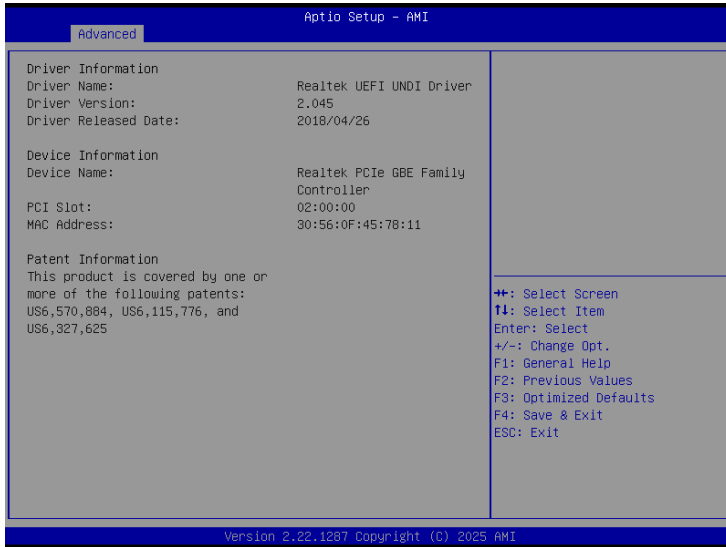

NOTE : MAC address may varied based on different motherboard

4.4 Chipset

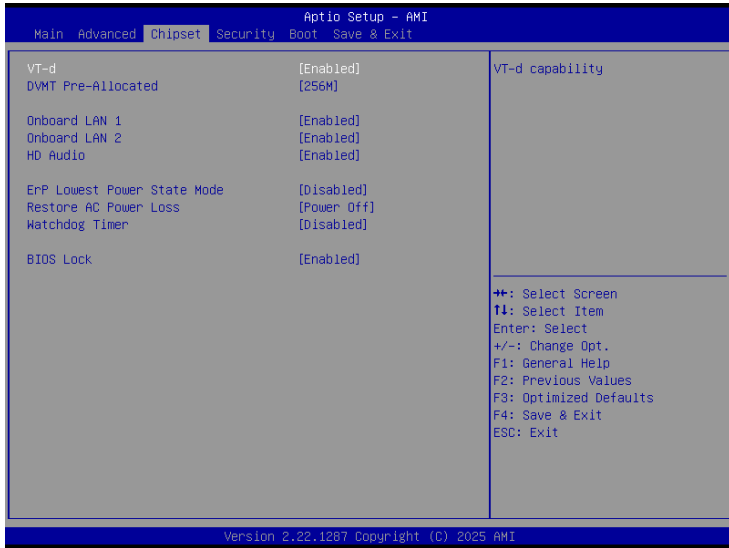

Item	Description
VT-d	Enabled : Enables VT-d function (Default setting) Disabled : Disables VT-d function
DVMT Pre-Allocated	Use DVMT Pre-Allocated to set the amount of system memory which is installed to the integrated graphics processor Option items : 32M , 64M, 128M, 256M (Default setting)
Onboard LAN1 Onboard LAN2	Enable/Disable onboard LAN controller Enabled : Enables onboard LAN controller (Default setting) Disabled : Disables onboard LAN controller
HD Audio	Enable/Disable onboard audio controller Enabled : Enables onboard audio controller (Default setting) Disabled : Disables onboard audio controller
ErP Lowest Power State Mode	Enable/Disable Enables ErP Lowest Power State Mode Enabled : Enables ErP Lowest Power State Mode Disabled : Disables ErP Lowest Power State Mode (Default setting)
Restore AC Power Loss	To set which option the system should returns if a sudden power loss occurred Power off : Do not power on when the power is back (Default setting) Power on : System power on when the power is back Last state : Restore the system to the state before power loss occurs
Watchdog Timer	Enable/Disable Watchdog Timer function Enabled : Enables Watchdog Timer function Disabled : Disabled Watchdog Timer function (Default setting)
BIOS Lock	Enable/Disable BIOS Lock function Enabled : Enables BIOS Lock function (Default setting) Disabled : Disabled BIOS Lock funtion

4.5 Security



Item	Description
Administrator Password	To set up Administrator's password Minimum length : 3 Maximum length : 20
User Password	To set up User's password Minimum length : 3 Maximum length : 20
Secure Boot	Press <Enter> to configure the advanced items



Item	Description
Secure Boot	Secure Boot requires all the applications that are running during the booting process to be pre-signed with valid digital certificates Enabled : Enables Secure Boot function Disabled : Disables Secure Boot function (Default setting)
Secure Boot Mode	Standard : Standard mode Custom : Custom mode (Default setting)
Restore Factory Keys	To restore factory settings Yes : Agree to restore factory settings No : Cancel to restore factory settings
Reset To Setup Mode	Yes : Agree to setup mode No : Cancel to setup mode
Key Management	Enables expert users to modify Secure boot policy variables without full authentication Press <Enter> to configure the advanced items

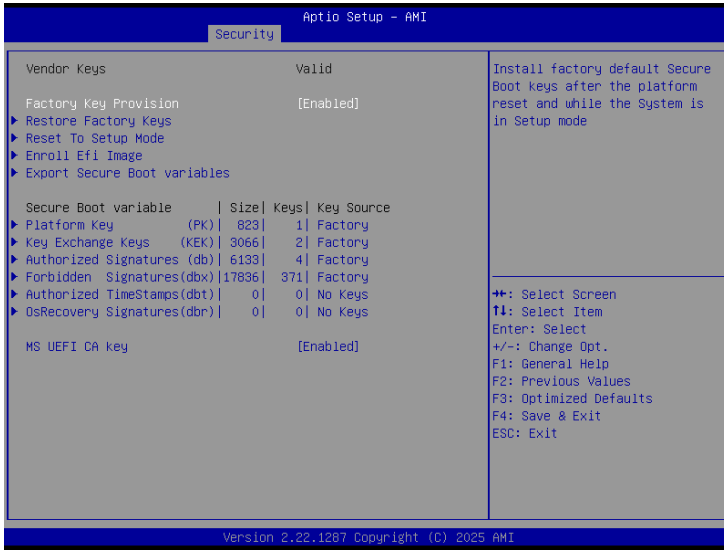

Item	Description
Factory Key Provision	Install factory default Secure Boot keys after the platform reset and while the system is in Setup mode Enabled : Enables Factory Key Provision (Default setting) Disabled : Disables Factory Key Provision
Restore Factory Keys	To restore factory settings
Reset To Setup Mode	Delete all Secure boot key databases from NVRAM
Enroll Efi Image	Allow the image to run in Secure Boot mode
Export Secure Boot variables	Copy NVRAM content of Secure Boot variables to files in a root folder on a file system device

Item	Description
Platform Key (PK)	These items allows you to enroll factory defaults or load Certificates from a file.
Key Exchange Keys (KEK)	
Authorized Signatures (db)	
Forbidden Signatures (dbx)	
Authorized TimeStamps (dbt)	
OsRecovery Signatures (dbr)	
MS UEFI CA key	Enabled : Enables MS UEFI CA Key (Default setting) Disabled : Disables MS UEFI CA Key

4.6 Boot

This Boot menu allows you to set/change system boot options

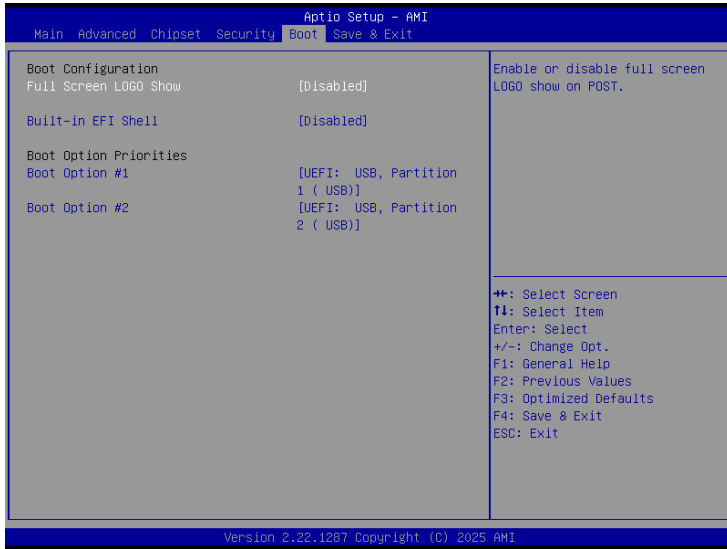

Item	Description
Full Screen LOGO Show	Enable/Disable full screen LOGO show on POST screen Enabled : Enables Full screen LOGO Show on POST screen Disabled : Disables Full screen LOGO Show on POST screen (Default setting)
Built-in EFI Shell	Enabled : Enables Built-in EFI Shell Disabled : Disables Built-in EFI Shell (Default setting)
Boot Option Priorities	Shows the information of the storage that be installed in the system Choose/set the boot priority

4.7 Save & Exit

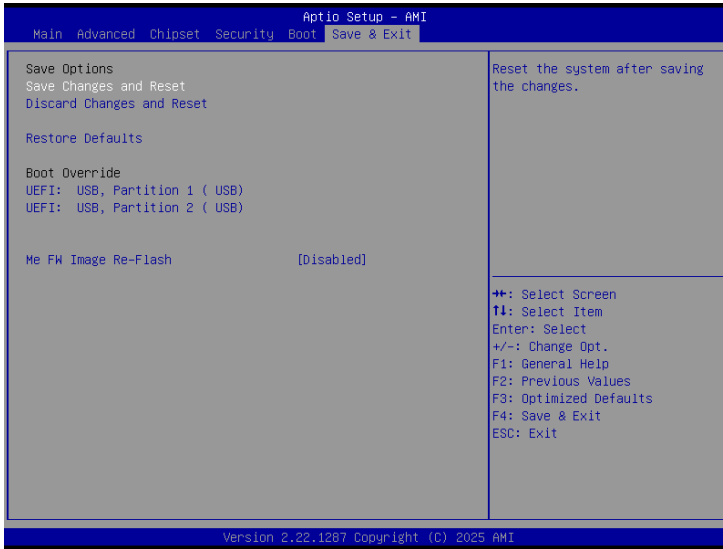

Item	Description
Save Changes and Reset	After configuring all the options that you wish to change, choose this option to save all the changes and reboot the system Yes : Agree to save and reset No : Cancel to save and reset
Discard Changes and Reset	Choose this option to reboot the system without saving any changes Yes : Agree to discard changes and reset No : Cancel to discard changes and reset
Restore Defaults	Restore/Load default values for all the setup options Yes : Agree to load optimized defaults No : Cancel to load optimized defaults
Me FW Image Re-Flash	Enable/Disable Me FW image re-flash function Enabled : Enables Me FW image re-flash function Disabled : Disables Me FW image re-flash function (Default setting)