

QBiX-KBLA7100H-A1

Industrial Embedded System Quick Start Guide

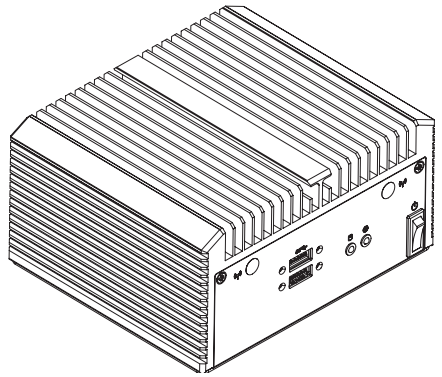
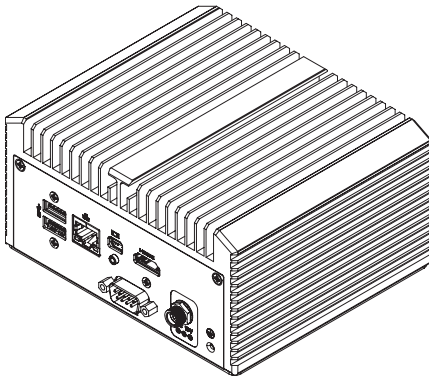

Copyright Notice

This document is copyrighted, 2019. All rights are reserved. The original manufacturer reserves the right to make improvements to the products described in this manual at any time without notice.

No part of this manual may be reproduced, copied, translated, or transmitted in any form or by any means without the prior written permission of the original manufacturer. Information provided in this manual is intended to be accurate and reliable. However, the original manufacturer assumes no responsibility for its use, or for any infringements upon the rights of third parties that may result from its use.

The material in this document is for product information only and is subject to change without notice. While reasonable efforts have been made in the preparation of this document to assure its accuracy, We assumes no liabilities resulting from errors or omissions in this document, or from the use of the information contained herein.

We reserves the right to make changes in the product design without notice to its users.

Acknowledgement

All other products' name or trademarks are properties of their respective owners.

- AMD is trademark of Advanced Micro Devices.
- Microsoft Windows is a registered trademark of Microsoft Corp.
- Intel, Pentium, Celeron, and Xeon are registered trademarks of Intel Corporation
- Core, Atom are trademarks of Intel Corporation
- ITE is a trademark of Integrated Technology Express, Inc.
- IBM, PC/AT, PS/2, and VGA are trademarks of International Business Machines Corporation.

All other product names or trademarks are properties of their respective owners.

Packing List

Before setting up your product, please make sure the following items have been shipped:

Item	Quantity
System kit	1
PSU ADP 19V 65W 100-240VAC (25EP2-10065L-F3S)	1
Power cord (3C x 18AWG SVT US) (25CP0-007001-Q0R)	1
CABLE SATA+Power (25CRA-010000-S9R)	1
SCREW I HEAD FOR 25HDD M3x8L (25KSG-130081-K1R)	4
THERMAL PAD HDD (25ST3-200052-T5R)	2
THERMAL PAD DRAM (25ST3-200051-T5R)	1
VESA_RS_BKT_KP (25HB1-TPL021-S8R)	1
VESA-SCREW-ASM (25KSD-000001-S4R)	1

If any of these items are missing or damaged, please contact your distributor or sales representative immediately.

About this Document

This User's Manual contains all the essential information, such as detailed descriptions and explanations on the product's hardware and software features (if any), its specifications, dimensions, jumper/connector settings/definitions, and driver installation instructions (if any), to facilitate users in setting up their product.

Users may refer to the website for the latest version of this document.

Safety Precautions

Please read the following safety instructions carefully. It is advised that you keep this manual for future references

1. All cautions and warnings on the device should be noted.
2. Make sure the power source matches the power rating of the device.
3. Position the power cord so that people cannot step on it. Do not place anything over the power cord.
4. Always completely disconnect the power before working on the system's hardware.
5. No connections should be made when the system is powered as a sudden rush of power may damage sensitive electronic components.
6. If the device is not to be used for a long time, disconnect it from the power supply to avoid damage by transient over-voltage.
7. Always disconnect this device from any AC supply before cleaning.
8. While cleaning, use a damp cloth instead of liquid or spray detergents.
9. Make sure the device is installed near a power outlet and is easily accessible.
10. Keep this device away from humidity.
11. Place the device on a solid surface during installation to prevent falls
12. Do not cover the openings on the device to ensure optimal heat dissipation.

13. Watch out for high temperatures when the system is running.
14. Do not touch the heat sink or heat spreader when the system is running
15. Never pour any liquid into the openings. This could cause fire or electric shock.
16. As most electronic components are sensitive to static electrical charge, be sure to ground yourself to prevent static charge when installing the internal components. Use a grounding wrist strap and contain all electronic components in any static-shielded containers.
17. If any of the following situations arises, please the contact our service personnel:
 - i. Damaged power cord or plug
 - ii. Liquid intrusion to the device
 - iii. Exposure to moisture
 - iv. Device is not working as expected or in a manner as described in this manual
 - v. The device is dropped or damaged
 - vi. Any obvious signs of damage displayed on the device
- 18. DO NOT LEAVE THIS DEVICE IN AN UNCONTROLLED ENVIRONMENT WITH TEMPERATURES BEYOND THE DEVICE'S PERMITTED STORAGE TEMPERATURES (SEE CHAPTER 1) TO PREVENT DAMAGE.**

FCC Statement

Warning!



This device complies with Part 15 FCC Rules. Operation is subject to the following two conditions: (1) this device may not cause harmful interference, and (2) this device must accept any interference received including interference that may cause undesired operation.

Caution:

There is a danger of explosion if the battery is incorrectly replaced. Replace only with the same or equivalent type recommended by the manufacturer. Dispose of used batteries according to the manufacturer's instructions and your local government's recycling or disposal directives.

Attention:

Il y a un risque d'explosion si la batterie est remplacée de façon incorrecte. Ne la remplacer qu'avec le même modèle ou équivalent recommandé par le constructeur. Recycler les batteries usées en accord avec les instructions du fabricant et les directives gouvernementales de recyclage.

Table Contents

Industrial Embedded System	1
Quick Start Guide	1
Copyright Notice	2
Acknowledgement	3
Packing List.....	4
About this Document	5
Safety Precautions	6
FCC Statement.....	8
Chapter 1 - Product Specifications	11
1.1 Specifications	13
Chapter 2 – Industrial Embedded System Kit	15
2.1 Dimension	16
2.2 Getting Familiar with Your Unit.....	17
2.3 C) Wireless Module : How to safely install the Module (Wireless Module inclusion may vary based on local distribution)	19
2.4 B) Memory Installation: DDR4 SO-DIMM	20
2.5 Antenna Installation (Antenna inclusion may vary based on local distribution)	21
2.6 DB9 COM Pin Define	22
2.7 Safety and Regulatory Information.....	22

Chapter 3 – 10” x 10” Motherboard Hardware Information

23

- 3.1 Jumpers and Connectors 24
 - 3.2.1 BATTERY (Battery cable connector)..... 27
 - 3.2.2 CPU FAN (CPU FAN connector) 28
 - 3.2.3 EDP (Embedded Display Port Connector)..... 29
 - 3.2.4 ATX IN 30
 - 3.2.5 BKL_SEL (Back light brightness control connector) 31
 - 3.2.6 F_PANEL (Front panel header) 32
 - 3.2.7 F_USB3_1 (Front USB 3.2 Gen 1) 33
 - 3.2.8 COM (Serial port header)..... 34
 - 3.2.9 F_USB2_1, F_USB2_2 (USB 2.0 header) 35
 - 3.2.10 SATA_PWR_0 (SATA 6Gb/s power connector)..... 36
 - 3.2.11 SATA0 (SATA 6Gb/s connector) 37

Chapter 1

Chapter 1 - Product Specifications

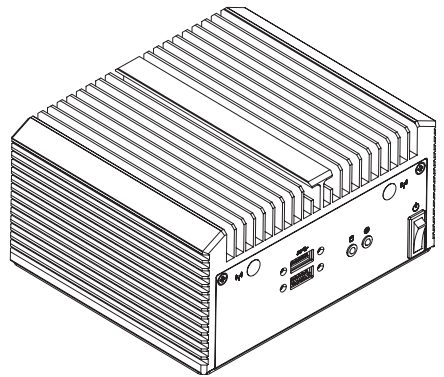
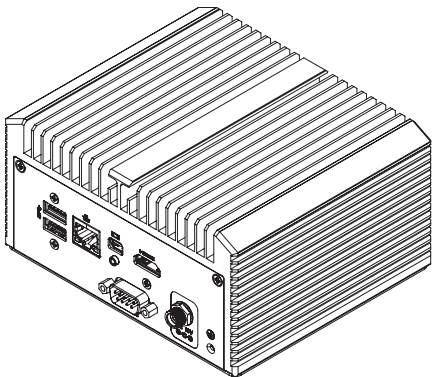

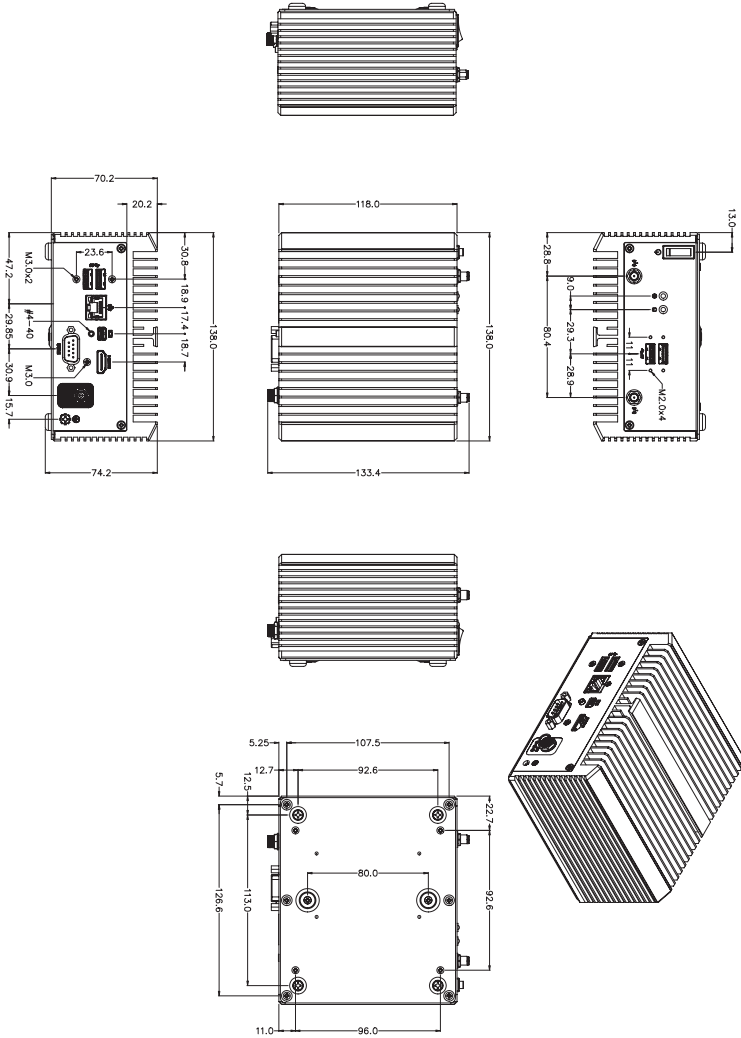

1.1 Specifications

System	QBiX-KBLA7100H-A1 (GB-CKAA-SI)
Dimension	System Size : 138W x 118D x 74.2H (mm)
CPU	Intel® Core™ i3-7100U Processor 14nm, 2 cores, 4 threads, up to 2.40 GHz TDP 15W 3 MB SmartCache
Chipset	SoC
Memory	2 x DDR4 SO-DIMM socket, Max. Capacity 32 GB Support Dual Channel DDR4 2133 MHz memory modules
Ethernet	1 x GbE LAN port (Intel® i219V)
Graphic support	Integrated Graphics Processor - Intel® HD Graphics 620 support 1 x HDMI2.0 port, supporting a maximum resolution of 4096 x 2160 @60Hz 1 x mini DP port, supporting a maximum resolution of 4096 x 2160 @60Hz
Audio	Intel® integrated Audio
Storage	1 x 2.5" HDD/SSD (SATA 6Gb/s)
Expansion Slots	1 x 2280 M.2 M-Key (PCIe x4, SATA 6Gb/s) 1 x 2230 M.2 E-Key (WiFi/BT)
Front I/O	2 x USB 3.2 Gen 1 1 x Power switch 2 x External Antenna (optional) 1 x HDD LED 1 x Power LED
Rear I/O	1 x RJ45 LAN Port 2 x USB 3.2 Gen 1 1 x HDMI 1 x Mini Display Port 1 x COM Port (RS-232) 1 x Screw type DC Jack
Side I/O	—
Power	DC 12~24V Full Range (Adapter 19V/65W)

System	QBiX-KBLA7100H-A1 (GB-CKAA-SI)
Operation temperature	Operating temperature: 0°C to 50°C Operating humidity: 0-90% (non-condensing) Non-operating temperature: -40°C to 85°C Non-operating humidity: 0%-95% (non-condensing) Use wide temperature range memory and storage
Vibration During Operation	Operation: IEC 60068-2-64, 5 Grms, random, 5 ~ 500 Hz, 1 hr / Per Axis, With SSD Non-operation: IEC 60068-2-6, 2 G, Sine, 10 ~ 500 Hz, 1 Oct/ min, 1 hr / Per Axis
Shock During Operation	Operation: IEC 60068-2-27, 50 G, half sine, 11 ms duration, With SSD
Packaging Content	Box Packing Capacity: 6pcs Carton size: 416x409x296(mm) Content: POWER CORD 3Cx18AWG SVT US x 1 (25CP0-007001-Q0R) PSU ADP 19V 65W 100-240VAC x 1 (25EP2-10065L-F3S) VESA_RS_BKT_KP x 1 (25HB1-TPL021-S8R) VESA-SCREW-ASM x 1 (25KSD-000001-S4R) SCREW I HEAD FOR 25HDD M3x8L x 4 (25KSG-130081-K1R) THERMAL PAD HDD x 2 (25ST3-200052-T5R) THERMAL PAD DRAM2 x 1 (25ST3-200051-T5R) CABLE SATA+Power x 1 (25CRA-010000-S9R)
Order Information	System: : 6BCKAAMR-SI

Chapter 2

Chapter 2 – Industrial Embedded System Kit

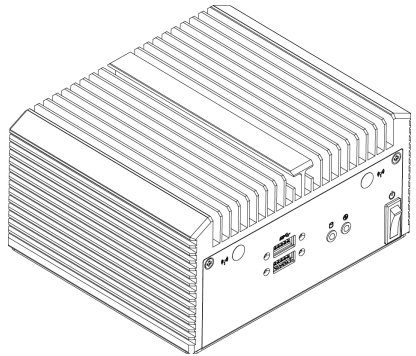
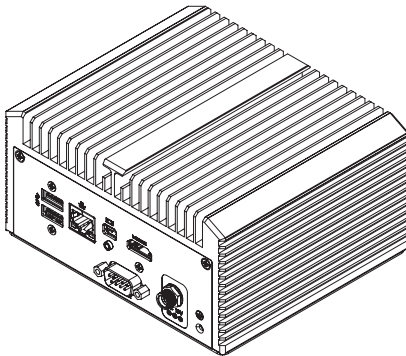

2.1 Dimension

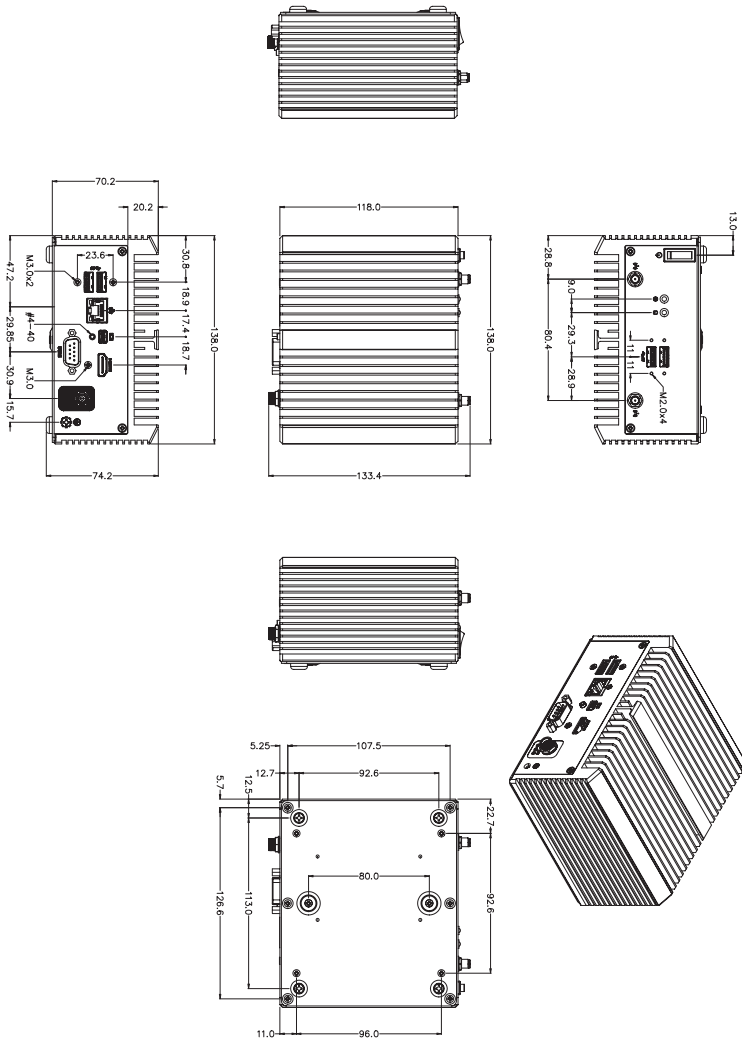

2.2 Getting Familiar with Your Unit

[Front Side]

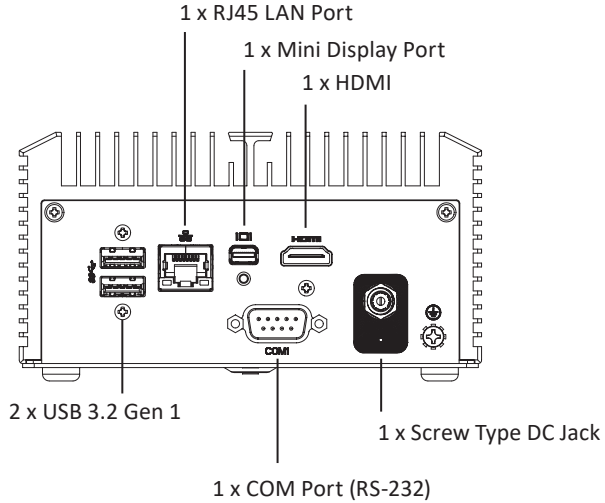

[Rear Side]

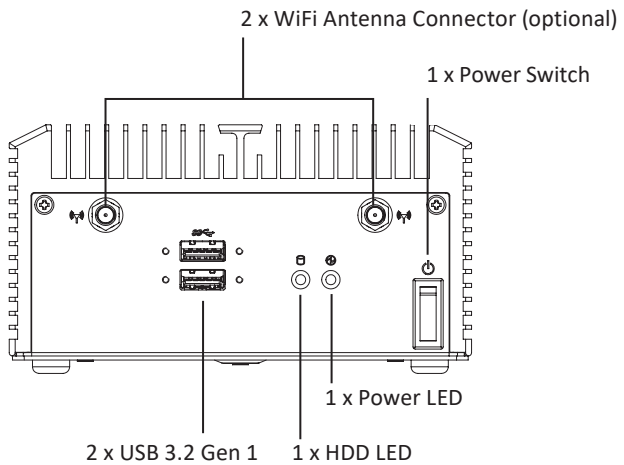

[Install]

- * Before opening the case, make sure to unplug the power cord.
- * 打開機殼前，請確實移除電源。
- * Before Connecting the power, make sure to fasten the case securely.
- * 接上電源前，請確實將機殼完整鎖附。

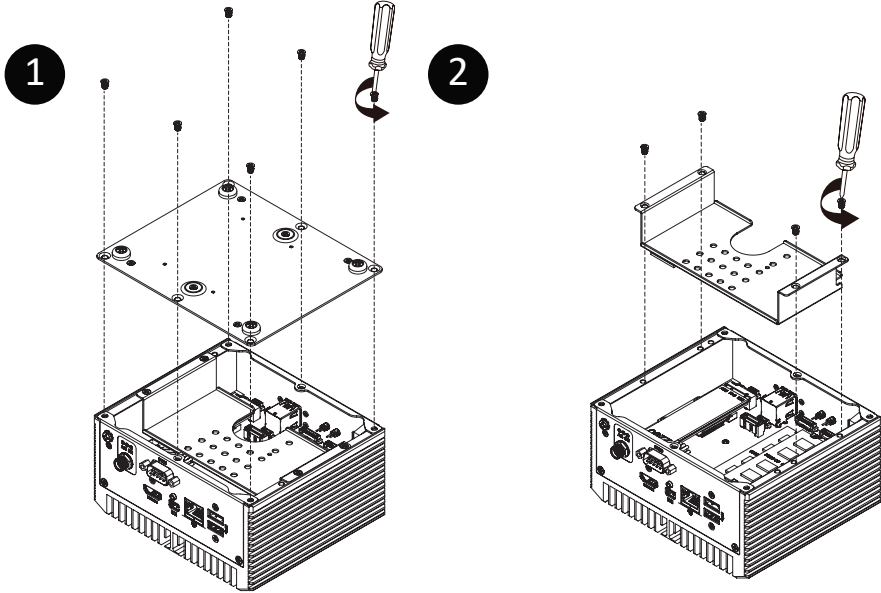

[Bottom PCB Side]

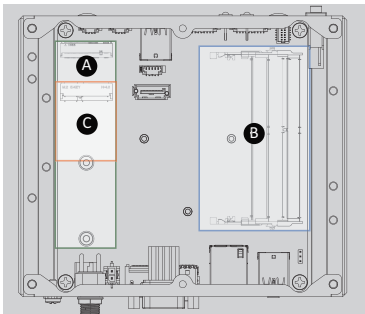

Information	
A	M.2 M-Key slot (Supports NGFF-2280 SATA 6 Gb/s, PCIeX4)
B	DDR4 2400 MHz SO-DIMM Slot x 2
C	M.2 E-Key slot (Support NGFF-2230 WiFi/ BT)

2.3 C) Wireless Module : How to safely install the Module (Wireless Module inclusion may vary based on local distribution)

1

Carefully insert the wireless module into the M.2 slot

小心地將無線模組安裝於M.2插槽中。

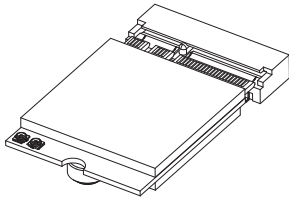
**2**

Lock the screw in the middle.

鎖入固定於無線模組中央頂端的螺絲。

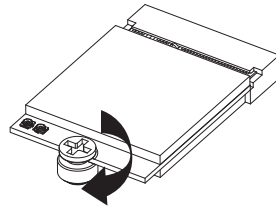
**3**

Install the antenna on the left side of the connection wireless module down.

向下安裝連結於無線模組左側頂端天線。

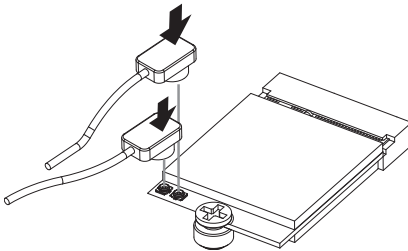

2.4 B) Memory Installation: DDR4 SO-DIMM

1

Carefully insert SO-DIMM memory modules.

小心地由下至上將 SO-DIMM 記憶體安裝於記憶體插槽。

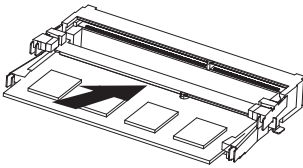

2

Push down until the modules click into place.

當記憶體固定於插槽後，再輕輕下壓至定點。

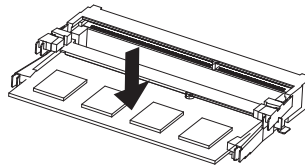

3

Carefully insert SO-DIMM memory modules.

安裝下層記憶體後，重覆前述動作安裝上層記憶體。

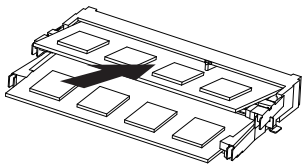

4

Push down until the modules click into place.

當記憶體固定於插槽後，再輕輕下壓至定點。

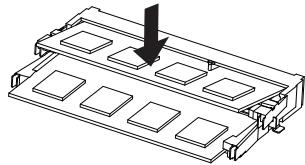

2.5 Antenna Installation (Antenna inclusion may vary based on local distribution)

1

Carefully insert the antennas into the connectors.
小心地將天線插入天線插孔中。

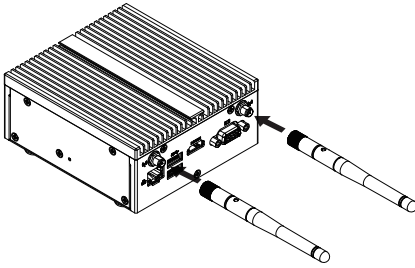
**2**

Turn the antennas clockwise until they are completely secure on the connectors.
握住天線接頭底端，按順時針方向將天線旋入插孔中牢牢固定。

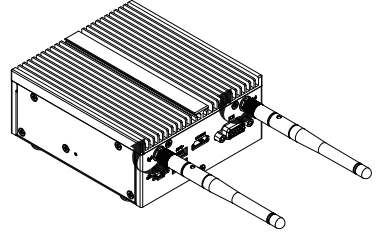
**3**

Flip up the antenna heads so that they are perpendicular to the machine.
栓緊後請將天線拉起朝上呈垂直狀。

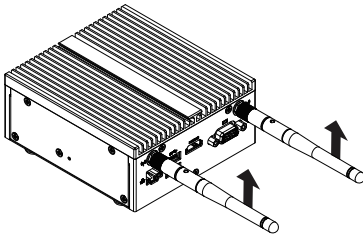

2.6 DB9 COM Pin Define

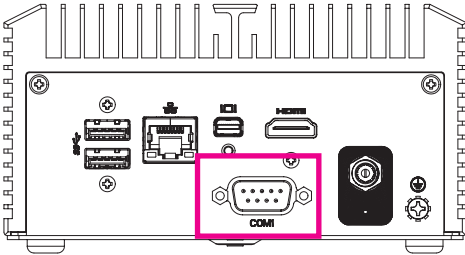

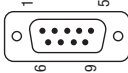
DB9 COM	
	
25CF8-120620-S9R	
Pin No.	Pin Define
1	DCD
2	RXD
3	TXD
4	DTR
5	GND
6	DSR
7	RTS
8	CTS
9	RI

2.7 Safety and Regulatory Information

Risk of explosion if the battery is replaced with an incorrect type. Batteries should be recycled where possible.

Disposal of used Batteries must be in accordance with local environmental regulations.

Failure to use the included Power Adapter may violate regulatory compliance and may expose the user to safety hazards.



At the end of its serviceable life, this product should not be treated as household or general waste. It should be handed over to the applicable collection point for the recycling of electrical and electronic equipment, or returned to the supplier for disposal.

Chapter 3

Chapter 3 – 10" x 10" Motherboard Hardware Information

3.1 Jumpers and Connectors

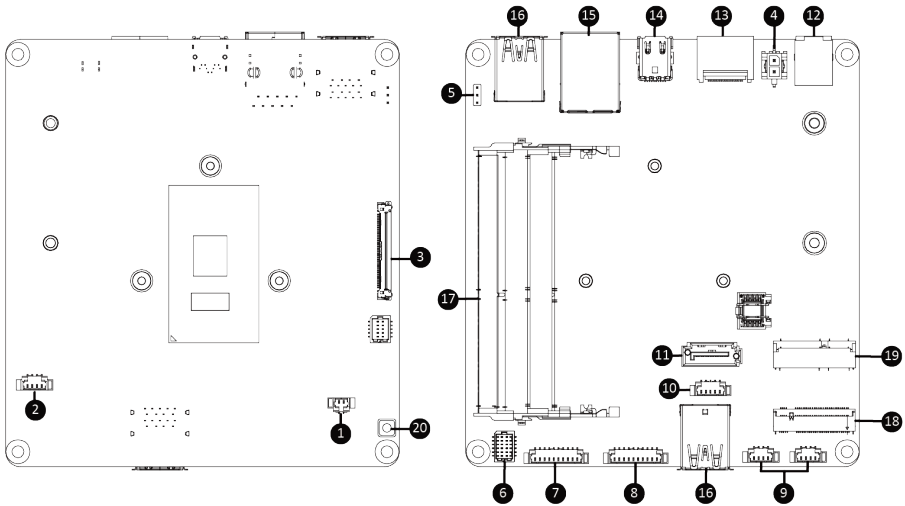

No	Code	Description
1	BATTERY	Battery cable connector
2	CPU_FAN	CPU FAN connector
3	EDP	Embedded Display Port Connector
4	ATX_IN	1 x 2 pin DC-IN Connector
5	BKL_SEL	Back light brightness control connector
6	F_PANEL	Front panel connector
7	F_USB3_1	Front USB 3.2 Gen 1
8	COM	Serial port connector
9	F_USB2_1 F_USB2_2	USB 2.0 header
10	SATA_PWR_0	SATA 6Gb/s power connector
11	SATA0	SATA 6Gb/s connector
12	DC_IN	DC in Jack connector
13	HDMI20	HDMI connector

No	Code	Description
14	MDP	Mini Display connector
15	LAN	RJ45 connector
16	USB3_1	USB 3.2 Gen 1
17	SODIMM1 SODIMM2	DDR4 SO-DIMM Slot
18	M2M	M.2 slot (Support NGFF-2280 SATA/PCIeX4)
19	M2E	M.2 slot (Support NGFF-2230 WiFi/BT)

3.2.1 BATTERY (Battery cable connector)

1

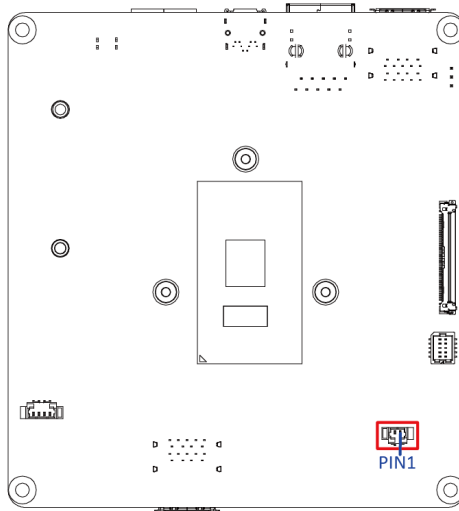

Battery Cable Connector

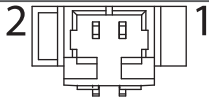

Connector PN

85205-0270L
A1250WV-S-02PC

Vendor

ACES
JOINT-TECH

Pin No. Definition

1	3.3V
2	GND

3.2.2 CPU FAN (CPU FAN connector)

2

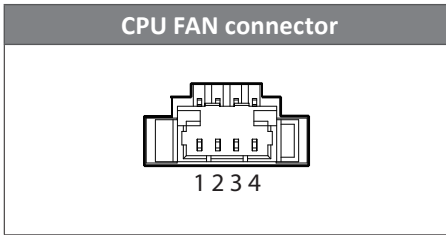
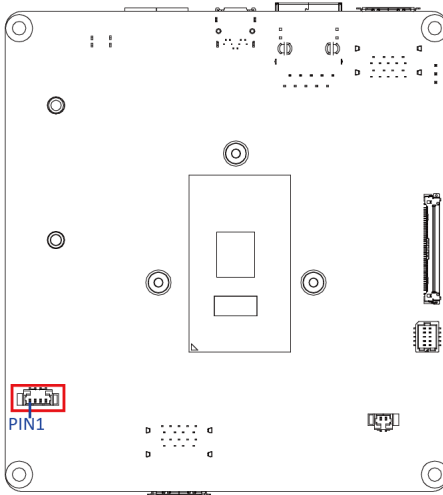

Connector PN	Vendor
85205-0470N	ACES
A1250WV-S-04PC	JOINT-TECH

Pin No.	Definition
1	GND
2	+V5S
3	TACH_PWRFAN1
4	PWM_PWMFAN1

3.2.3 EDP (Embedded Display Port Connector)

3

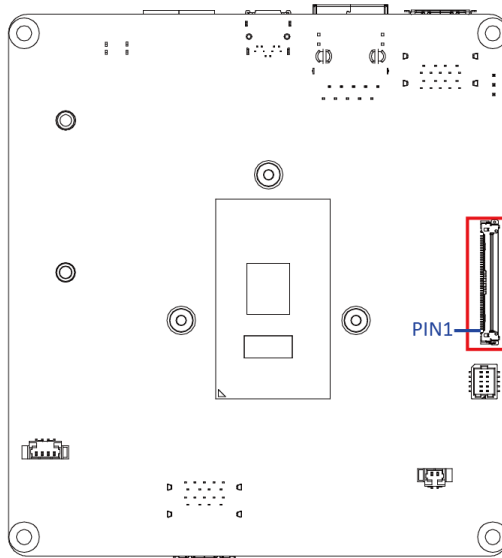

Embedded Display Port connector

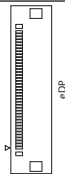

Pin No.	Definition	Pin No.	Definition
1	NC	21	+LCD_VCC (5V)
2	GND	22	NC
3	EDP_LANN3	23	GND
4	EDP_LANP3	24	GND
5	GND	25	GND
6	EDP_LANN2	26	GND
7	EDP_LANP2	27	EDP_HPDI_3V3
8	GND	28	GND
9	EDP_LANN1	29	GND
10	EDP_LANP1	30	GND
11	GND	31	GND
12	EDP_LANNO	32	EDP_BKLTEN_3V3

Pin No.	Definition	Pin No.	Definition
13	EDP_LANP0	33	EDP_BKLCTL_3V3
14	GND	34	NC
15	EDP_AUX_C_DP	35	NC
16	EDP_AUX_C_DN	36	+BL_PWR (10V or DCIN)
17	GND	37	+BL_PWR (10V or DCIN)
18	+LCD_VCC (5V)	38	+BL_PWR (10V or DCIN)
19	+LCD_VCC (5V)	39	+BL_PWR (10V or DCIN)
20	+LCD_VCC (5V)	40	NC

Note: Please ensure pin 8 is connected to Ground.

Connector PN	Vendor
20455-040E-12	I-PEX

3.2.4 ATX IN

4

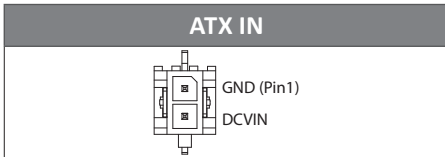
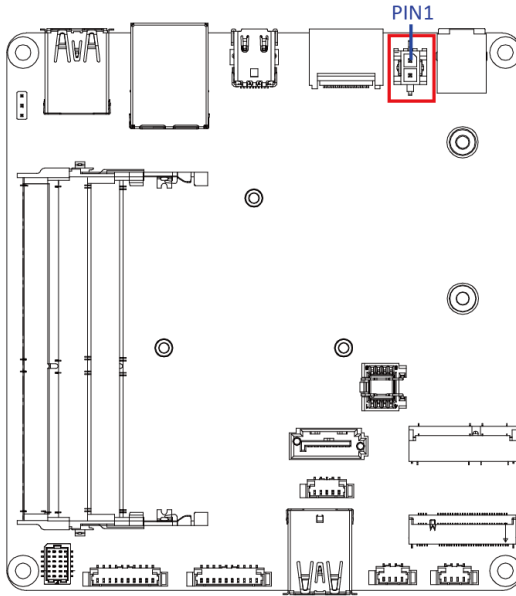

Connector PN	Vendor
99-01740-B004-A	TCONN

Pin No.	Definition
1	GND
2	DCVIN

3.2.5 BKL_SEL (Back light brightness control connector)

5

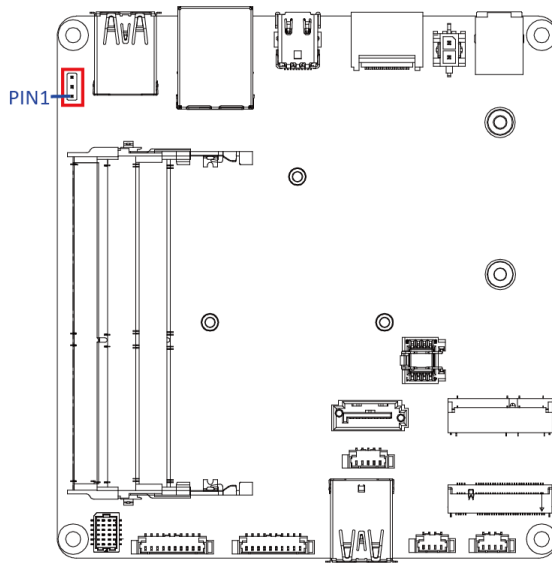

Back light brightness control connector

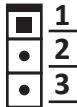

Pin No.	Definition
1	VIN
2	+BL_PWR_Q
3	VIN_10V

Connector PN	Vendor
222-96-03GBE1	PINREX
PH03N33BAAA00	HORNGTONG

Jumper	
DCIN(12V-24V)	1-2
10V Fix	2-3 (Default)

3.2.6 F_PANEL (Front panel header)

6

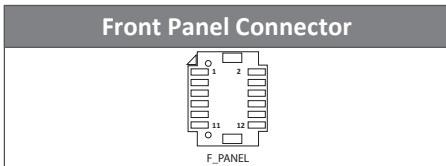
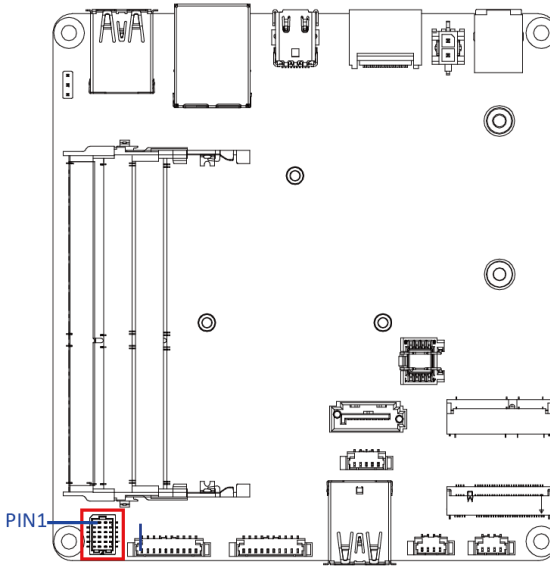

Connector PN	Vendor
87216-1206-06	ACES

Pin No.	Definition
1	SATA_LED_P
2	MPD_+
3	GND (SATA_LEN_N)
4	MPD-
5	GND
6	-PANSHW (Power BTN)
7	PMU_RSTBTN_N (Reset BTN)
8	GND
9	+V5S
10	+V3.3A
11	+V5A
12	NC

3.2.7 F_USB3_1 (Front USB 3.2 Gen 1)

7

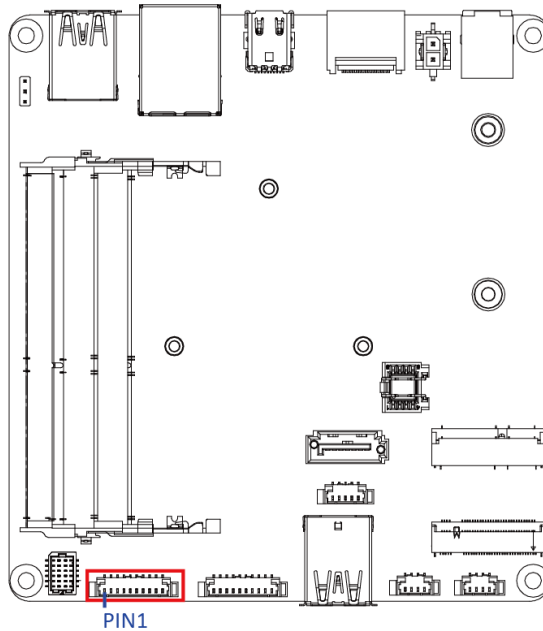

USB 3.2 Gen 1

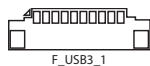

F_USB3_1

Pin No.	Definition
1	VCC
2	D-
3	D+
4	GND
5	TXN
6	TXP
7	GND
8	RXN
9	RXP
10	NC

Connector PN	Vendor
DF13C-10P-1.25V(51)	HRS
85205-10701	ACES

3.2.8 COM (Serial port header)

8

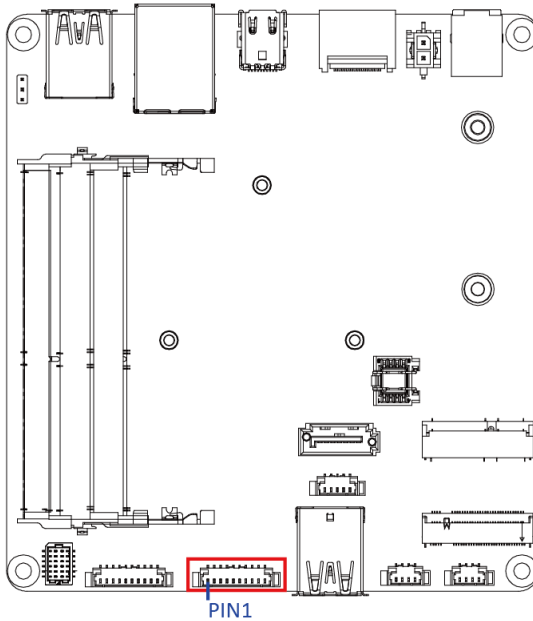

Serial Port Cable Connector

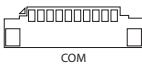

Connector PN

DF13C-10P-1.25V(51)

85205-10701

Vendor

HRS

ACES

Pin No.	Definition
1	NDCDA-
2	NRXDA-
3	NTXDA-
4	NDTRA-
5	GND
6	NDSRA-
7	NRTSA-
8	NCTSA-
9	NRIA-
10	NC

3.2.9 F_USB2_1, F_USB2_2 (USB 2.0 header)

7

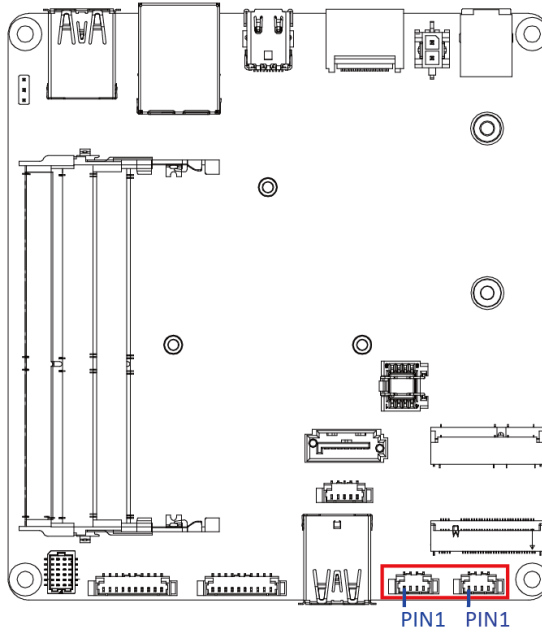

USB 2.0 Header

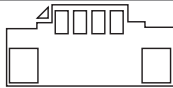

F_USB2.0

Pin No.	Definition
1	FUSEVCC3
2	USBN5_C
3	USBP5_C
4	GND

Connector PN

A1250WV-S-
04PNLBT1T00L

50273-0047N-001

Vendor

JOINT-TECH

ACES

3.2.10 SATA_PWR_0 (SATA 6Gb/s power connector)

10

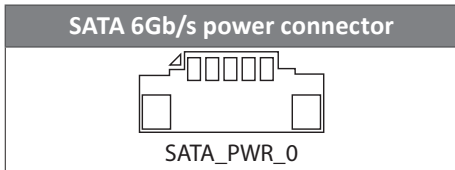
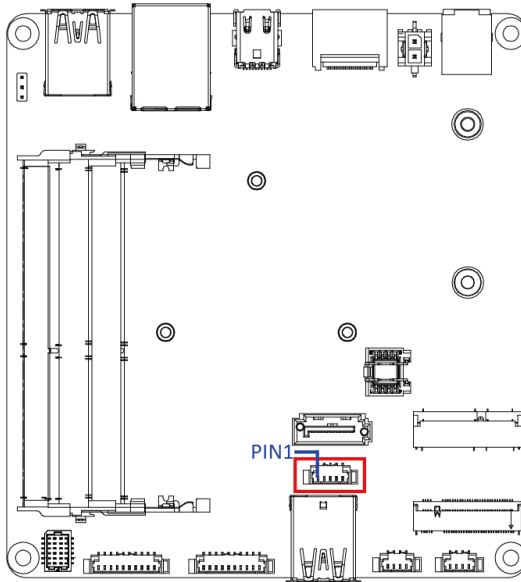

Connector PN	Vendor
85205-0570N	ACES
CI4405M1VRP-LF	CVILUX

Pin No.	Definition
1	+V5S
2	+V5S
3	+V3.3S
4	GND
5	GND

3.2.11 SATA0 (SATA 6Gb/s connector)

11

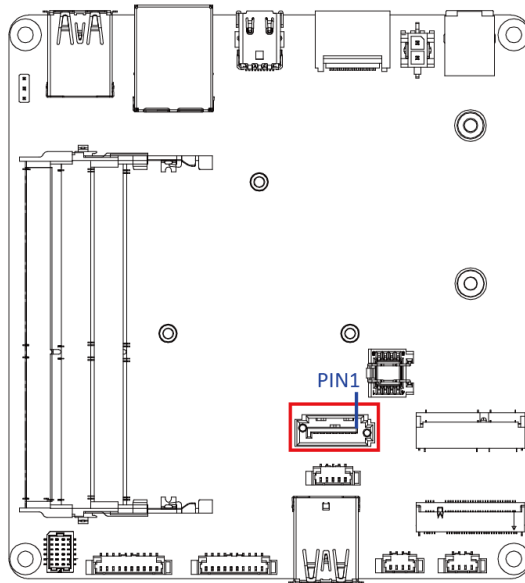

SATA 6Gb/s power connector

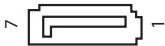

Connector PN

WATF-07DBLBA1UW

Vendor

WINWIN

Pin No.	Definition
1	GND
2	TXP
3	TXN
4	GND
5	RXN
6	RXP
7	GND