

QBiX-WP-APLA3940H-A1 (QW-3940A-SI)

QBiX-WP Waterproof Industrial Embedded System
Quick Start Guide

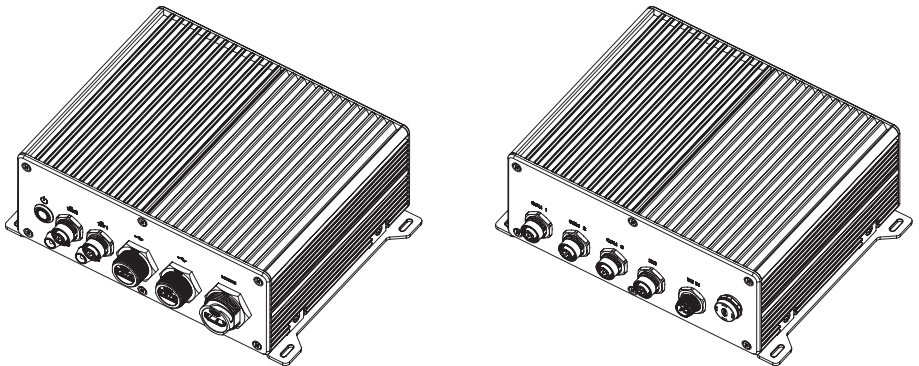

Copyright Notice

This document is copyrighted, 2019. All rights are reserved. The original manufacturer reserves the right to make improvements to the products described in this manual at any time without notice.

No part of this manual may be reproduced, copied, translated, or transmitted in any form or by any means without the prior written permission of the original manufacturer. Information provided in this manual is intended to be accurate and reliable. However, the original manufacturer assumes no responsibility for its use, or for any infringements upon the rights of third parties that may result from its use.

The material in this document is for product information only and is subject to change without notice. While reasonable efforts have been made in the preparation of this document to assure its accuracy, GIGAIPC assumes no liabilities resulting from errors or omissions in this document, or from the use of the information contained herein.

GIGAIPC reserves the right to make changes in the product design without notice to its users.

Acknowledgement

All other products' name or trademarks are properties of their respective owners.

- AMD is trademark of Advanced Micro Devices.
- Microsoft Windows is a registered trademark of Microsoft Corp.
- Intel, Pentium, Celeron, and Xeon are registered trademarks of Intel Corporation
- Core, Atom are trademarks of Intel Corporation
- ITE is a trademark of Integrated Technology Express, Inc.
- IBM, PC/AT, PS/2, and VGA are trademarks of International Business Machines Corporation.

All other product names or trademarks are properties of their respective owners.

Packing List

Before setting up your product, please make sure the following items have been shipped:

Item	Quantity
COM Cable, waterproof (25CF8-1K8400-OOS)	3
USB 2.0 Cable, waterproof (25CFA-1K8000-OOR)	2
RJ45 Cable, waterproof (25CR0-1K8401-OOS)	2
SIGNAL Cable, waterproof (25CR5-1K8500-OOR)	1
HDMI Cable, waterproof (25CRC-180720-OOS)	1
DC JACK Cable, waterproof (25CRD-1K8300-OOS)	1
Wall mount (25HBA-826520-H5R)	2
Exsiccator (10g)	1

If any of these items are missing or damaged, please contact your distributor or sales representative immediately.

About this Document

This User's Manual contains all the essential information, such as detailed descriptions and explanations on the product's hardware and software features (if any), its specifications, dimensions, jumper/connector settings/definitions, and driver installation instructions (if any), to facilitate users in setting up their product.

Users may refer to the GIGAIPC.com for the latest version of this document.

Safety Precautions

Please read the following safety instructions carefully. It is advised that you keep this manual for future references

1. All cautions and warnings on the device should be noted.
2. Make sure the power source matches the power rating of the device.
3. Position the power cord so that people cannot step on it. Do not place anything over the power cord.
4. Always completely disconnect the power before working on the system's hardware.
5. No connections should be made when the system is powered as a sudden rush of power may damage sensitive electronic components.
6. If the device is not to be used for a long time, disconnect it from the power supply to avoid damage by transient over-voltage.
7. Always disconnect this device from any AC supply before cleaning.
8. While cleaning, use a damp cloth instead of liquid or spray detergents.
9. Make sure the device is installed near a power outlet and is easily accessible.
10. Keep this device away from humidity.
11. Place the device on a solid surface during installation to prevent falls
12. Do not cover the openings on the device to ensure optimal heat dissipation.

13. Watch out for high temperatures when the system is running.
14. Do not touch the heat sink or heat spreader when the system is running
15. Never pour any liquid into the openings. This could cause fire or electric shock.
16. As most electronic components are sensitive to static electrical charge, be sure to ground yourself to prevent static charge when installing the internal components. Use a grounding wrist strap and contain all electronic components in any static-shielded containers.
17. If any of the following situations arises, please the contact our service personnel:
 - i. Damaged power cord or plug
 - ii. Liquid intrusion to the device
 - iii. Exposure to moisture
 - iv. Device is not working as expected or in a manner as described in this manual
 - v. The device is dropped or damaged
 - vi. Any obvious signs of damage displayed on the device
18. **DO NOT LEAVE THIS DEVICE IN AN UNCONTROLLED ENVIRONMENT WITH TEMPERATURES BEYOND THE DEVICE'S PERMITTED STORAGE TEMPERATURES (SEE CHAPTER 1) TO PREVENT DAMAGE.**

FCC Statement

Warning!



This device complies with Part 15 FCC Rules. Operation is subject to the following two conditions: (1) this device may not cause harmful interference, and (2) this device must accept any interference received including interference that may cause undesired operation.

Caution:

There is a danger of explosion if the battery is incorrectly replaced. Replace only with the same or equivalent type recommended by the manufacturer. Dispose of used batteries according to the manufacturer's instructions and your local government's recycling or disposal directives.

Attention:

Il y a un risque d'explosion si la batterie est remplacée de façon incorrecte. Ne la remplacer qu'avec le même modèle ou équivalent recommandé par le constructeur. Recycler les batteries usées en accord avec les instructions du fabricant et les directives gouvernementales de recyclage.

High Temperature Warning

(1) This equipment is intended to be used in Restrict Access Location. The access can only be gained by Skilled person or by Instructed person who have been instructed about the metal chassis of the equipment is so hot that Skilled person have to pay special attention or take special protection.

Only authorized by well trained professional person can access the restrict access location.

(2) External metal parts are hot!! Before touching it, special attention or protection is necessary



Table Contents

QBiX-WP Waterproof Industrial Embedded System	1
Quick Start Guide	
Copyright Notice	2
Acknowledgement	3
Packing List.....	4
About this Document.....	5
Safety Precautions	6
FCC Statement.....	8
High Temperature Warning	8
Chapter 1 - Product Specifications	11
1.1 Specifications	13
Chapter 2 – QBiX-WP-APLA3940H-A1 (QW-3940A-SI)	15
Waterproof Industrial Embedded System Kit	
2.1 Dimension	16
2.2 Getting Familiar with Your Unit.....	17
2.3 COM 1 Connector for RS-232/422/485 & RI/5V/12V ...	19
2.4 COM 2/3 Connector for RS-232.....	19
2.5 DIO Connector	19
2.6 DC-IN Connector	20
2.7 LAN 1/2 Connectors	20
2.8 USB 1/2 Connectors for USB 2.0	20
2.9 HDMI 1.4 Connector	21
2.10 Support	22

2.11	Safety and Regulatory Information.....	23
------	--	----

Chapter 3 – Hardware Information **25**

3.1	Jumpers and Connectors	26
3.2.1	FAN (FAN connector)	29
3.2.2	DC IN (DC IN 1 x 4-pin power connector)	30
3.2.3	COM1, COM2, COM3, COM4 (Serial port header)	31
3.2.4	SPK_OUT (Speaker out connector)	32
3.2.5	JCOM11 (RI# pin RI#/5V/12V Select jumper for COM1 port)	33
3.2.6	JRS11-JRS14 (RS11-14 select jumper for serial port).....	34
3.2.7	AT_CN (AT/ATX power mode select jumper)	35
3.2.8	LSW (LVDS resolution jumper)	36
3.2.9	LVDS (LVDS connector).....	37
3.2.10	BKL_CN (Backlight brightness control connector).....	38
3.2.11	BUZZER.....	39
3.2.12	BATTERY	40
3.2.13	SATAPW (SATA power connector).....	41
3.2.14	SATAIII (SATA 6Gb/s Connector)	42
3.2.15	FUSB20_1, FUSB2_2 (USB 2.0 header).....	43
3.2.16	GPIO_CNT (General Purpose input/output header) ...	44
3.2.17	SYS_PANEL (Front panel header)	45
3.2.18	CLS_CMOS (Clean CMOS jumper).....	46

Chapter 1

Chapter 1 - Product Specifications

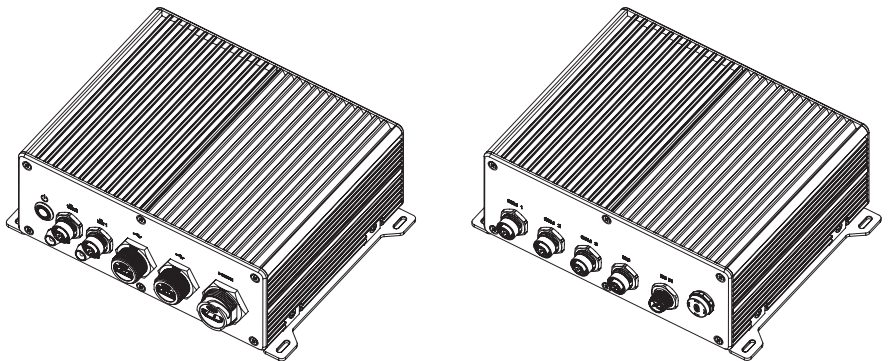

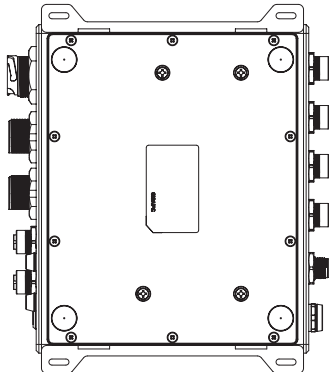
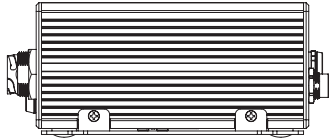
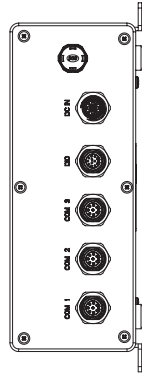
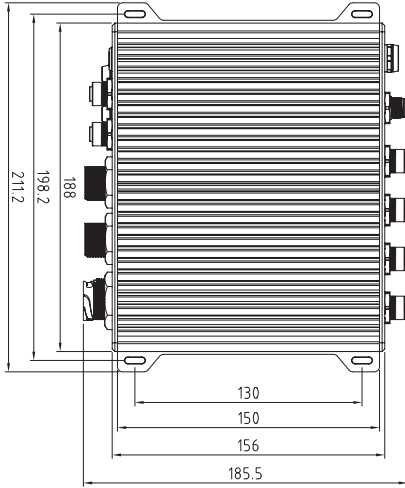
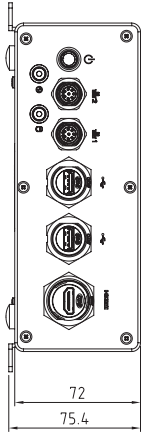

1.1 Specifications

System	QBiX-WP-APLA3940H-A1 (QW-3940A-SI)
Dimension	System Size : 188W x 155D x 72H (mm)
CPU	Intel® Atom® x5-E3940 Processor 14nm, 4 cores, 4 threads, up to 1.80 GHz TDP 9.5W
Chipset	SoC
Memory	2 x DDR3L SO-DIMM sockets, Max. Capacity 8 GB Support Dual channel DDR3L 1866 MHz memory modules (Integrated memory 8GB)
Ethernet	2 x GbE LAN Ports (Intel® I211AT)
Graphic support	Integrated Graphics Processor - Intel® HD Graphics 500: 1 x HDMI port, supporting a maximum resolution of 3840x2160 @30Hz
Audio	Realtek® Audio Codec
Storage	1 x 2.5" HDD/SSD (SATA 6Gb/s)
Expansion Slots	1 x 2242 M.2 M-Key (SATA 6Gb/s) 1 x Full-size Mini PCIe with SIM slot (PCIe x1 + USB2.0) -- support 3G/4G module (Integrated M.2 SSD 256GB)
Front I/O	2 x (M12) LAN Ports 2 x (IP67) USB 2.0 connector 1 x (IP67) HDMI connector 1 x (IP67) Power switch 1 x (M8) Power & HDD LED
Rear I/O	1 x (M12) COM Port (RS-232/422/485 & RI/5V/12V) 2 x (M12) COM Port (RS-232) 1 x (M12) GPIO (8 bits) 1 x (M12) DC Jack
TPM	—
Power	+9V~36VDC (Full Range)
Operation temperature	Operating temperature: -20°C to 80°C Operating humidity: 0-90% (non-condensing) Non-operating temperature: -20°C to 70°C Non-operating humidity: 0%-95% (non-condensing) Use wide temperature range memory and storage

System	QBIX-WP-APLA3940H-A1 (QW-3940A-SI)
Vibration During Operation	Operation: IEC 60068-2-64, 3 Grms, random, 5 ~ 500 Hz, 1 hr / Per Axis, With SSD/M.2 2242 Non-operation: IEC 60068-2-6, 2 G, Sine, 10 ~ 500 Hz, 1 Oct/min, 1 hr / Per Axis
Shock During Operation	Operation: IEC 60068-2-27, 50 G, half sine, 11 ms duration, with SSD
Packaging Content	Carton size: 305 x 285 x 265 (mm) Packing Capacity: 1pc Including: COM Cable, waterproof, x 3 (P/N: 25CF8-1K8400-O0S) USB 2.0 Cable, waterproof, x 2 (P/N: 25CFA-1K8000-O0R) RJ45 Cable, waterproof, x 2 (P/N: 25CRO-1K8401-O0S) SIGNAL Cable, waterproof, x 1 (P/N: 25CR5-1K8500-O0R) HDMI Cable, waterproof, x 1 (P/N: 25CRC-180720-O0S) DC JACK Cable, waterproof, x 1 (P/N: 25CRD-1K8300-O0S) Wall mount bracket (P/N: 25HBA-826520-H5R)
Order Information	System: 9BQW3940AMR-SI (Box packing) (Built in Components: Please contact with your sales representative for more information or e-mailed to : sales@gigaipc.com)

Chapter 2

Chapter 2 – QBiX-WP-APLA3940H-A1 (QW-3940A-SI) Waterproof Industrial Embedded System Kit

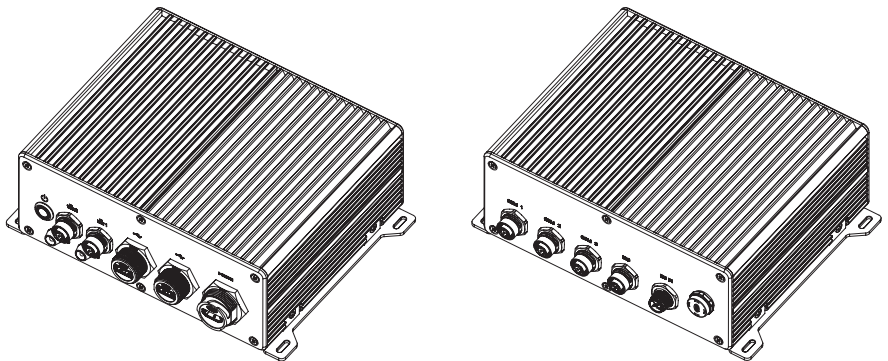

2.1 Dimension

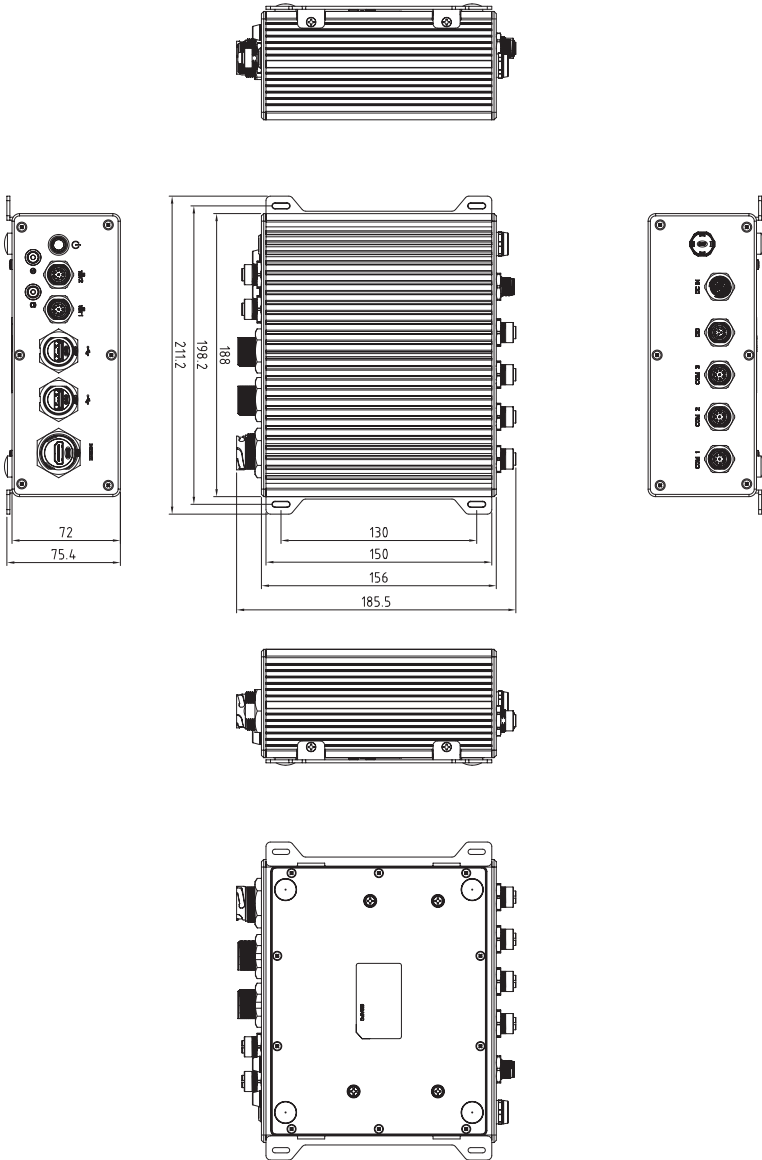

2.2 Getting Familiar with Your Unit

[Front Side]

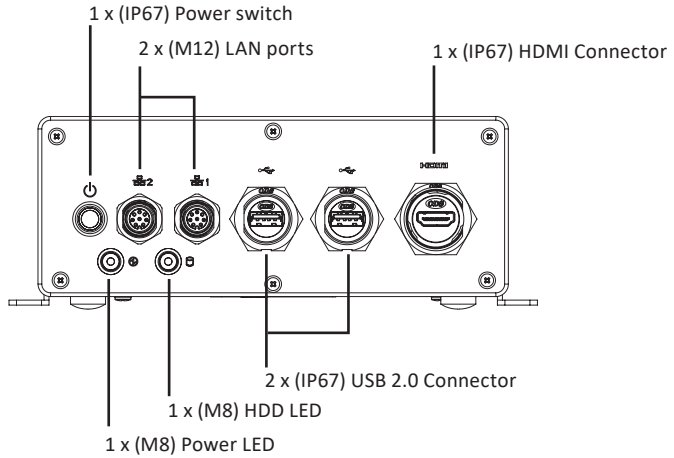

[Rear Side]

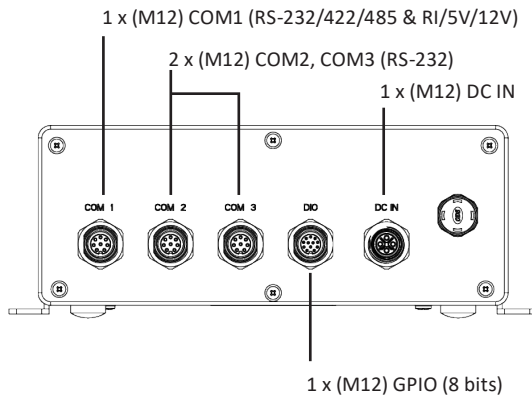

[Left Side]

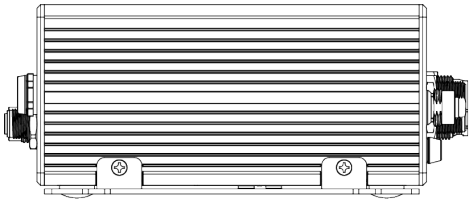

[Right Side]

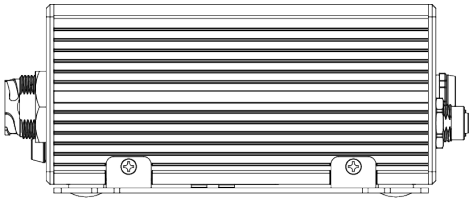

[Bottom Side]

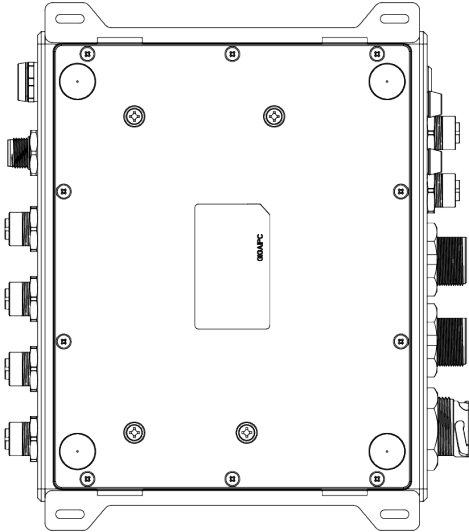

2.3 COM 1 Connector for RS-232/422/485 & RI/5V/12V

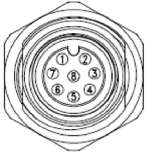

Pin Assignments
Front View

Pin No.	Pin Define	Pin No.	Pin Define
1	DCD	6	RTS
2	RXD	7	CTS
3	TXD	8	RI
4	DTR	Shield	GND
5	DSR	—	—

2.4 COM 2/3 Connector for RS-232

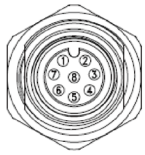

Pin Assignments
Front View

Pin No.	Pin Define	Pin No.	Pin Define
1	DCD	6	RTS
2	RXD	7	CTS
3	TXD	8	RI
4	DTR	Shield	GND
5	DSR	—	—

2.5 DIO Connector

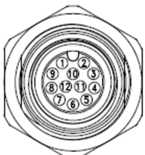

Pin Assignments
Front View

Pin No.	Pin Define	Pin No.	Pin Define
1	GPO1	7	GPO4
2	GPI1	8	GPI4
3	GPO2	9	SMB_CLK
4	GPI2	10	SMB_DATA
5	GPO3	11	5V/ 1A
6	GPI3	—	—

2.6 DC-IN Connector

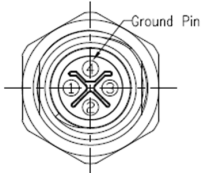

Pin Assignments
Front View

Pin No.	Pin Define
1	V-
2	V+
3	
4	Chassis Ground

2.7 LAN 1/2 Connectors

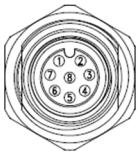

Pin Assignments
Front View

Pin No.	Pin Define	Pin No.	Pin Define
1	TX +	5	No Signal
2	TX -	6	RX-
3	RX+	7	No Signal
4	No Signal	8	No Signal

2.8 USB 1/2 Connectors for USB 2.0

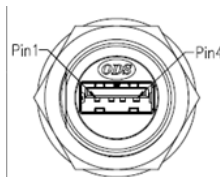

Conn.1 & Conn.2 Pin Assignments Front View

2.9 HDMI 1.4 Connector

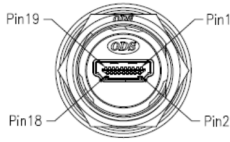

**Pin Assignments
Front View**

Pin No.	Pin Define	Pin No.	Pin Define
1	D2+	10	Clock+
2	D2 / Shield	11	Clock / Shield
3	D2-	12	Clock-
4	D1+	13	CEC
5	D1 / Shield	14	Utility
6	D1-	15	SCL
7	D0+	16	SDA
8	D0 / Shield	17	GND
9	D0-	18	5V+ Power
—	—	19	Hot Plug Detect

2.10 Support

- For a list of tested memory, M.2, 2.5'' SSD, wireless adapters and OS supported, go to: <http://www.gigaipc.com>
- To download the latest drivers and BIOS updates, go to: <http://www.gigaipc.com>
- For product support, go to: <http://www.gigaipc.com>

2.11 Safety and Regulatory Information

Risk of explosion if the battery is replaced with an incorrect type. Batteries should be recycled where possible.

Disposal of used Batteries must be in accordance with local environmental regulations.

Failure to use the included Power Adapter may violate regulatory compliance and may expose the user to safety hazards.

HDMI™
HIGH DEFINITION MULTIMEDIA INTERFACE



At the end of its serviceable life, this product should not be treated as household or general waste. It should be handed over to the applicable collection point for the recycling of electrical and electronic equipment, or returned to the supplier for disposal.

Chapter 3

Chapter 3 – Hardware Information

3.1 Jumpers and Connectors

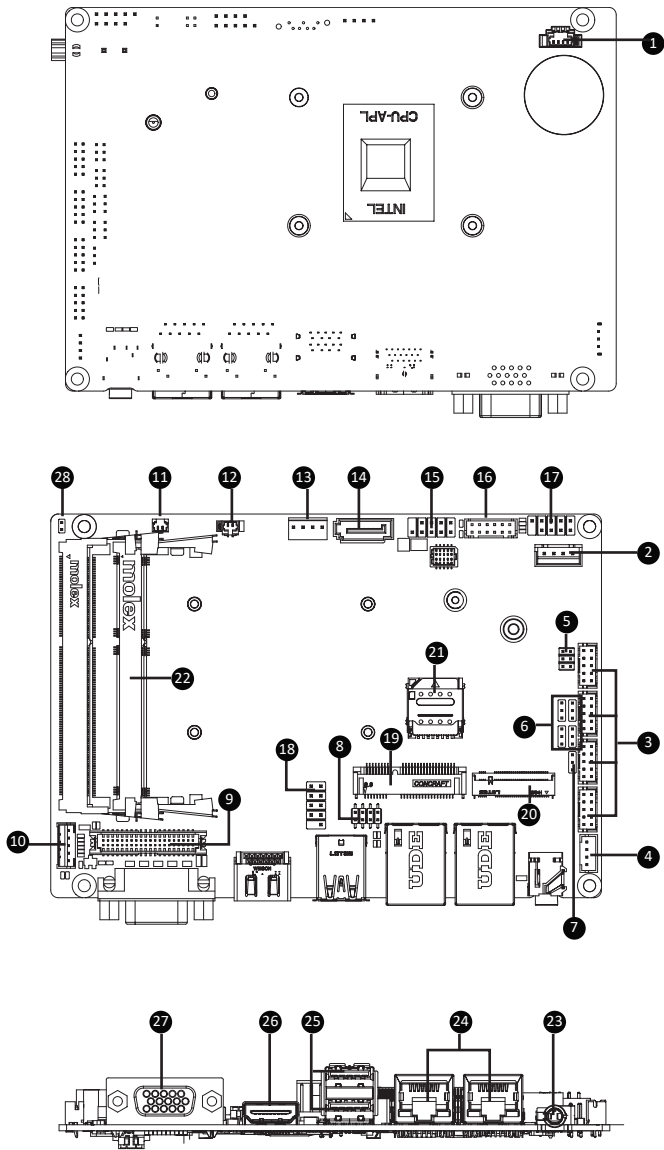

No	Code	Description
1	FAN	FAN connector
2	DC_IN	DC IN 1x4pin power connector
3	COM1 COM2 COM3 COM4	Serial port header COM1 : RS-232/422/485 & RI/5V/12V COM2, COM3, COM4 : RS-232
4	SPK_OUT	Speaker out connector
5	JCOM11	RI# pin RI#/5V/12V Select jumper for COM1 port
6	JRS11-JRS14	RS11-14 select jumper for serial port
7	AT_CN	AT/ATX power mode select jumper
8	LSW	LVDS resolution jumper
9	LVDS	LVDS connector
10	BKL_CN	Backlight brightness control connector
11	BUZZER	—
12	BATTERY	Battery cable connector
13	SATAPW	SATA power connector
14	SATAIII	SATA 6Gb/s Connector
15	FUSB20_1	USB 2.0 header
16	GPIO_CNT	General Purpose input/output header
17	SYS_PANEL	Front panel header
18	FUSB2_2	USB 2.0 header
19	MPCIE	Mini-PCIe slot
20	M2M	M.2 slot
21	SIM_CARD1	3G/4G Sim Slot

No	Code	Description
22	SODIMMA/B	2 x DDR3L SO-DIMM sockets, Max. Capacity 8 GB Dual channel memory architecture Support DDR3L 1866MHz memory modules
23	Audio jack	Line out
24	LAN1, LAN2	2 x RJ45 Ports
25	FUSB30	2 x USB3.0 Ports
26	HDMI	1 x HDMI Port
27	VGA	1 x VGA Port
28	CLS_CMOS	1 x Clear CMOS jumper

3.2.1 FAN (FAN connector)

1

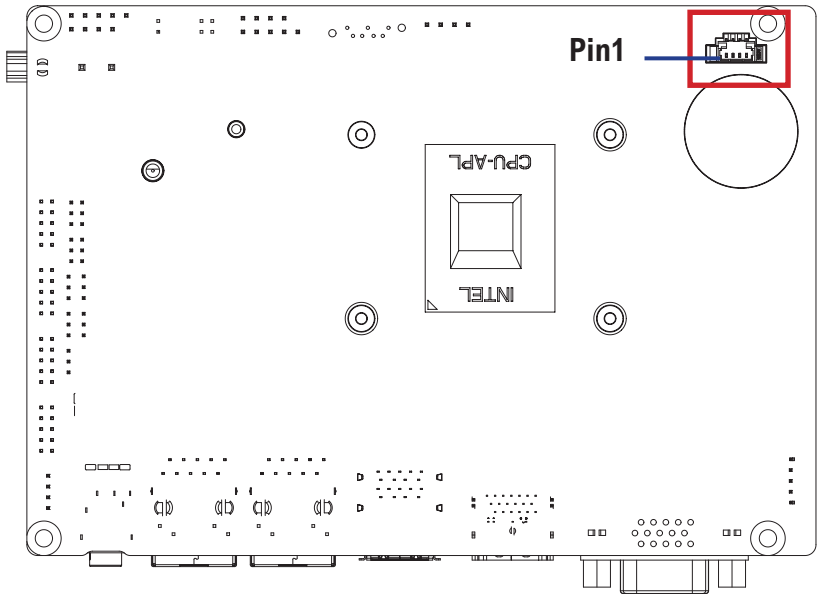

CPU/System FAN

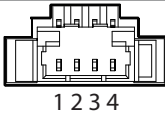

1 2 3 4

Connector PN	Vendor
85205-0470N	ACES
A1250WV-S-04PC	JOINT-TECH

Pin No.	Definition
1	GND
2	12V
3	Detect
4	Speed Control

3.2.2 DC IN (DC IN 1 x 4-pin power connector)

2

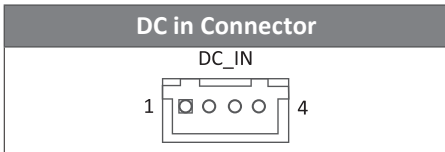
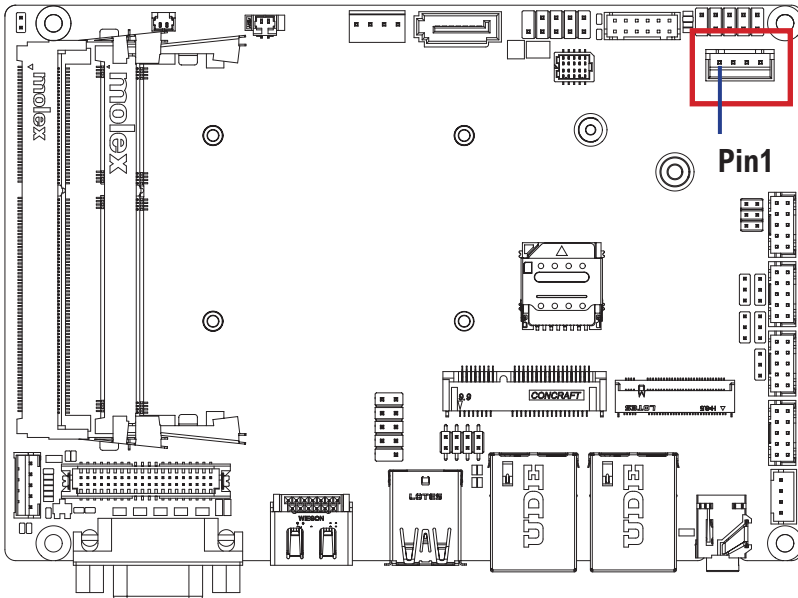

Connector PN	Vendor
753-81-04TW00	PINREX

Pin No.	Definition
1	GND
2	DCIN
3	DCIN
4	GND

3.2.3 COM1, COM2, COM3, COM4 (Serial port header)

3

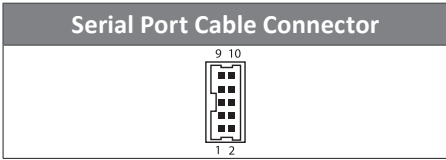
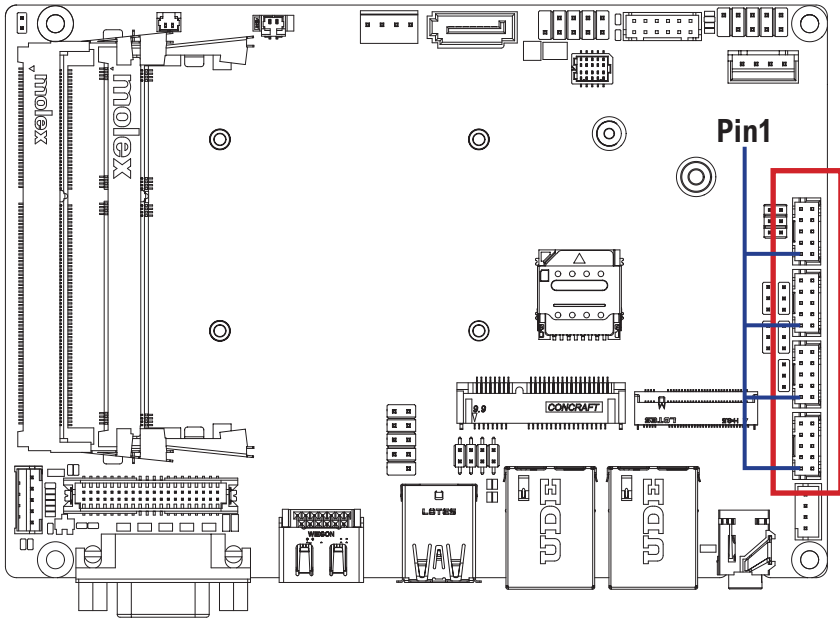

Connector PN	Vendor
725-81-10TW00	PINREX
A2004WV-2X05P46	JOINT-TECH

Pin No.	RS-232	RS-422 Full Duplex	RS-485 Half Duplex
1	RXD	TXD+	D+
2	DCD	TXD-	D-
3	DTR	RXD-	-
4	TXD	RXD+	-
5	DSR	-	-
6	GND	-	-
7	CTS	-	-
8	RTS	-	-
9	No Connect	-	-
10	RI/5V/12V	-	-

Note :
 COM1 : Support RS-232/422/485 & RI/5V/12V
 For RI/5V/12V jumper setting, please see P. 29
 COM2, COM3, COM4 : Support RS-232 only

3.2.4 SPK_OUT (Speaker out connector)

4

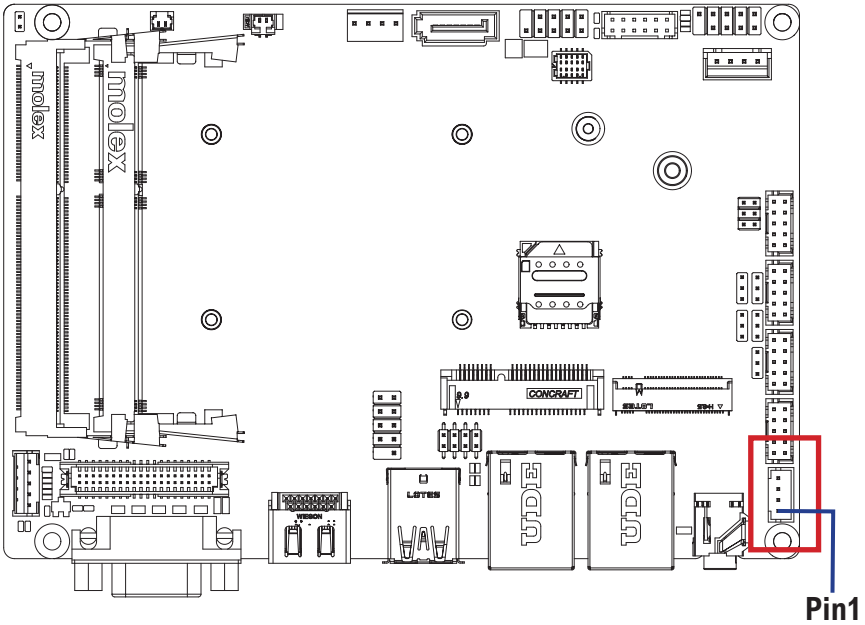

Speaker out connector	
4	
	1

Connector PN	Vendor
721-81-045W00	PINREX
A2001WV-04P146	JOINT-TECH

Pin No.	Definition
1	Speaker Out R+
2	Speaker Out R-
3	Speaker Out L-
4	Speaker Out L+

3.2.5 JCOM11 (RI# pin RI#/5V/12V Select jumper for COM1 port)

5

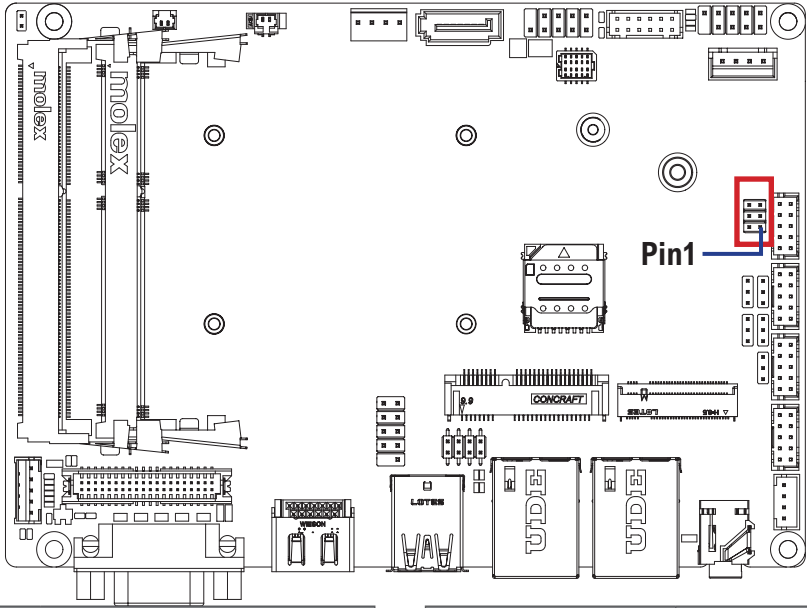

JCOM11 Jumper Select	
	1-2 Close: 5V (Power COM)
	3-4 Close: RI (Stand COM)
	5-6 Close: 12V (Power COM)

Connector PN	Vendor
220-97-03GB01	PINREX
PH06N53BAZ000	HORNGTONG

3.2.6 JRS11-JRS14 (RS11-14 select jumper for serial port)

6

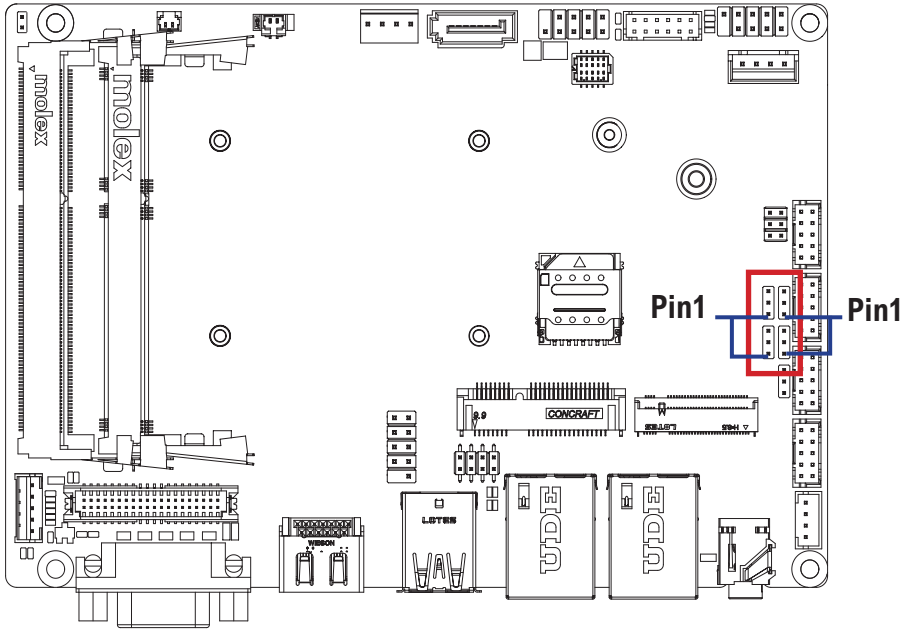

JRS 11-14 Jumper			
JRS13	JRS14		
		123	
		123	
JRS12	JRS11		
RS-232 (Default)			

Connector PN	Vendor
220-96-03GB01	PINREX
PH03N2-7BAN000	HORNGTONG

HW jump Configuration
Pin1, Pin2 Close is 1
Pin2, Pin3 Close is 0

JRS11	JRS12	JRS13	Mode	Status
0	0	0	RS-422 Full Duplex	1T/1R RS-422
0	0	1	Pure RS-232	3T/5R RS-232 (Default)
0	1	0	RS-485 Half Duplex	1T/1R RS-485, TX ENABLE Low Active
0	1	1	RS-485 Half Duplex	1T/1R RS-485, TX ENABLE High Active

3.2.7 AT_CN (AT/ATX power mode select jumper)

7

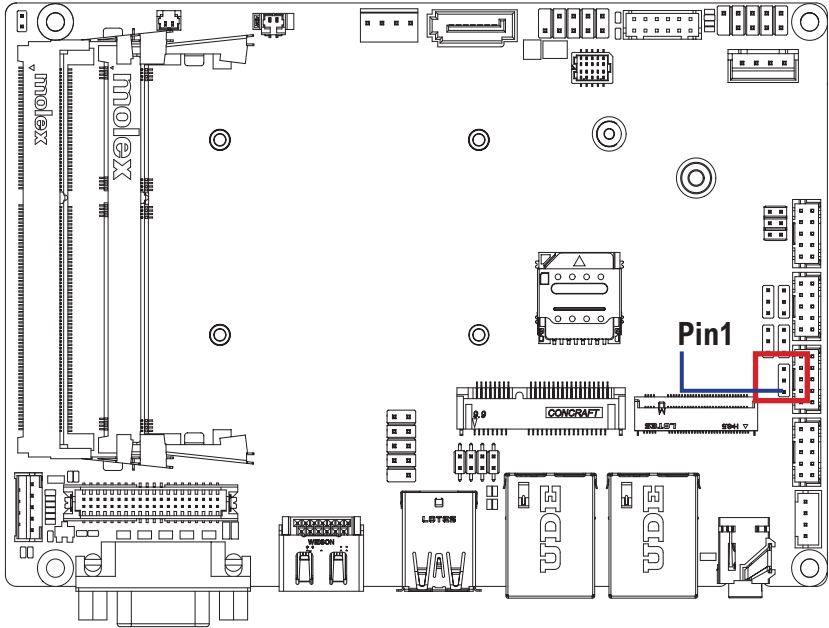

AT/ATX power mode select jumper



- 1-2 Close : AT mode.
- 2-3 Close : ATX mode.
(Default setting)

Connector PN

- 220-96-03GB01
- PH03N2-7BAN000

Vendor

- PINREX
- HORNGTONG









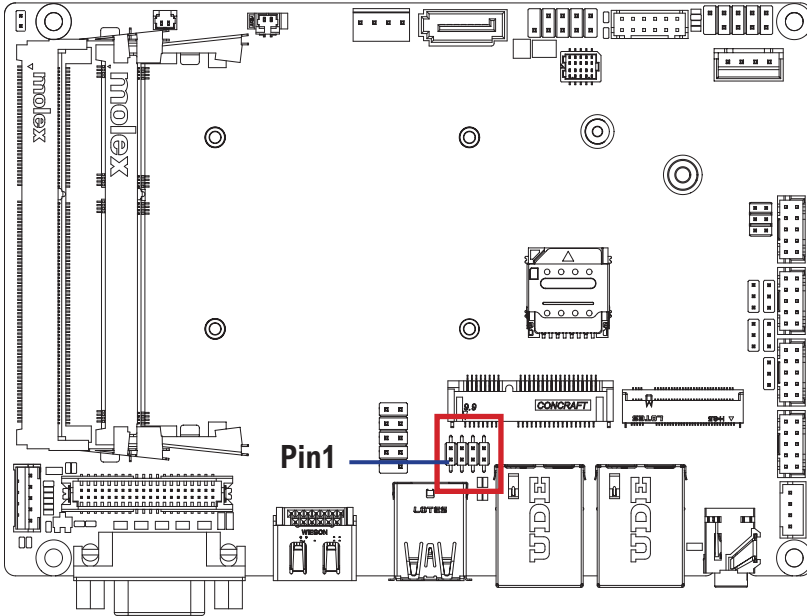







Pin No. Definition

Pin No.	Definition
1	AT MODE
2	Detect
3	ATX MODE

3.2.8 LSW (LVDS resolution jumper)

8



LVDS Resolution Jumper			
Jumper Setting	Resolution	Jumper Setting	Resolution
1 	800 x 600 18bit (default)	1 	1366 x 768 24bit
1 	1024 x 768 18bit	1 	1440 x 900 24bit
1 	1024 x 768 24bit	1 	1400 x 1050 24bit
1 	1024 x 600 18bit	1 	1600 x 900 24bit
1 	1280 x 800 18bit	1 	1680 x 1050 24bit
1 	1280 x 960 18bit	1 	1600 x 1200 24bit
1 	1280 x 1024 24bit	1 	1920 x 1080 24bit
1 	1366 x 768 18bit	1 	1920 x 1200 24bit

Connector PN	Vendor
222-97-04GBE1	PINREX

3.2.9 LVDS (LVDS connector)

9

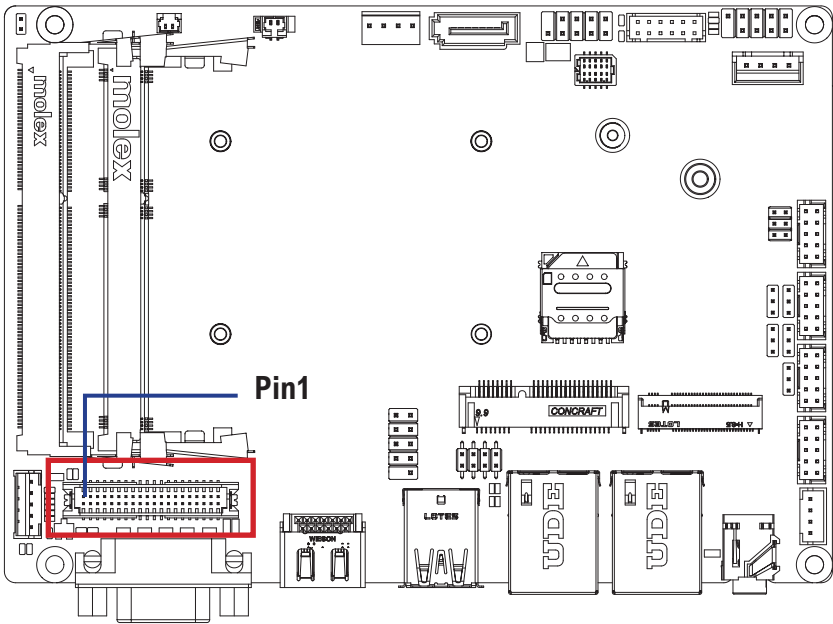

LVDS Connector

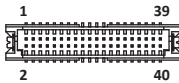

Pin No.	Definition	Pin No.	Definition
17	A3-	37	GND
18	A2-	38	GND
19	GND	39	12V
20	GND	40	12V

Pin No.	Definition	Pin No.	Definition
1	3.3V	21	A5+
2	5V	22	A4+
3	3.3V	23	A5-
4	5V	24	A4-
5	SPE0	25	GND
6	SPE0	26	GND
7	GND	27	A7+
8	GND	28	A6+
9	A1+	29	A7-
10	A0+	30	A6-
11	A1-	31	GND
12	A0-	32	GND
13	GND	33	CLK2+
14	GND	34	CLK1+
15	A3+	35	CLK2-
16	A2+	36	CLK1-

For each model support LVDS function.

But below model no need to add.

A0~A3 is odd channel 0~3, A4~A7 is even channel.

Connector PN	Vendor
712-76-40GWE0	PINREX
A1252WV-SF-2X20PD01	JOINT-TECH

Note: *The LVDS output connector of the unit is only intended to be connected to an UL/IEC/EN approval equipment with fire enclosure.

3.2.10 BKL_CN (Backlight brightness control connector)

10

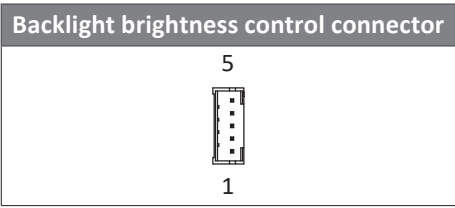
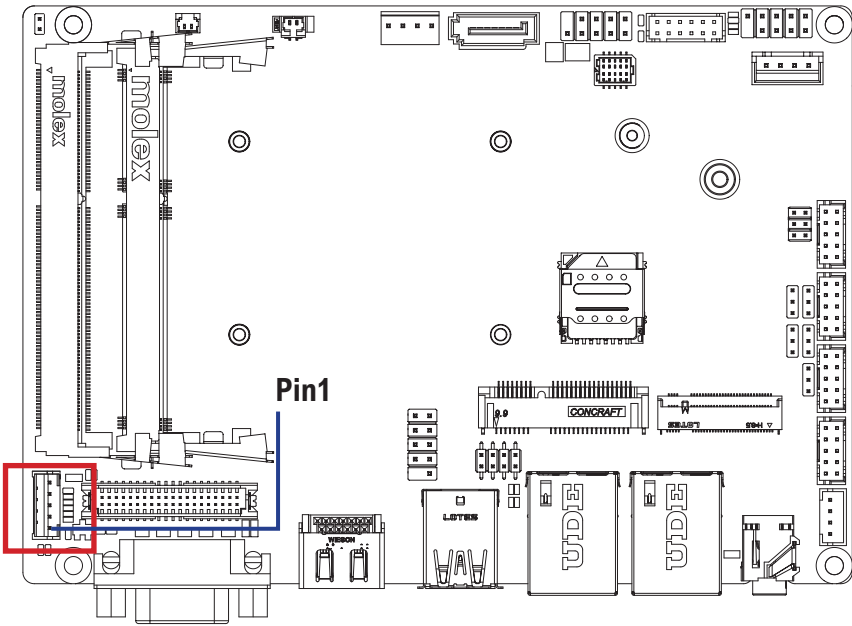

Connector PN	Vendor
721-81-05TW00	PINREX
A2001WV-05P146	JOINT-TECH

Pin No.	Definition
1	5V
2	PWM
3	Back Light Enable
4	GND
5	12V

3.2.11 BUZZER

11

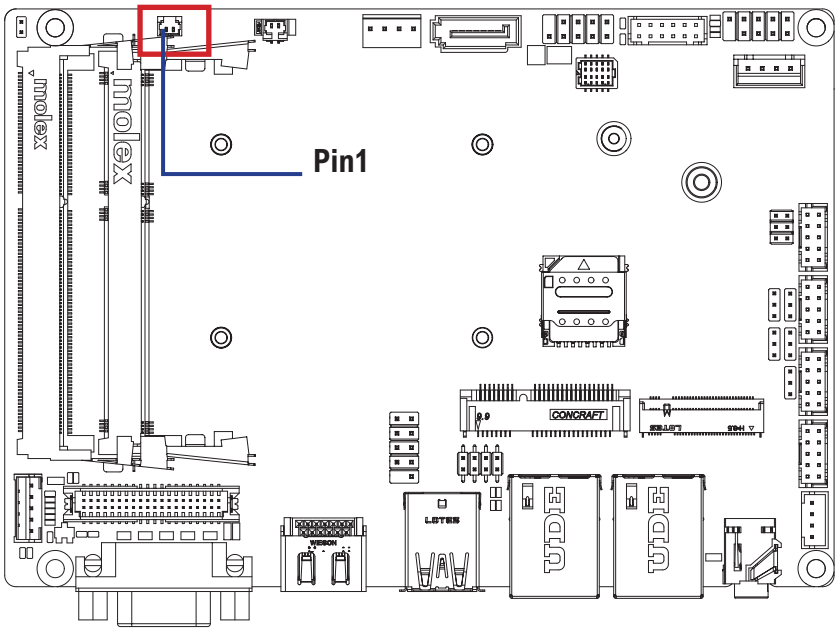

Buzzer



Connector PN

712-71-02TW01

A1250WV-02P

Vendor

PINREX

JOINT-TECH

Pin No.

Definition

1

-SPKR

2

+VS5

3.2.12 BATTERY

12

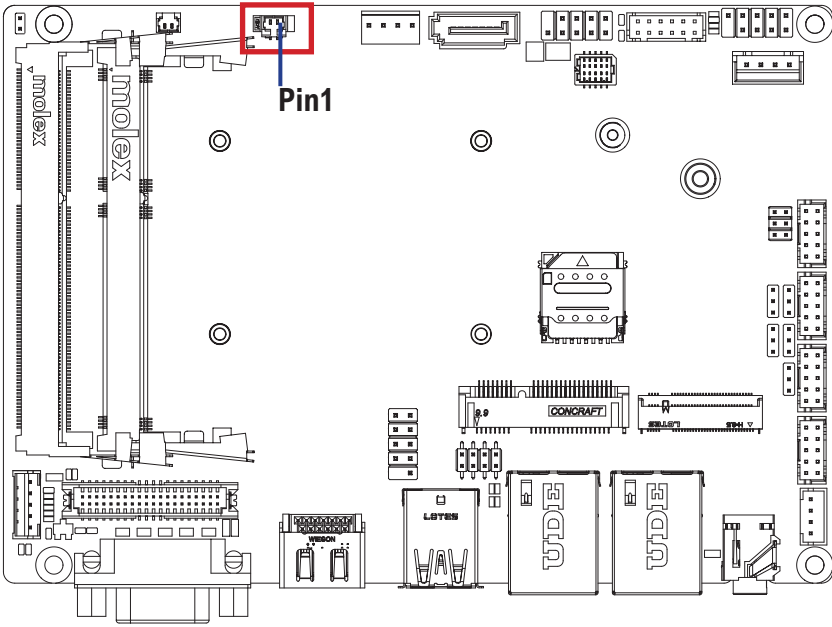

Battery Cable Connector	
2	1

Connector PN	Vendor
85205-0270L	ACES
A1250WV-S-02PC	JOINT-TECH

Pin No.	Definition
1	3.3V RTC
2	GND

3.2.13 SATAPW (SATA power connector)

13

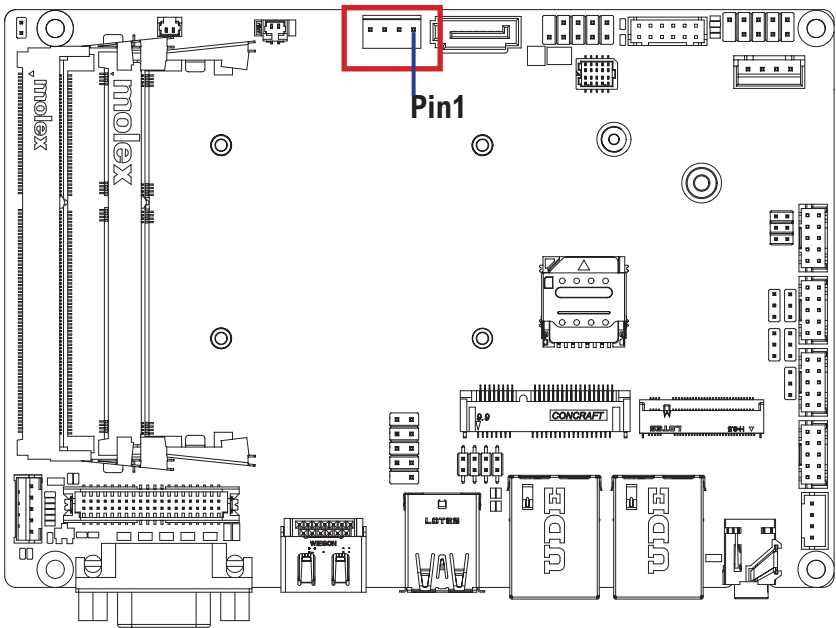

Hard Disk Power Connector



Connector PN

743-81-04TW00

WF04Q2-3BJQ000

Vendor

PINREX

HORNGTONG

Pin No. Definition

1	+12V
2	GND
3	GND
4	VCC

3.2.14 SATAIII (SATA 6Gb/s Connector)

14

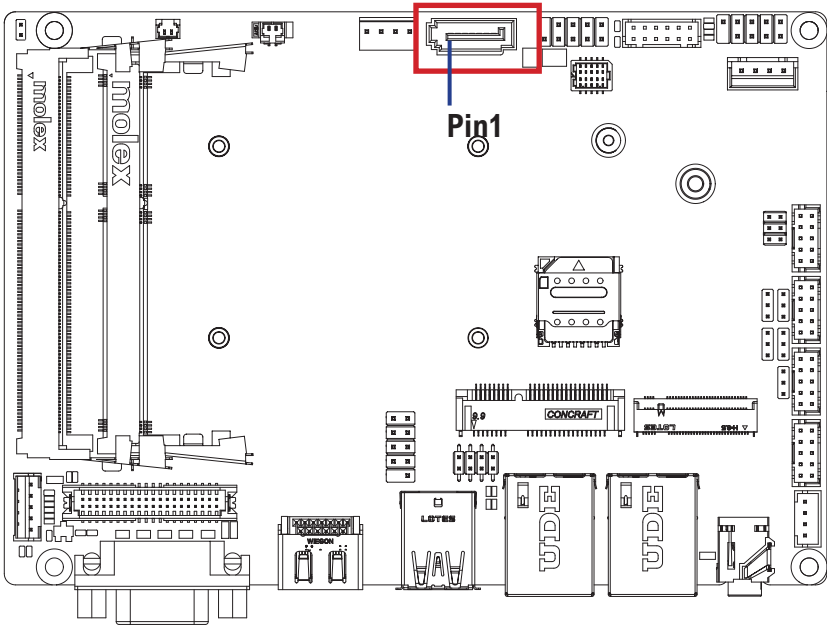

SATA 6GB/S Connector

SATAIII	
Connector PN	Vendor
WAT3M-07A1G3BU4W	WINWIN
ABA-SAT-054-S15	LOTES

Pin No.	Definition
1	GND
2	TXp
3	TXn
4	GND
5	RXn
6	RXp
7	GND

3.2.15 FUSB20_1, FUSB20_2 (USB 2.0 header)

15 18

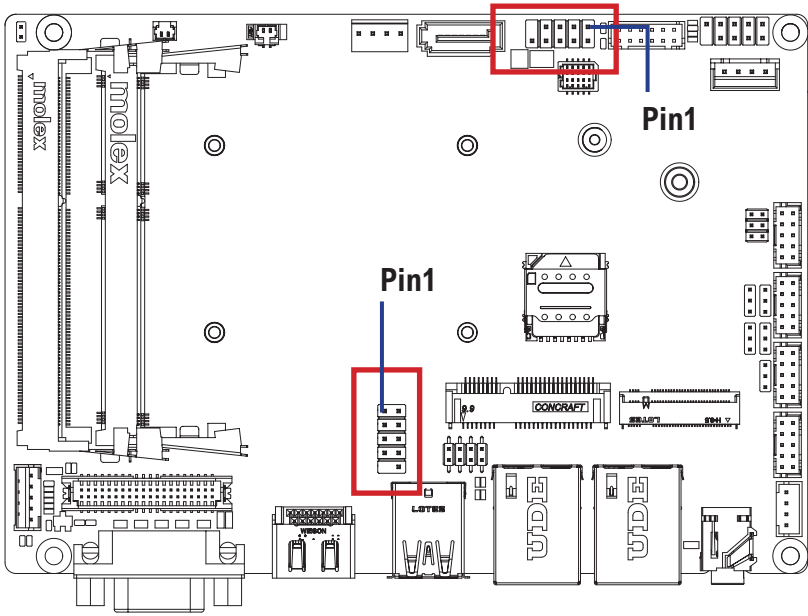

USB 2.0 Header



Connector PN

210-92-05GB04

PH10R53BAZ009

Vendor

PINREX

HORNGTONG

Pin No. Definition

Pin No.	Definition
1	5V
2	5V
3	DX-
4	DY-
5	DX+
6	DY+
7	GND
8	GND
9	No Pin
10	No Connect

3.2.16 GPIO_CNT (General Purpose input/output header)

16

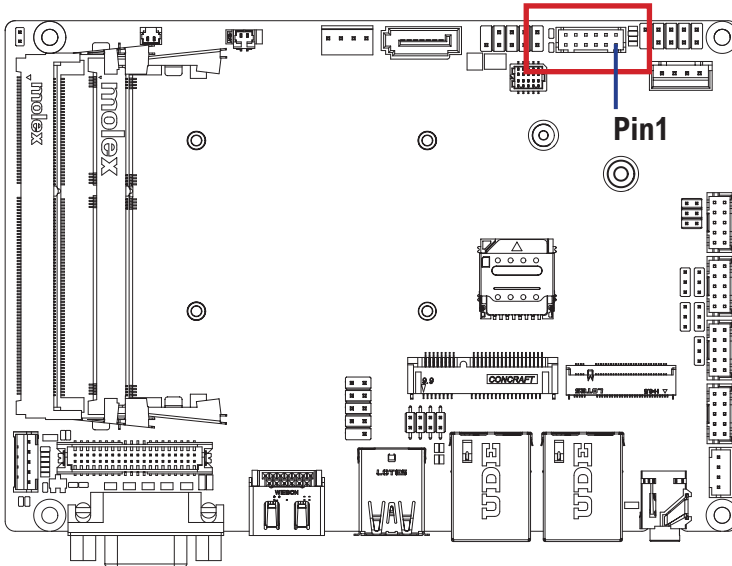

GPIO Connector	
12	2
11	1

Connector PN	Vendor
725-81-12TW00	PINREX
A2004WV-2X06P46	JOINT-TECH

Pin No.	Definition
1	GPIO-output_1
2	GPIO-input_1
3	GPIO-output_2
4	GPIO-input_2
5	GPIO-output_3
6	GPIO-input_3
7	GPIO-output_4
8	GPIO-input_4
9	SMBus Clock
10	SMBus DATA
11	5V
12	GND

3.2.17 SYS_PANEL (Front panel header)

17

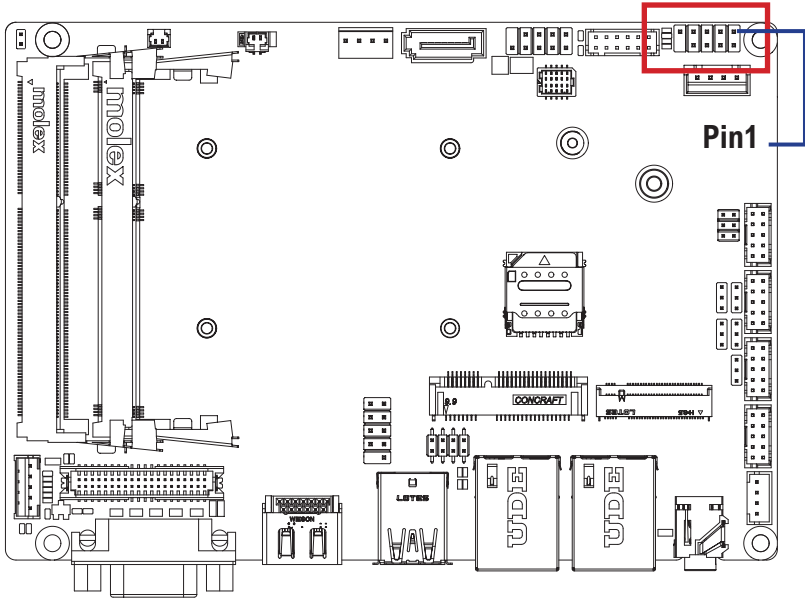

System Panel Header



Connector PN

210-92-05G111

Vendor

PINREX

Pin No. **Definition**

1	HDD LED+
2	Power LED+
3	HDD LED-
4	Power LED-
5	GND
6	Power Button+
7	Reset Button
8	Power Button-
9	No Connect
10	No Pin

3.2.18 CLS_CMOS (Clean CMOS jumper)

28

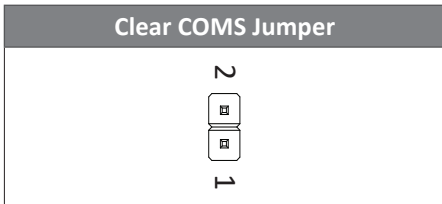
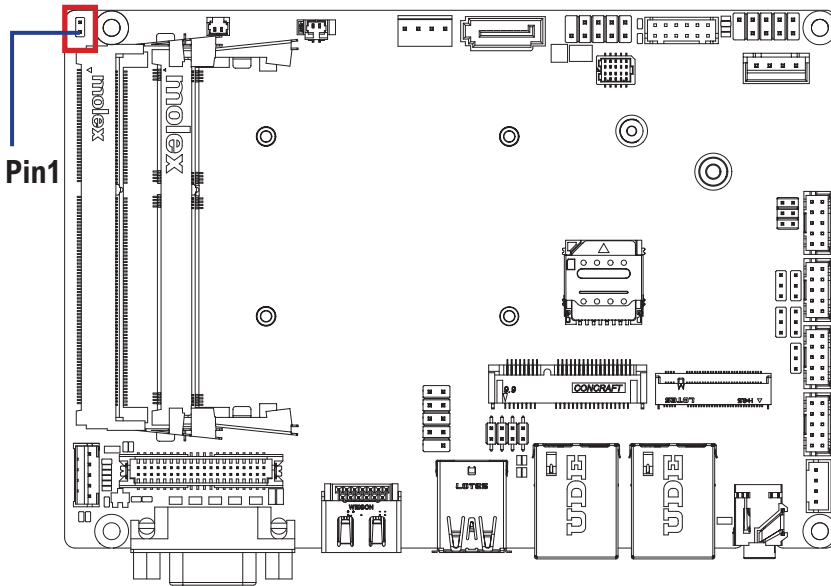

Pin No.	Definition
	Open: Normal Operation (Default setting)
	Close: Clear COMS data.

Pin No.	Definition
1	Clear CMOS
2	GND

Connector PN	Vendor
210-91-02GB01	PINREX
PH02R23BAZ000	HORNGTONG